

## LP2987/LP2988

# Micropower, 200 mA Ultra Low-Dropout Voltage Regulator with Programmable Power-On Reset Delay; Low Noise Version Available (LP2988)

### General Description

The LP2987/8 are fixed-output 200 mA precision LDO voltage regulators with power-ON reset delay which can be implemented using a single external capacitor.

The LP2988 is specifically designed for noise-critical applications. A single external capacitor connected to the Bypass pin reduces regulator output noise.

Using an optimized VIP™ (Vertically Integrated PNP) process, these regulators deliver superior performance:

**Dropout Voltage:** 180 mV @ 200 mA load, and 1 mV @ 1 mA load (typical).

**Ground Pin Current:** 1 mA @ 200 mA load, and 200  $\mu$ A @ 10 mA load (typical).

**Sleep Mode:** The LP2987/8 draws less than 2  $\mu$ A quiescent current when shutdown pin is held low.

**Error Flag/Reset:** The error flag goes low when the output drops approximately 5% below nominal. This pin also provides a power-ON reset signal if a capacitor is connected to the DELAY pin.

**Precision Output:** Standard product versions of the LP2987 and LP2988 are available with output voltages of 5.0V, 3.8V, 3.3V, 3.2V, 3.0V, or 2.8V, with guaranteed accuracy of 0.5% ("A" grade) and 1% (standard grade) at room temperature.

### Features

- Ultra low dropout voltage
- Power-ON reset delay requires only one component
- Bypass pin for reduced output noise (LP2988)
- Guaranteed continuous output current 200 mA
- Guaranteed peak output current > 250 mA
- SO-8 and mini SO-8 surface mount packages
- <2  $\mu$ A quiescent current when shutdown
- Low ground pin current at all loads
- 0.5% output voltage accuracy ("A" grade)
- Wide supply voltage range (16V max)
- Overtemperature/overcurrent protection
- -40°C to +125°C junction temperature range

### Applications

- Cellular Phone
- Palmtop/Laptop Computer
- Camcorder, Personal Stereo, Camera

### Block Diagrams

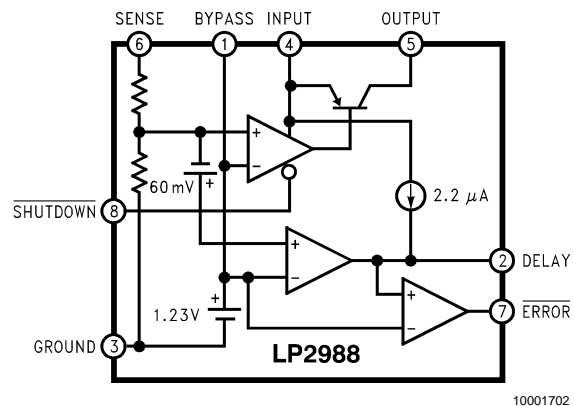
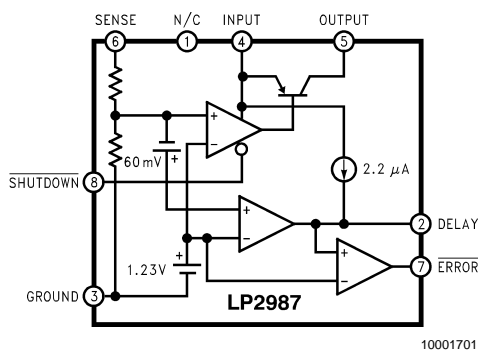

VIP™ is a trademark of National Semiconductor Corporation.

## Connection Diagram (LP2987)

### Surface Mount Packages:

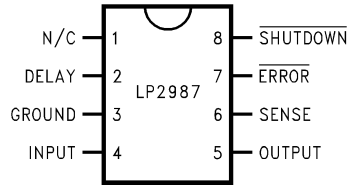

Top View

### SO-8/Mini SO-8 Package

See NS Package Drawing Number M08A/MUA08A  
For ordering information, refer to *Table 1* in this document.

### 8-Lead LLP Surface Mount Package

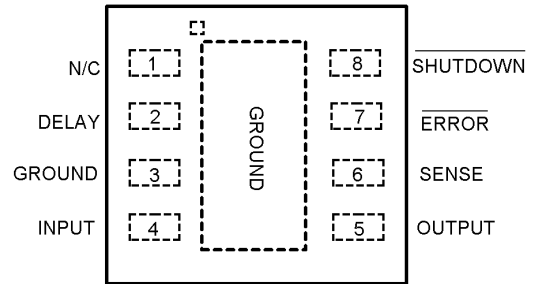

Top View

See NS Package Drawing Number LDC08A

## Ordering Information (LP2987)

TABLE 1. Package Marking and Ordering Information

Output Voltage	Grade	Order Information	Package Marking	Supplied as:
5	A	LP2987AIMMX-5.0	L44A	3500 Units on Tape and Reel
5	A	LP2987AIMM-5.0	L44A	1000 Units on Tape and Reel
5	STD	LP2987IMMX-5.0	L44B	3500 Units on Tape and Reel
5	STD	LP2987IMM-5.0	L44B	1000 Units on Tape and Reel
3.8	A	LP2987AIMMX-3.8	L96A	3500 Units on Tape and Reel
3.8	A	LP2987AIMM-3.8	L96A	1000 Units on Tape and Reel
3.8	STD	LP2987IMMX-3.8	L96B	3500 Units on Tape and Reel
3.8	STD	LP2987IMM-3.8	L96B	1000 Units on Tape and Reel
3.3	A	LP2987AIMMX-3.3	L43A	3500 Units on Tape and Reel
3.3	A	LP2987AIMM-3.3	L43A	1000 Units on Tape and Reel
3.3	STD	LP2987IMMX-3.3	L43B	3500 Units on Tape and Reel
3.3	STD	LP2987IMM-3.3	L43B	1000 Units on Tape and Reel
3.2	A	LP2987AIMMX-3.2	L66A	3500 Units on Tape and Reel
3.2	A	LP2987AIMM-3.2	L66A	1000 Units on Tape and Reel
3.2	STD	LP2987IMMX-3.2	L66B	3500 Units on Tape and Reel
3.2	STD	LP2987IMM-3.2	L66B	1000 Units on Tape and Reel
3.0	A	LP2987AIMMX-3.0	L42A	3500 Units on Tape and Reel

**Ordering Information (LP2987)** (Continued)**TABLE 1. Package Marking and Ordering Information** (Continued)

Output Voltage	Grade	Order Information	Package Marking	Supplied as:
3.0	A	LP2987AIMM-3.0	L42A	1000 Units on Tape and Reel
3.0	STD	LP2987IMMX-3.0	L42B	3500 Units on Tape and Reel
3.0	STD	LP2987IMM-3.0	L42B	1000 Units on Tape and Reel
2.8	A	LP2987AIMMX-2.8	L89A	3500 Units on Tape and Reel
2.8	A	LP2987AIMM-2.8	L89A	1000 Units on Tape and Reel
2.8	STD	LP2987IMMX-2.8	L89B	3500 Units on Tape and Reel
2.8	STD	LP2987IMM-2.8	L89B	1000 Units on Tape and Reel
5	A	LP2987AIMX-5.0	2987AIM5.0	2500 Units on Tape and Reel
5	A	LP2987AIM-5.0	2987AIM5.0	Shipped in Anti-Static Rails
5	STD	LP2987IMX-5.0	2987IM5.0	2500 Units on Tape and Reel
5	STD	LP2987IM-5.0	2987IM5.0	Shipped in Anti-Static Rails
3.8	A	LP2987AIMX-3.8	2987AIM3.8	2500 Units on Tape and Reel
3.8	A	LP2987AIM-3.8	2987AIM3.8	Shipped in Anti-Static Rails
3.8	STD	LP2987IMX-3.8	2987IM3.8	2500 Units on Tape and Reel
3.8	STD	LP2987IM-3.8	2987IM3.8	Shipped in Anti-Static Rails
3.3	A	LP2987AIMX-3.3	2987AIM3.3	2500 Units on Tape and Reel
3.3	A	LP2987AIM-3.3	2987AIM3.3	Shipped in Anti-Static Rails
3.3	STD	LP2987IMX-3.3	2987IM3.3	2500 Units on Tape and Reel
3.3	STD	LP2987IM-3.3	2987IM3.3	Shipped in Anti-Static Rails
3.2	A	LP2987AIMX-3.2	2987AIM3.2	2500 Units on Tape and Reel
3.2	A	LP2987AIM-3.2	2987AIM3.2	Shipped in Anti-Static Rails
3.2	STD	LP2987IMX-3.2	2987IM3.2	2500 Units on Tape and Reel
3.2	STD	LP2987AIM-3.2	2987IM3.2	Shipped in Anti-Static Rails
3.0	A	LP2987IMX-3.0	2987AIM3.0	2500 Units on Tape and Reel
3.0	A	LP2987AIM-3.0	2987AIM3.0	Shipped in Anti-Static Rails

**Ordering Information (LP2987)** (Continued)**TABLE 1. Package Marking and Ordering Information** (Continued)

Output Voltage	Grade	Order Information	Package Marking	Supplied as:
3.0	STD	LP2987IMX-3.0	2987IM3.0	2500 Units on Tape and Reel
3.0	STD	LP2987IM-3.0	2987IM3.0	Shipped in Anti-Static Rails
2.8	A	LP2987AIMX-2.8	2987AIM2.8	2500 Units on Tape and Reel
2.8	A	LP2987AIM-2.8	2987AIM2.8	Shipped in Anti-Static Rails
2.8	STD	LP2987IMX-2.8	2987IM2.8	2500 Units on Tape and Reel
2.8	STD	LP2987AIM-2.8	2987AIM2.8	Shipped in Anti-Static Rails
<b>8-Lead LLP</b>				
5	A	LP2987AILD-5	L009A	1000 Units on Tape and Reel
5	A	LP2987AILD-5	L009A	4500 Units on Tape and Reel
5	STD	LP2987ILD-5	L009AB	1000 Units on Tape and Reel
5	STD	LP2987ILD-5	L009AB	4500 Units on Tape and Reel
3.3	A	LP2987AILD-3.3	L008A	1000 Units on Tape and Reel
3.3	A	LP2987AILD-3.3	L008A	4500 Units on Tape and Reel
3.3	STD	LP2987ILD-3.3	L008AB	1000 Units on Tape and Reel
3.3	STD	LP2987ILD-3.3	L008AB	4500 Units on Tape and Reel
3.0	A	LP2987AILD-3.0	L007A	1000 Units on Tape and Reel
3.0	A	LP2987AILD-3.0	L007A	4500 Units on Tape and Reel
3.0	STD	LP2987ILD-3.0	L007AB	1000 Units on Tape and Reel
3.0	STD	LP2987ILD-3.0	L007AB	4500 Units on Tape and Reel

## Connection Diagram (LP2988)

### Surface Mount Packages:

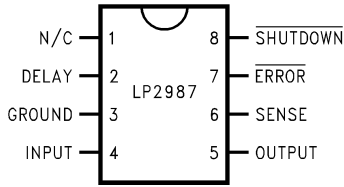

Top View

SO-8/Mini SO-8 Package

See NS Package Drawing Number M08A/MUA08A

For ordering information, refer to Table 1 in this document.

10001703

### 8-Lead LLP Surface Mount Package

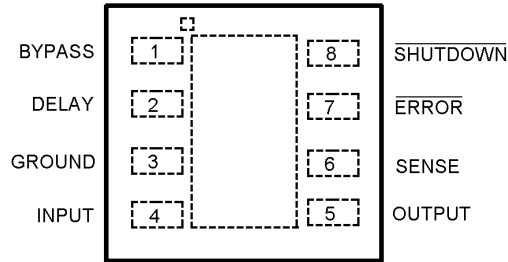

Top View

See NS Package Drawing Number LDC08A

10001758

## Ordering Information (LP2988)

TABLE 2. Package Marking and Ordering Information

Output Voltage	Grade	Order Information	Package Marking	Supplied as:
5.7	A	LP2988AIMMX-5.7	LF2A	3500 Units on Tape and Reel
5.7	A	LP2988AIMM-5.7	LF2A	1000 Units on Tape and Reel
5.7	STD	LP2988IMMX-5.7	LF2B	3500 Units on Tape and Reel
5.7	STD	LP2988IMM-5.7	LF2B	1000 Units on Tape and Reel
5.0	A	LP2988AIMMX-5.0	L51A	3500 Units on Tape and Reel
5.0	A	LP2988AIMM-5.0	L51A	1000 Units on Tape and Reel
5.0	STD	LP2988IMMX-5.0	L51B	3500 Units on Tape and Reel
5.0	STD	LP2988IMM-5.0	L51B	1000 Units on Tape and Reel
3.8	A	LP2988AIMMX-3.8	L0AA	3500 Units on Tape and Reel
3.8	A	LP2988AIMM-3.8	L0AA	1000 Units on Tape and Reel
3.8	STD	LP2988IMMX-3.8	L0AB	3500 Units on Tape and Reel
3.8	STD	LP2988IMM-3.8	L0AB	1000 Units on Tape and Reel
3.3	A	LP2988AIMMX-3.3	L50A	3500 Units on Tape and Reel
3.3	A	LP2988AIMM-3.3	L50A	1000 Units on Tape and Reel
3.3	STD	LP2988IMMX-3.3	L50B	3500 Units on Tape and Reel
3.3	STD	LP2988IMM-3.3	L50B	1000 Units on Tape and Reel
3.2	A	LP2988AIMMX-3.2	L67A	3500 Units on Tape and Reel
3.2	A	LP2988AIMM-3.2	L67A	1000 Units on Tape and Reel

**Ordering Information (LP2988)** (Continued)**TABLE 2. Package Marking and Ordering Information** (Continued)

Output Voltage	Grade	Order Information	Package Marking	Supplied as:
3.2	STD	LP2988IMMX-3.2	L67B	3500 Units on Tape and Reel
3.2	STD	LP2988IMM-3.2	L67B	1000 Units on Tape and Reel
3.0	A	LP2988AIMMX-3.0	L49A	3500 Units on Tape and Reel
3.0	A	LP2988AIMM-3.0	L49A	1000 Units on Tape and Reel
3.0	STD	LP2988IMMX-3.0	L49B	3500 Units on Tape and Reel
3.0	STD	LP2988IMM-3.0	L49B	1000 Units on Tape and Reel
2.8	A	LP2988AIMMX-2.8	L0IA	3500 Units on Tape and Reel
2.8	A	LP2988AIMM-2.8	L0IA	1000 Units on Tape and Reel
2.8	STD	LP2988IMMX-2.8	L0IB	3500 Units on Tape and Reel
2.8	STD	LP2988IMM-2.8	L0IB	1000 Units on Tape and Reel
2.7	A	LP2988AIMMX-2.7	LCVA	3500 Units on Tape and Reel
2.7	A	LP2988AIMM-2.7	LCVA	1000 Units on Tape and Reel
2.7	STD	LP2988IMMX-2.7	LCVB	3500 Units on Tape and Reel
2.7	STD	LP2988IMM-2.7	LCVB	1000 Units on Tape and Reel
2.5	A	LP2988AIMMX-2.5	L99A	3500 Units on Tape and Reel
2.5	A	LP2988AIMM-2.5	L99A	1000 Units on Tape and Reel
2.5	STD	LP2988IMMX-2.5	L99B	3500 Units on Tape and Reel
2.5	STD	LP2988IMM-2.5	L99B	1000 Units on Tape and Reel
5.0	A	LP2988AIMX-5.0	2988AIM5.0	2500 Units on Tape and Reel
5.0	A	LP2988AIM-5.0	2988AIM5.0	Shipped in Anti-Static Rails
5.0	STD	LP2988IMX-5.0	2988IM5.0	2500 Units on Tape and Reel
5.0	STD	LP2988IM-5.0	2988IM5.0	Shipped in Anti-Static Rails
3.8	A	LP2988AIMX-3.8	2988AIM3.8	2500 Units on Tape and Reel
3.8	A	LP2988AIM-3.8	2988AIM3.8	Shipped in Anti-Static Rails
3.8	STD	LP2988IMX-3.8	2988IM3.8	2500 Units on Tape and Reel

**Ordering Information (LP2988)** (Continued)**TABLE 2. Package Marking and Ordering Information** (Continued)

Output Voltage	Grade	Order Information	Package Marking	Supplied as:
3.8	STD	LP2988IM-3.8	2988IM3.8	Shipped in Anti-Static Rails
3.3	A	LP2988AIMX-3.3	2988AIM3.3	2500 Units on Tape and Reel
3.3	A	LP2988AIM-3.3	2988AIM3.3	Shipped in Anti-Static Rails
3.3	STD	LP2988IMX-3.3	2988IM3.3	2.5k Units on Tape and Reel
3.3	STD	LP2988IM-3.3	2988IM3.3	Shipped in Anti-Static Rails
3.2	A	LP2988AIMX-3.2	2988AIM3.2	2500 Units on Tape and Reel
3.2	A	LP2988AIM-3.2	2988AIM3.2	Shipped in Anti-Static Rails
3.2	STD	LP2988IMX-3.2	2988IM3.2	2500 Units on Tape and Reel
3.2	STD	LP2988IM-3.2	2988IM3.2	Shipped in Anti-Static Rails
3.0	A	LP2988AIMX-3.0	2988AIM3.0	2500 Units on Tape and Reel
3.0	A	LP2988AIM-3.0	2988AIM3.0	Shipped in Anti-Static Rails
3.0	STD	LP2988IMX-3.0	2988IM3.0	2500 Units on Tape and Reel
3.0	STD	LP2988IM-3.0	2988IM3.0	Shipped in Anti-Static Rails
2.8	A	LP2988AIMX-2.8	2988AIM2.8	2500 Units on Tape and Reel
2.8	A	LP2988AIM-2.8	2988AIM2.8	Shipped in Anti-Static Rails
2.8	STD	LP2988IMX-2.8	2988IM2.8	2500 Units on Tape and Reel
2.8	STD	LP2988IM-2.8	2988IM2.8	Shipped in Anti-Static Rails
2.7	A	LP2988AIMX-2.7	2988AIM2.7	2500 Units on Tape and Reel
2.7	A	LP2988AIM-2.7	2988AIM2.7	Shipped in Anti-Static Rails
2.7	STD	LP2988IMX-2.7	2988IM2.7	2500 Units on Tape and Reel
2.7	STD	LP2988IM-2.7	2988IM2.7	Shipped in Anti-Static Rails
2.5	A	LP2988AIMX-2.5	2988AIM2.5	2500 Units on Tape and Reel
2.5	A	LP2988AIM-2.5	2988AIM2.5	Shipped in Anti-Static Rails
2.5	STD	LP2988IMX-2.5	2988IM2.5	2500 Units on Tape and Reel
2.5	STD	LP2988IM-2.5	2988IM2.5	Shipped in Anti-Static Rails

**Ordering Information (LP2988)** (Continued)**TABLE 2. Package Marking and Ordering Information** (Continued)

Output Voltage	Grade	Order Information	Package Marking	Supplied as:
<b>8-Lead LLP</b>				
5	A	LP2988AILD-5	L01DA	1000 Units on Tape and Reel
5	A	LP2988AILD-5	L01DA	4500 Units on Tape and Reel
5	STD	LP2988ILD-5	L01DAB	1000 Units on Tape and Reel
5	STD	LP2988ILD-5	L01DAB	4500 Units on Tape and Reel
3.3	A	LP2988AILD-3.3	L01CA	1000 Units on Tape and Reel
3.3	A	LP2988AILD-3.3	L01CA	4500 Units on Tape and Reel
3.3	STD	LP2988ILD-3.3	L01CAB	1000 Units on Tape and Reel
3.3	STD	LP2988ILD-3.3	L01CAB	4500 Units on Tape and Reel
3.0	A	LP2988AILD-3.0	L01BA	1000 Units on Tape and Reel
3.0	A	LP2988AILD-3.0	L01BA	4500 Units on Tape and Reel
3.0	STD	LP2988ILD-3.0	L01BAB	1000 Units on Tape and Reel
3.0	STD	LP2988ILD-3.0	L01BAB	4500 Units on Tape and Reel
2.5	A	LP2988AILD-2.5	L01AA	1000 Units on Tape and Reel
2.5	A	LP2988AILD-2.5	L01AA	4500 Units on Tape and Reel
2.5	STD	LP2988ILD-2.5	L01AAB	1000 Units on Tape and Reel
2.5	STD	LP2988ILD-2.5	L01AAB	4500 Units on Tape and Reel



### Absolute Maximum Ratings (Note 1)

If Military/Aerospace specified devices are required, please contact the National Semiconductor Sales Office/Distributors for availability and specifications.

Storage Temperature Range	-65°C to +150°C
Operating Junction Temperature Range	-40°C to +125°C
Lead Temperature (Soldering, 5 seconds)	260°C
ESD Rating (Note 2)	2 kV
Power Dissipation (Note 3)	Internally Limited
Input Supply Voltage (Survival)	-0.3V to +16V

Input Supply Voltage (Operating)	2.1V to +16V
Shutdown Pin	-0.3V to +16V
Sense Pin	-0.3V to +6V
Output Voltage (Survival) (Note 4)	-0.3V to +16V
I <sub>OUT</sub> (Survival)	Short Circuit Protected
Input-Output Voltage (Survival) (Note 5)	-0.3V to +16V

### Electrical Characteristics

Limits in standard typeface are for T<sub>J</sub> = 25°C, and limits in **boldface type** apply over the full operating temperature range. Unless otherwise specified: V<sub>IN</sub> = V<sub>O(NOM)</sub> + 1V, I<sub>L</sub> = 1 mA, C<sub>OUT</sub> = 4.7 µF, C<sub>IN</sub> = 2.2 µF, V<sub>S/D</sub> = 2V.

Symbol	Parameter	Conditions	Typical	LM2987/8AI-X.X (Note 6)		LM2987/8I-X.X (Note 6)		Units
				Min	Max	Min	Max	
ΔV <sub>O</sub>	Output Voltage Tolerance	0.1 mA < I <sub>L</sub> < 200 mA		-0.5	0.5	-1.0	1.0	%V <sub>NOM</sub>
				-0.8	0.8	-1.6	1.6	
				<b>-1.8</b>	<b>1.8</b>	<b>-2.8</b>	<b>2.8</b>	
$\frac{\Delta V_O}{\Delta V_{IN}}$	Output Voltage Line Regulation	V <sub>O(NOM)</sub> + 1V ≤ V <sub>IN</sub> ≤ 16V	0.007		0.014		0.014	%V
					<b>0.032</b>		<b>0.032</b>	
V <sub>IN</sub> -V <sub>O</sub>	Dropout Voltage (Note 7)	I <sub>L</sub> = 100 µA	1		2.0		2.0	mV
		I <sub>L</sub> = 75 mA	90		120		120	
		I <sub>L</sub> = 200 mA	180		230		230	
					<b>350</b>		<b>350</b>	
I <sub>GND</sub>	Ground Pin Current	I <sub>L</sub> = 100 µA	100		120		120	µA
		I <sub>L</sub> = 75 mA	500		800		800	
		I <sub>L</sub> = 200 mA	1		2.1		2.1	mA
		V <sub>S/D</sub> < 0.3V	0.05		<b>1.5</b>		<b>1.5</b>	
I <sub>O(PK)</sub>	Peak Output Current	V <sub>OUT</sub> ≥ V <sub>O(NOM)</sub> - 5%	400	250		250		mA
I <sub>O(MAX)</sub>	Short Circuit Current	R <sub>L</sub> = 0 (Steady State) (Note 10)	400					
e <sub>n</sub>	LP2987 Output Noise Voltage (RMS)	BW = 300 Hz to 50 kHz, V <sub>OUT</sub> = 3.3V, C <sub>OUT</sub> = 10 µF	100					µV(RMS)
	LP2988 Output Noise Voltage (RMS)	BW = 300 Hz to 50 kHz, V <sub>OUT</sub> = 3.3V, C <sub>OUT</sub> = 10 µF, C <sub>BYPASS</sub> = .01 µF	20					
$\frac{\Delta V_{OUT}}{\Delta V_{IN}}$	Ripple Rejection	f = 1 kHz, C <sub>OUT</sub> = 10 µF, C <sub>BYP</sub> = 0 (LP2988)	65					dB

## Electrical Characteristics (Continued)

Limits in standard typeface are for  $T_J = 25^\circ\text{C}$ , and limits in **boldface type** apply over the full operating temperature range. Unless otherwise specified:  $V_{IN} = V_O(\text{NOM}) + 1\text{V}$ ,  $I_L = 1\text{ mA}$ ,  $C_{OUT} = 4.7\ \mu\text{F}$ ,  $C_{IN} = 2.2\ \mu\text{F}$ ,  $V_{S/D} = 2\text{V}$ .

Symbol	Parameter	Conditions	Typical	LM2987/8AI-X.X (Note 6)		LM2987/8I-X.X (Note 6)		Units
				Min	Max	Min	Max	
$\frac{\Delta V_{OUT}}{\Delta T}$	Output Voltage Temperature Coefficient	(Note 9)	20					ppm/ $^\circ\text{C}$
$I_{DELAY}$	Delay Pin Current Source		2.2	1.6 <b>1.4</b>	2.8 <b>3.0</b>	1.6 <b>1.4</b>	2.8 <b>3.0</b>	$\mu\text{A}$
<b>SHUTDOWN INPUT</b>								
$V_{S/D}$	S/D Input Voltage (Note 8)	$V_H = \text{O/P ON}$	1.4	<b>1.6</b>		<b>1.6</b>		V
		$V_L = \text{O/P OFF}$	0.55		<b>0.18</b>		<b>0.18</b>	
$I_{S/D}$	S/D Input Current	$V_{S/D} = 0$	0		<b>-1</b>		<b>-1</b>	$\mu\text{A}$
		$V_{S/D} = 5\text{V}$	5		<b>15</b>		<b>15</b>	
<b>ERROR COMPARATOR</b>								
$I_{OH}$	Output "HIGH" Leakage	$V_{OH} = 16\text{V}$	0.01		1 <b>2</b>		1 <b>2</b>	$\mu\text{A}$
$V_{OL}$	Output "LOW" Voltage	$V_{IN} = V_O(\text{NOM}) - 0.5\text{V}$ , $I_O(\text{COMP}) = 300\ \mu\text{A}$	150		220 <b>350</b>		220 <b>350</b>	mV
$V_{THR}(\text{MAX})$	Upper Threshold Voltage		-4.6	-5.5 <b>-7.7</b>	-3.5 <b>-2.5</b>	-5.5 <b>-7.7</b>	-3.5 <b>-2.5</b>	% $V_{OUT}$
$V_{THR}(\text{MIN})$	Lower Threshold Voltage		-6.6	-8.9 <b>-13.0</b>	-4.9 <b>-3.3</b>	-8.9 <b>-13.0</b>	-4.9 <b>-3.3</b>	
HYST	Hysteresis		2.0					

**Note 1:** Absolute Maximum Ratings indicate limits beyond which damage to the component may occur. Electrical specifications do not apply when operating the device outside of its rated operating conditions.

**Note 2:** The ESD rating of the Bypass pin is 500V (LP2988 only).

**Note 3:** The maximum allowable power dissipation is a function of the maximum junction temperature,  $T_J(\text{MAX})$ , the junction-to-ambient thermal resistance,  $\theta_{J-A}$ , and the ambient temperature,  $T_A$ . The maximum allowable power dissipation is calculated using:

$$P(\text{MAX}) = \frac{T_J(\text{MAX}) - T_A}{\theta_{J-A}}$$

The value of  $\theta_{J-A}$  for the SO-8 (M) package is 160 $^\circ\text{C/W}$ , and the mini SO-8 (MM) package is 200 $^\circ\text{C/W}$ . The value  $\theta_{J-A}$  for the LLP (LD) package is specifically dependent on PCB trace area, trace material, and the number of layers and thermal vias. For improved thermal resistance and power dissipation for the LLP package, refer to Application Note AN-1187. Exceeding the maximum allowable power dissipation will cause excessive die temperature, and the regulator will go into thermal shutdown.

**Note 4:** If used in a dual-supply system where the regulator load is returned to a negative supply, the LM2987/8 output must be diode-clamped to ground.

**Note 5:** The output PNP structure contains a diode between the  $V_{IN}$  and  $V_{OUT}$  terminals that is normally reverse-biased. Forcing the output above the input will turn on this diode and may induce a latch-up mode which can damage the part (see Application Hints).

**Note 6:** Limits are 100% production tested at 25 $^\circ\text{C}$ . Limits over the operating temperature range are guaranteed through correlation using Statistical Quality Control (SQC) methods. The limits are used to calculate National's Average Outgoing Quality Level (AOQL).

**Note 7:** Dropout voltage is defined as the input to output differential at which the output voltage drops 100 mV below the value measured with a 1V differential.

**Note 8:** To prevent mis-operation, the Shutdown input must be driven by a signal that swings above  $V_H$  and below  $V_L$  with a slew rate not less than 40 mV/ $\mu\text{s}$  (see Application Hints).

**Note 9:** Temperature coefficient is defined as the maximum (worst-case) change divided by the total temperature range.

**Note 10:** See Typical Performance Characteristics curves.

**Typical Performance Characteristics** Unless otherwise specified:  $T_A = 25^\circ\text{C}$ ,  $C_{OUT} = 4.7\ \mu\text{F}$ ,  $C_{IN} = 2.2\ \mu\text{F}$ , S/D is tied to  $V_{IN}$ ,  $V_{IN} = V_O(\text{NOM}) + 1\text{V}$ ,  $I_L = 1\ \text{mA}$ .

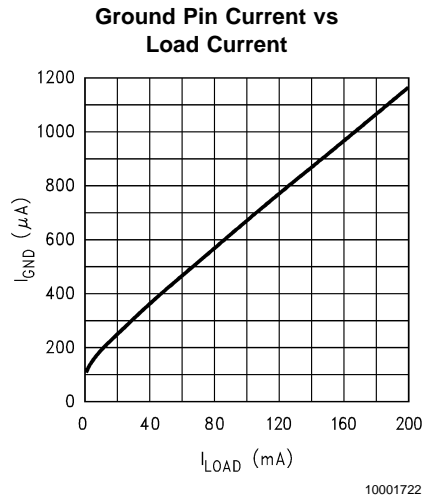
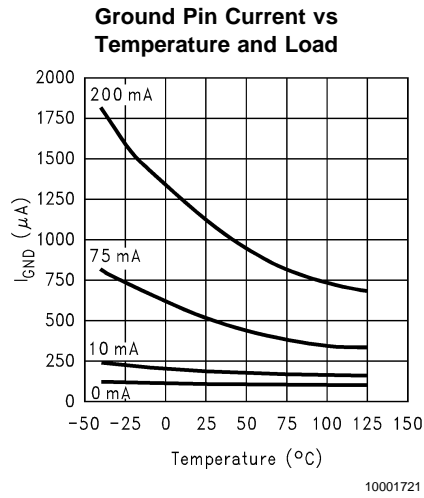
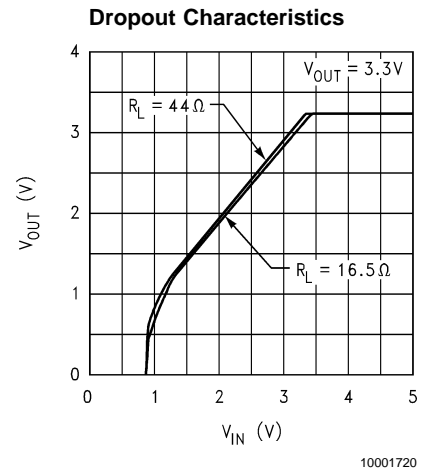
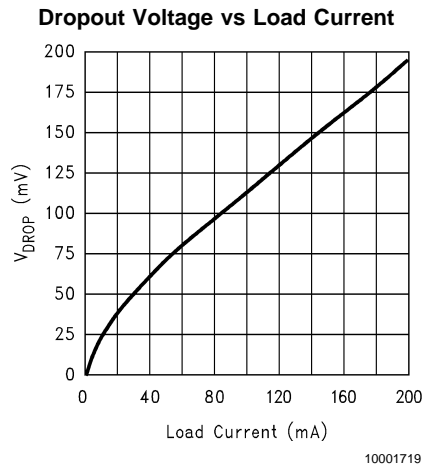
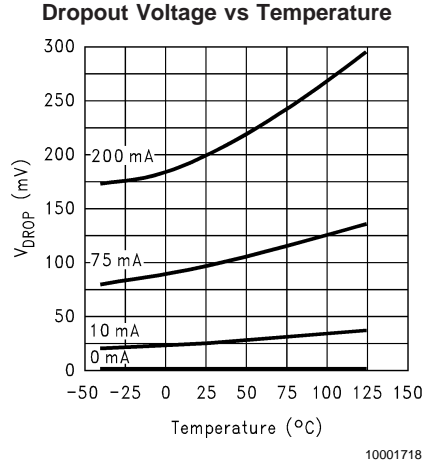
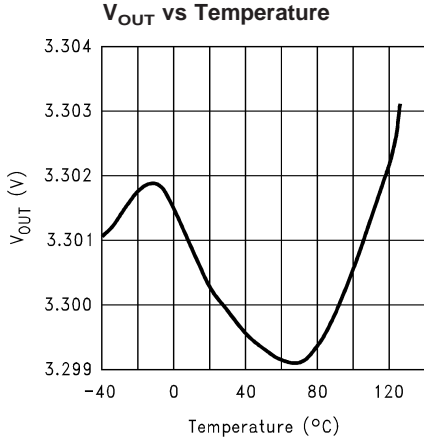

**Typical Performance Characteristics** Unless otherwise specified:  $T_A = 25^\circ\text{C}$ ,  $C_{OUT} = 4.7 \mu\text{F}$ ,  $C_{IN} = 2.2 \mu\text{F}$ , S/D is tied to  $V_{IN}$ ,  $V_{IN} = V_{O(NOM)} + 1\text{V}$ ,  $I_L = 1 \text{mA}$ . (Continued)

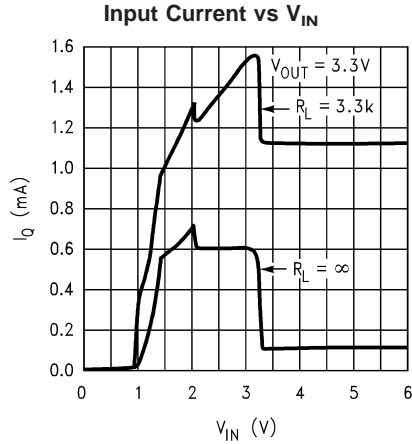

10001723

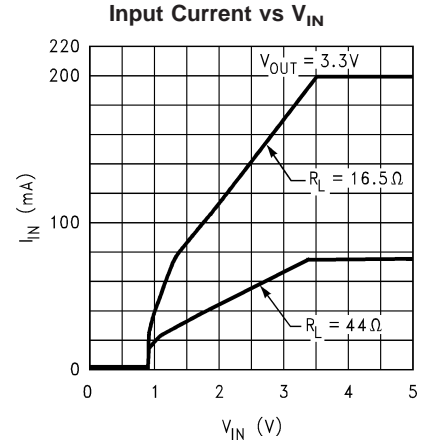

10001724

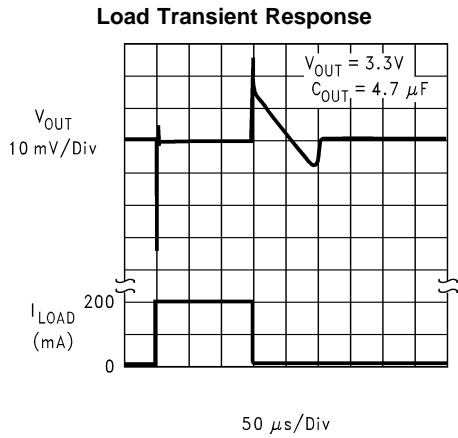

10001725

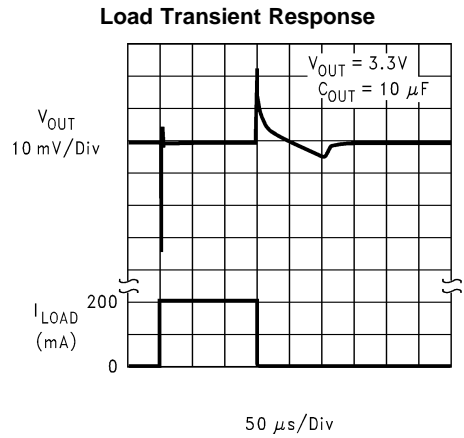

10001726

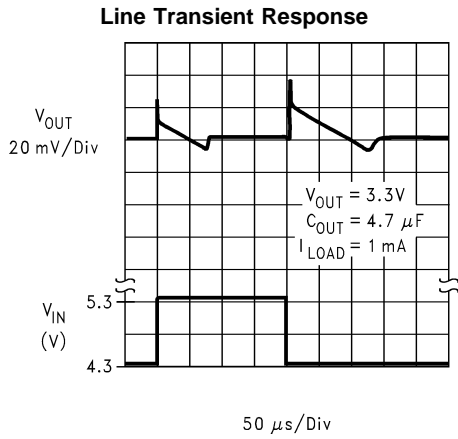

10001727

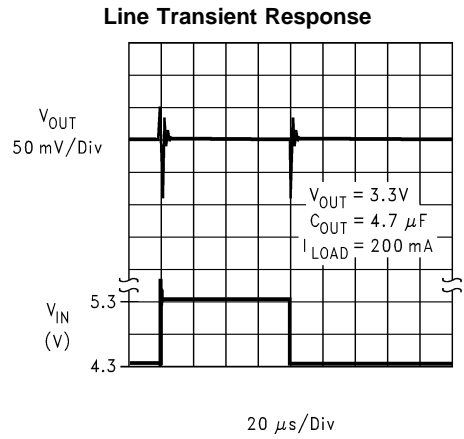

10001728

**Typical Performance Characteristics** Unless otherwise specified:  $T_A = 25^\circ\text{C}$ ,  $C_{OUT} = 4.7\ \mu\text{F}$ ,  $C_{IN} = 2.2\ \mu\text{F}$ , S/D is tied to  $V_{IN}$ ,  $V_{IN} = V_{O(NOM)} + 1\text{V}$ ,  $I_L = 1\ \text{mA}$ . (Continued)

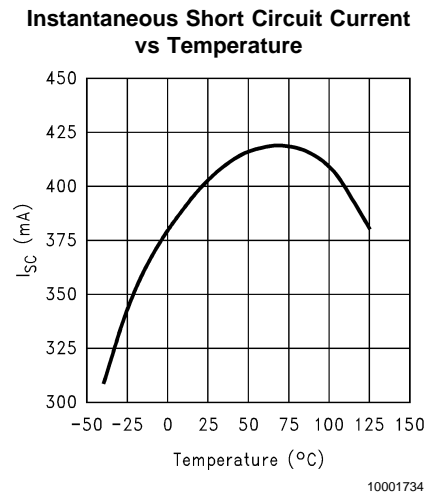
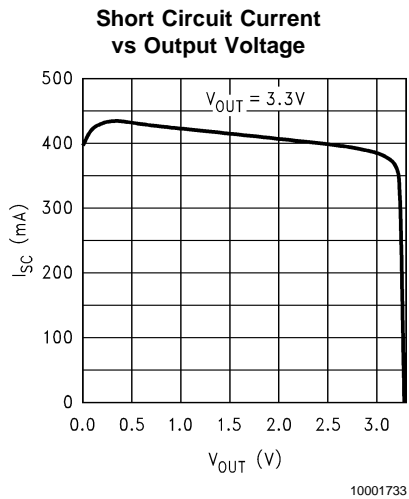
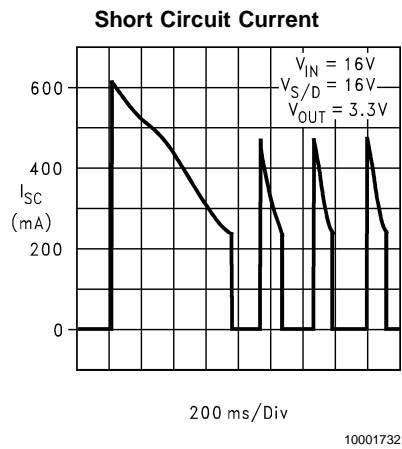
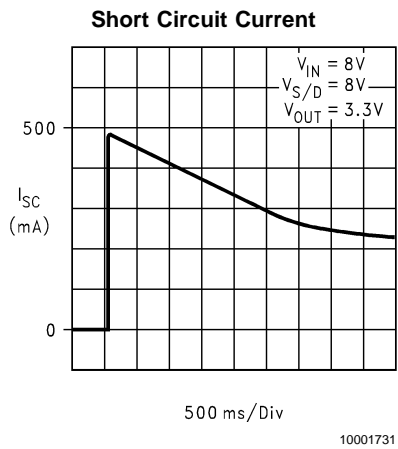
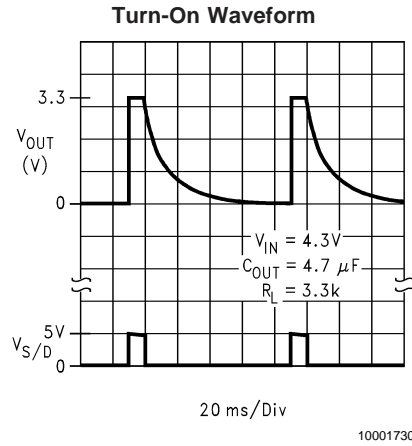
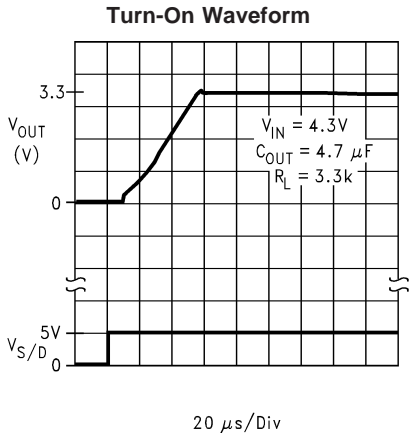

**Typical Performance Characteristics** Unless otherwise specified:  $T_A = 25^\circ\text{C}$ ,  $C_{OUT} = 4.7 \mu\text{F}$ ,  $C_{IN} = 2.2 \mu\text{F}$ , S/D is tied to  $V_{IN}$ ,  $V_{IN} = V_{O(NOM)} + 1\text{V}$ ,  $I_L = 1 \text{mA}$ . (Continued)

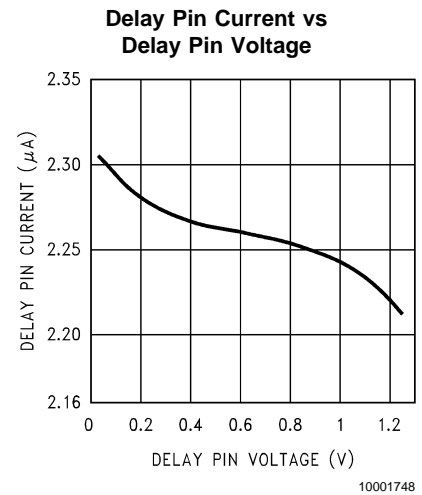
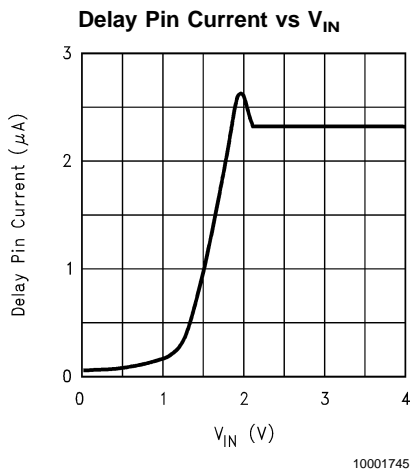
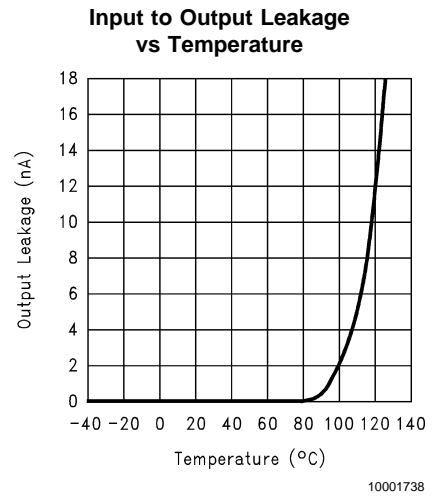
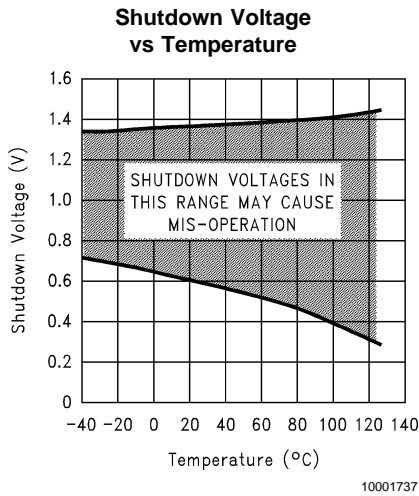
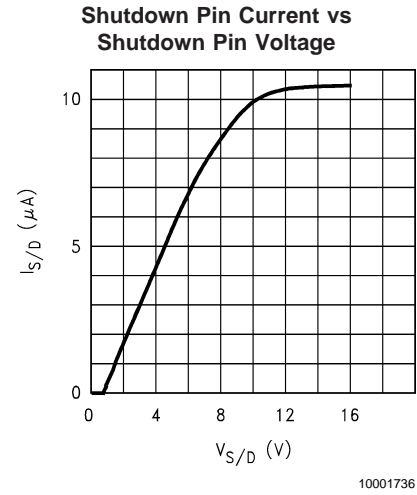
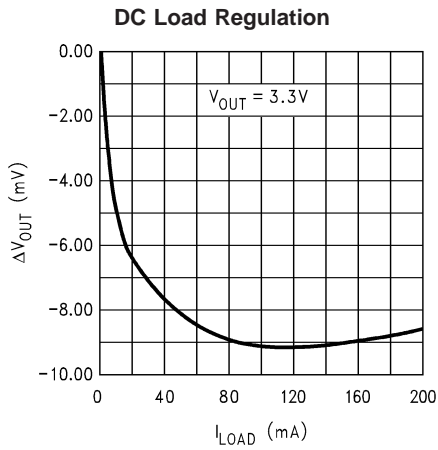

**Typical Performance Characteristics** Unless otherwise specified:  $T_A = 25^\circ\text{C}$ ,  $C_{OUT} = 4.7\ \mu\text{F}$ ,  $C_{IN} = 2.2\ \mu\text{F}$ , S/D is tied to  $V_{IN}$ ,  $V_{IN} = V_O(\text{NOM}) + 1\text{V}$ ,  $I_L = 1\ \text{mA}$ . (Continued)

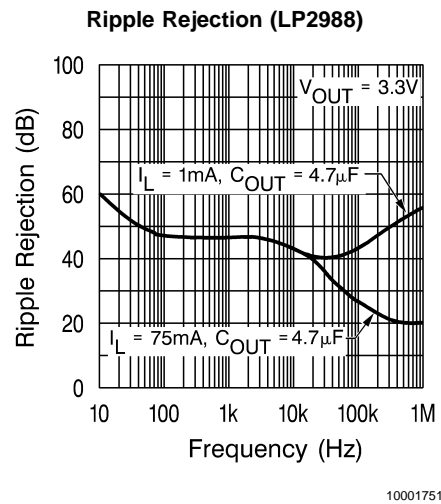
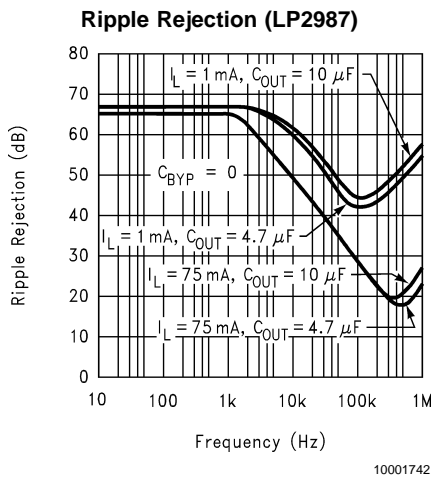
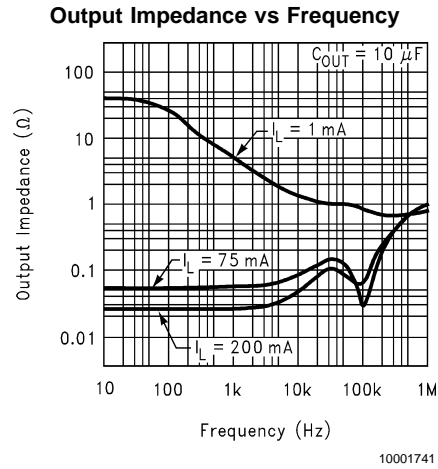
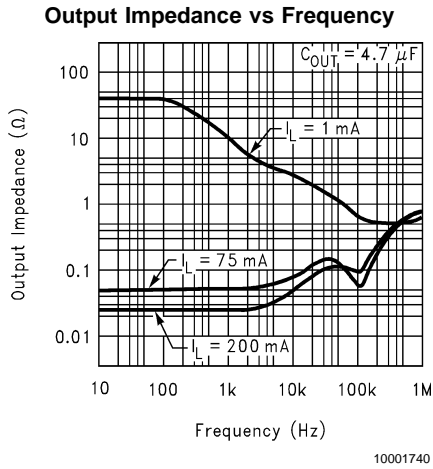
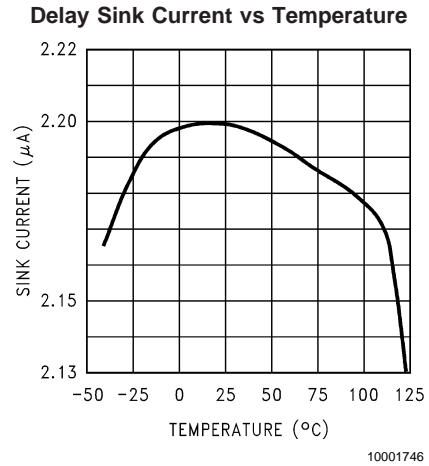
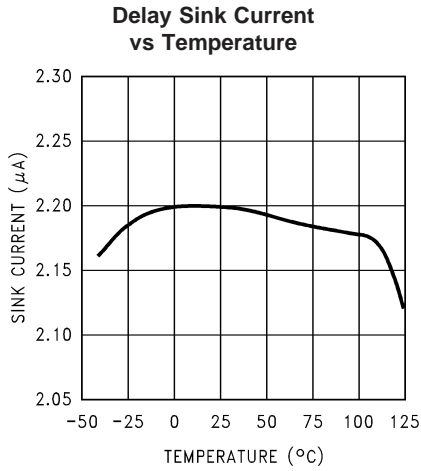

**Typical Performance Characteristics** Unless otherwise specified:  $T_A = 25^\circ\text{C}$ ,  $C_{OUT} = 4.7 \mu\text{F}$ ,  $C_{IN} = 2.2 \mu\text{F}$ , S/D is tied to  $V_{IN}$ ,  $V_{IN} = V_{O(NOM)} + 1\text{V}$ ,  $I_L = 1 \text{mA}$ . (Continued)

**Output Noise Density (LP2987)**

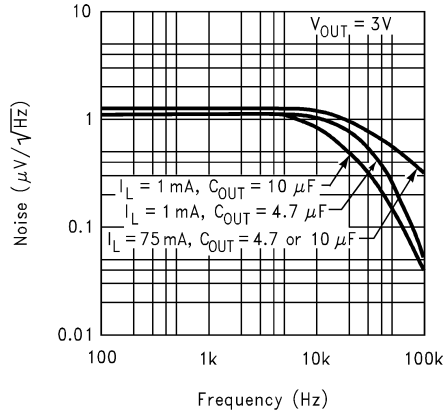

10001739

**Output Noise Voltage (LP2988)**

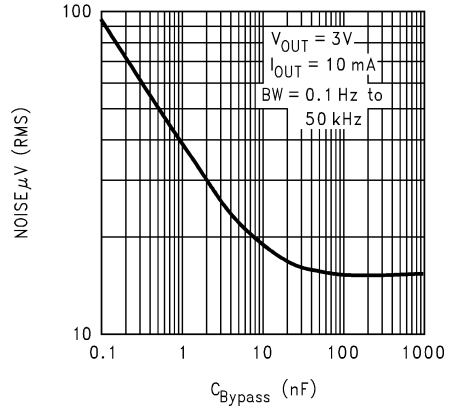

10001744

**Output Noise Density (LP2988)**

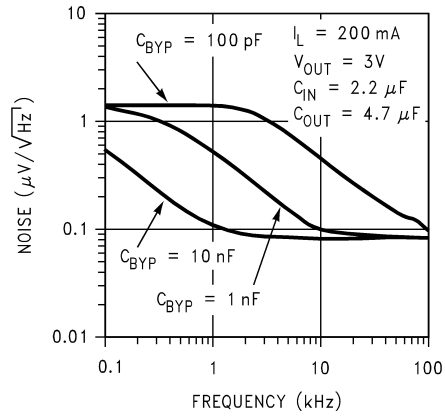

10001752

**Output Noise Density (LP2988)**

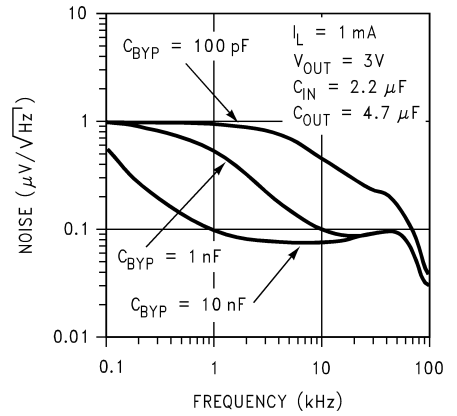

10001753

**Turn-On Time (LP2988)**

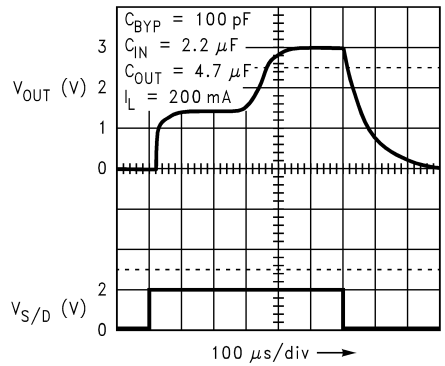

10001754

**Turn-On Time (LP2988)**

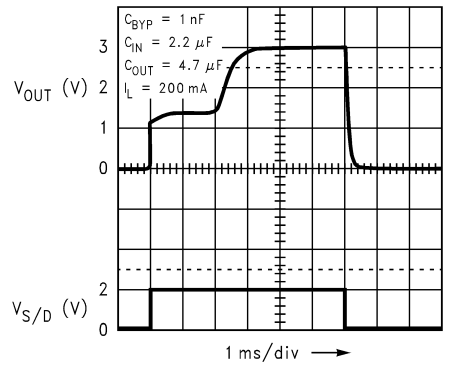

10001755



**Typical Performance Characteristics** Unless otherwise specified:  $T_A = 25^\circ\text{C}$ ,  $C_{OUT} = 4.7 \mu\text{F}$ ,  $C_{IN} = 2.2 \mu\text{F}$ ,  $S/D$  is tied to  $V_{IN}$ ,  $V_{IN} = V_O(\text{NOM}) + 1\text{V}$ ,  $I_L = 1 \text{mA}$ . (Continued)

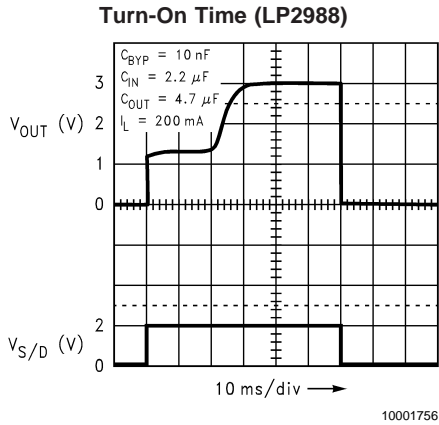

**Basic Application Circuits**

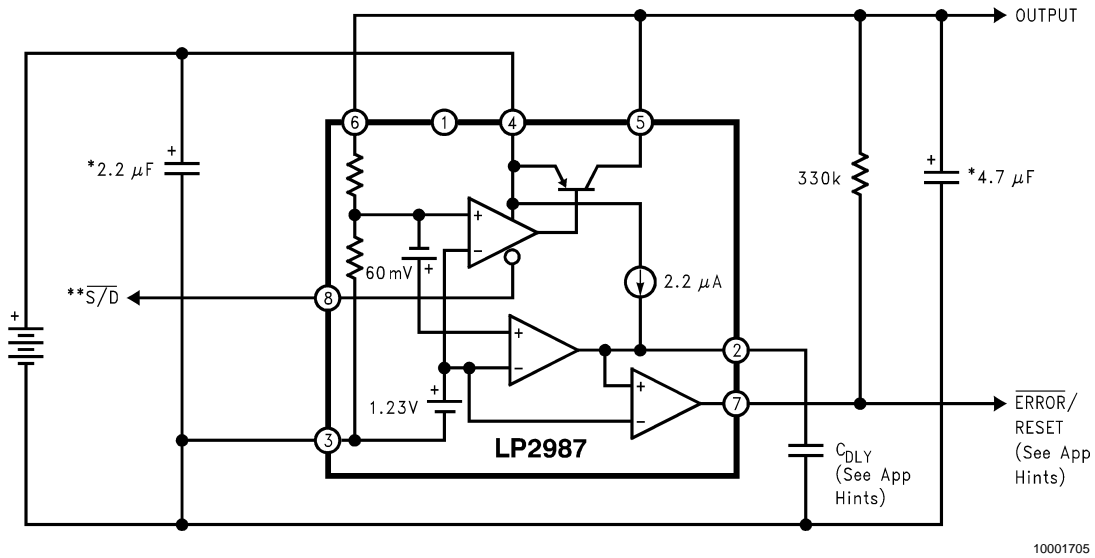

## Basic Application Circuits (Continued)

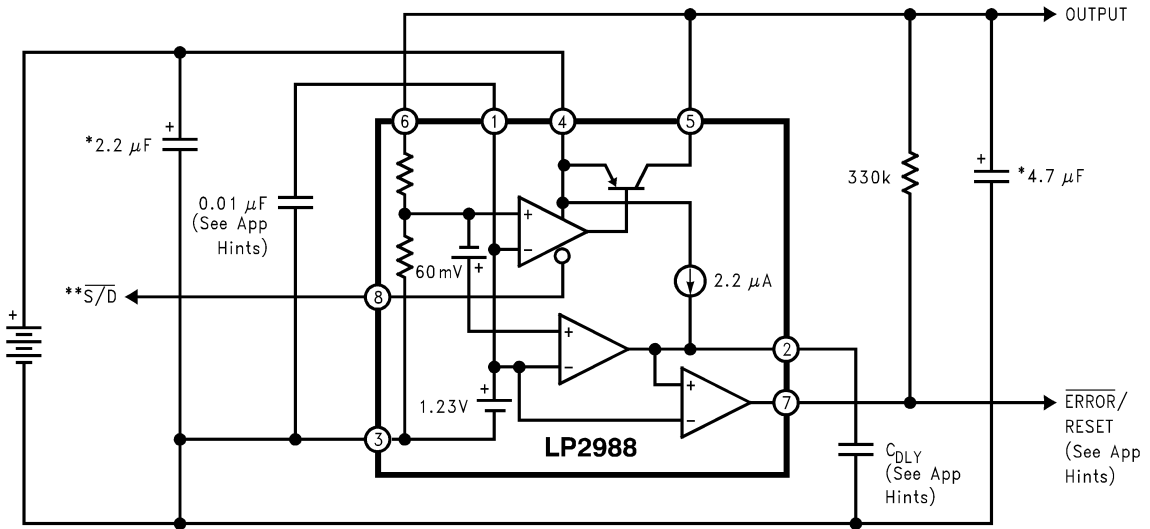

10001706

\*Capacitance value shown is minimum required to assure stability, but may be increased without limit. Larger output capacitor provides improved dynamic response.

\*\*Shutdown must be actively terminated (see Application Hints). Tie to INPUT (pin 4) if not used.

## Application Hints

### LLP Package Devices

The LP2987/LP2988 is offered in the 8 lead LLP surface mount package to allow for increased power dissipation compared to the SO-8 and Mini SO-8. For details on thermal performance as well as mounting and soldering specifications, refer to Application Note AN-1187.

### EXTERNAL CAPACITORS

As with any low-dropout regulator, external capacitors are required to assure stability. These capacitors must be correctly selected for proper performance.

**INPUT CAPACITOR:** An input capacitor ( $\geq 2.2 \mu\text{F}$ ) is required between the LP2987/8 input and ground (amount of capacitance may be increased without limit).

This capacitor must be located a distance of not more than 0.5" from the input pin and returned to a clean analog ground. Any good quality ceramic or tantalum may be used for this capacitor.

**OUTPUT CAPACITOR:** The output capacitor must meet the requirement for minimum amount of capacitance and also have an appropriate E.S.R. (equivalent series resistance) value.

Curves are provided which show the allowable ESR range as a function of load current for 3V and 5V outputs.

### ESR Curves For 5V Output

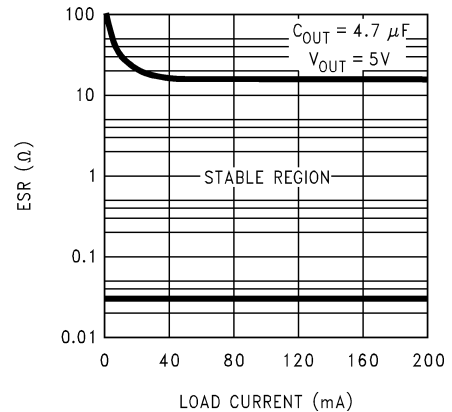

10001707

### ESR Curves For 3V Output

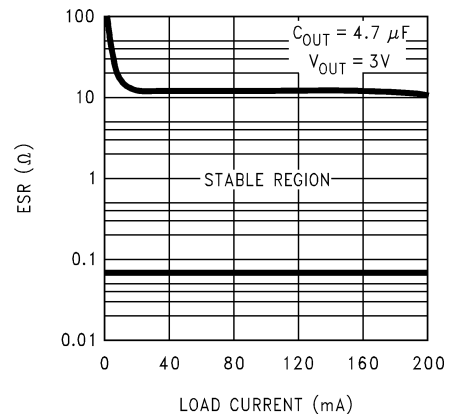

10001708

## Application Hints (Continued)

**IMPORTANT:** The output capacitor must maintain its ESR in the stable region *over the full operating temperature range of the application* to assure stability.

The minimum required amount of output capacitance is 4.7  $\mu\text{F}$ . Output capacitor size can be increased without limit.

It is important to remember that capacitor tolerance and variation with temperature must be taken into consideration when selecting an output capacitor so that the minimum required amount of output capacitance is provided over the full operating temperature range. A good Tantalum capacitor will show very little variation with temperature, but a ceramic may not be as good (see next section).

The output capacitor should be located not more than 0.5" from the output pin and returned to a clean analog ground.

### CAPACITOR CHARACTERISTICS

**TANTALUM:** A solid tantalum capacitor is the best choice for the output capacitor on the LM2987/8. Available from many sources, their typical ESR is very close to the ideal value required on the output of many LDO regulators.

Tantalums also have good temperature stability: a 4.7  $\mu\text{F}$  was tested and showed only a 10% decline in capacitance as the temperature was decreased from +125°C to -40°C. The ESR increased only about 2:1 over the same range of temperature.

However, it should be noted that the increasing ESR at lower temperatures present in all tantalums can cause oscillations when marginal quality capacitors are used (where the ESR of the capacitor is near the upper limit of the stability range at room temperature).

**CERAMIC:** The ESR of ceramic capacitor can be low enough to cause an LDO regulator to oscillate: a 2.2  $\mu\text{F}$  ceramic was measured and found to have an ESR of 15 m $\Omega$ .

If a ceramic capacitor is to be used on the LP2987/8 output, a 1 $\Omega$  resistor should be placed in series with the capacitor to provide a minimum ESR for the regulator.

A disadvantage of ceramic capacitors is that their capacitance varies a lot with temperature: Large ceramic capacitors are typically manufactured with the Z5U temperature characteristic, which results in the capacitance dropping by 50% as the temperature goes from 25°C to 80°C.

This means you have to buy a capacitor with twice the minimum  $C_{\text{OUT}}$  to assure stable operation up to 80°C.

**ALUMINUM:** The large physical size of aluminum electrolytics makes them unsuitable for most applications. Their ESR characteristics are also not well suited to the requirements of LDO regulators. The ESR of a typical aluminum electrolytic is higher than a tantalum, and it also varies greatly with temperature.

A typical aluminum electrolytic can exhibit an ESR increase of 50X when going from 20°C to -40°C. Also, some aluminum electrolytics can not be used below -25°C because the electrolyte will freeze.

### POWER-ON RESET DELAY

A power-on reset function can be easily implemented using the LP2987/8 by adding a single external capacitor to the Delay pin. The Error output provides the power-on reset signal when input power is applied to the regulator.

The reset signal stays low for a pre-set time period after power is applied to the regulator, and then goes high (see Timing Diagram below).

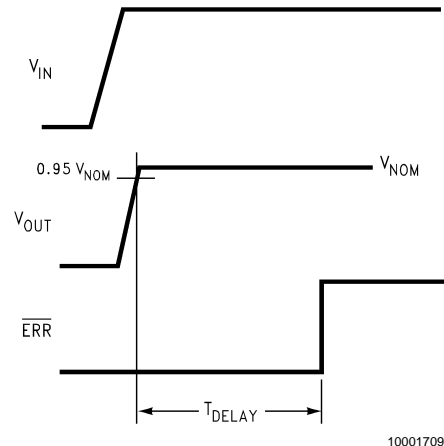

Timing Diagram for Power-Up

The external capacitor  $C_{\text{DLY}}$  sets the delay time ( $T_{\text{DELAY}}$ ). The value of capacitor required for a given time delay may be calculated using the formula:

$$C_{\text{DLY}} = T_{\text{DELAY}} / (5.59 \times 10^5)$$

To simplify design, a plot is provided below which shows values of  $C_{\text{DLY}}$  versus delay time.

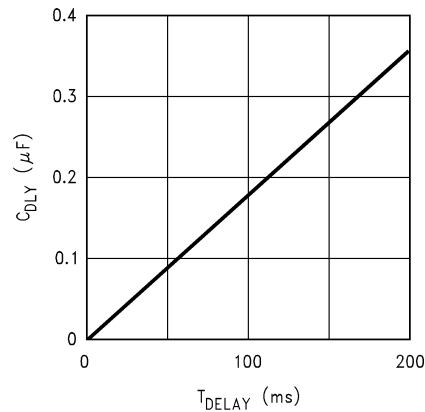

Plot of  $C_{\text{DLY}}$  vs  $T_{\text{DELAY}}$

## Application Hints (Continued)

**DETAILS OF ERR/RESET CIRCUIT OPERATION:** (Refer to LP2987/8 Equivalent Circuit).

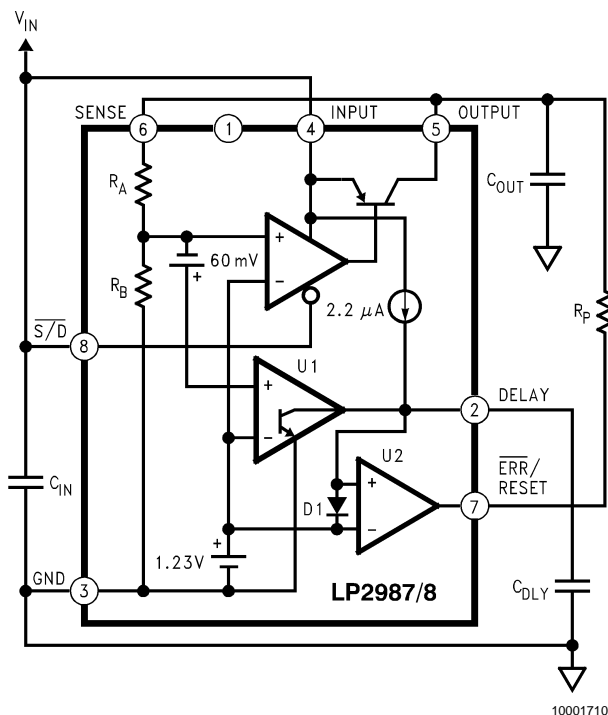

LP2987/8 Equivalent Circuit

The output of comparator U2 is the ERR/RESET flag. Since it is an open-collector output, it requires the use of a pull-up resistor ( $R_P$ ). The 1.23V reference is tied to the inverting input of U2, which means that its output is controlled by the voltage applied to the non-inverting input.

The output of U1 (also an open-collector) will force the non-inverting input of U2 to go low whenever the LP2987/8 regulated output drops about 5% below nominal.

U1's inverting input is also held at 1.23V. The other input samples the regulated output through a resistive divider ( $R_A$  and  $R_B$ ). When the regulated output is at nominal voltage, the voltage at the divider tap point will be 1.23V. If this voltage drops about 60 mV below 1.23V, the output of U1 will go low forcing the output of U2 low (which is the ERROR state).

Power-ON reset delay occurs when a capacitor (shown as  $C_{DLY}$ ) is connected to the Delay pin. At turn-ON, this capacitor is initially fully discharged (which means the voltage at the Delay pin is 0V). The output of U1 keeps  $C_{DLY}$  fully discharged (by sinking the 2.2  $\mu$ A from the current source) until the regulator output voltage comes up to within about 5% of nominal. At this point, U1's output stops sinking current and the 2.2  $\mu$ A starts charging up  $C_{DLY}$ .

When the voltage across  $C_{DLY}$  reaches 1.23V, the output of U2 will go high (note that D1 limits the maximum voltage to about 2V).

**SELECTING  $C_{DLY}$ :** The maximum recommended value for this capacitor is 1  $\mu$ F. The capacitor must not have excessively high leakage current, since it is being charged from a 2.2  $\mu$ A current source.

Aluminum electrolytics can not be used, but good-quality tantalum, ceramic, mica, or film types will work.

### SHUTDOWN INPUT OPERATION

The LP2987/8 is shut off by driving the Shutdown input low, and turned on by pulling it high. If this feature is not to be used, the Shutdown input should be tied to  $V_{IN}$  to keep the regulator output on at all times.

To assure proper operation, the signal source used to drive the Shutdown input must be able to swing above and below the specified turn-on/turn-off voltage thresholds listed as  $V_H$  and  $V_L$ , respectively (see Electrical Characteristics).

It is also important that the turn-on (and turn-off) voltage signals applied to the Shutdown input have a slew rate which is not less than 40 mV/ $\mu$ s.

**CAUTION:** the regulator output state can not be guaranteed if a slow-moving AC (or DC) signal is applied that is in the range between  $V_H$  and  $V_L$ .

### REVERSE INPUT-OUTPUT VOLTAGE

The PNP power transistor used as the pass element in the LP2987/8 has an inherent diode connected between the regulator output and input.

During normal operation (where the input voltage is higher than the output) this diode is reverse-biased.

However, if the output is pulled above the input, this diode will turn ON and current will flow into the regulator output.

In such cases, a parasitic SCR can latch which will allow a high current to flow into  $V_{IN}$  (and out the ground pin), which can damage the part.

In any application where the output may be pulled above the input, an external Schottky diode must be connected from  $V_{IN}$  to  $V_{OUT}$  (cathode on  $V_{IN}$ , anode on  $V_{OUT}$ ), to limit the reverse voltage across the LP2987/8 to 0.3V (see Absolute Maximum Ratings).

### BYPASS CAPACITOR (LP2988)

The capacitor connected to the Bypass pin must have very low leakage. The current flowing out of the Bypass pin comes from the Bandgap reference, which is used to set the output voltage. Since the Bandgap circuit has only a few microamps flowing in it, loading effects due to leakage current will cause a change in the regulated output voltage.

Curves are provided which show the effect of loading the Bypass pin on the regulated output voltage.

Care must be taken to ensure that the capacitor selected for bypass will not have significant leakage current over the operating temperature range of the application.

A high quality ceramic capacitor which uses either NPO or COG type dielectric material will typically have very low leakage. Small surface-mount polypropylene or polycarbonate film capacitors also have extremely low leakage, but are slightly larger in size than ceramics.

**Application Hints** (Continued)

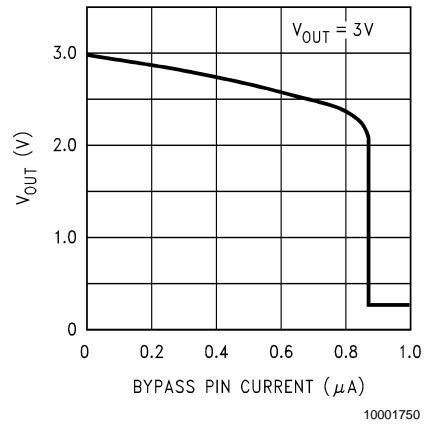
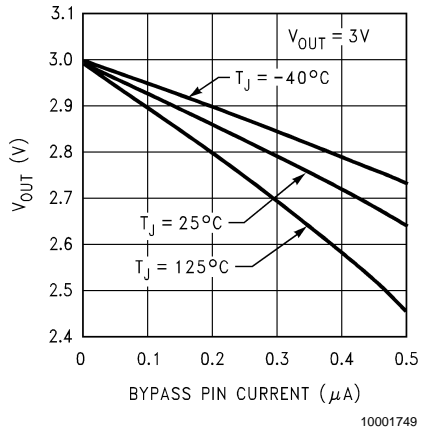



**Physical Dimensions** inches (millimeters) unless otherwise noted (Continued)

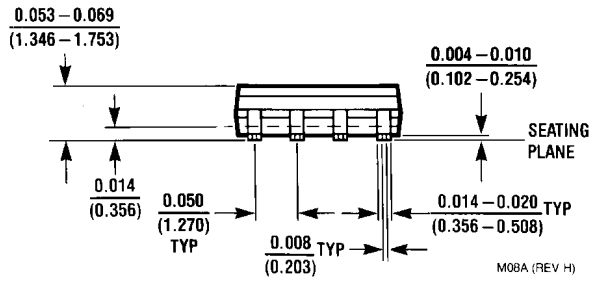
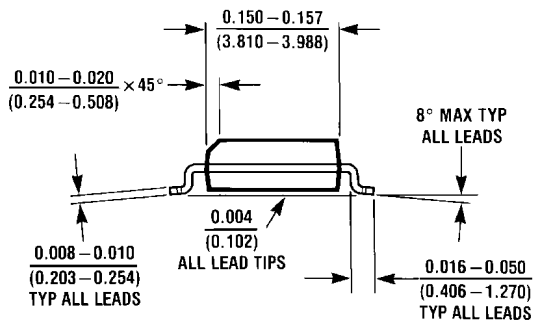
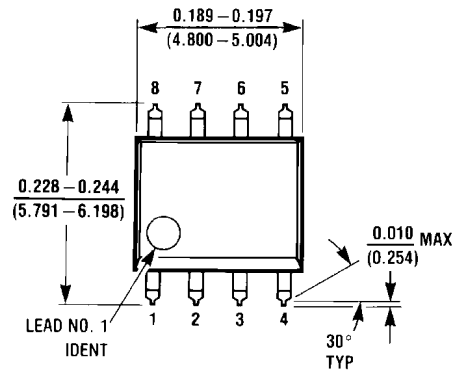

**SO-8 Package Type M  
NS Package Number M08A**

M08A (REV H)

**Physical Dimensions** inches (millimeters) unless otherwise noted (Continued)

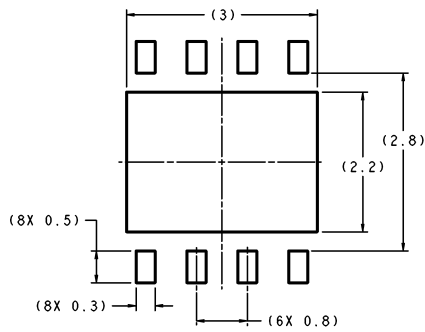

RECOMMENDED LAND PATTERN  
1:1 RATION WITH PKG SOLDER PADS

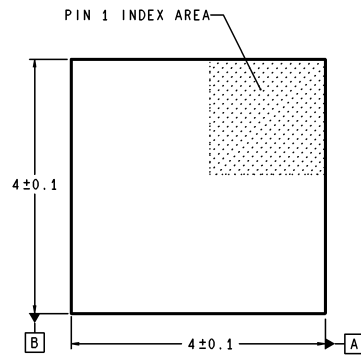

DIMENSIONS ARE IN MILLIMETERS

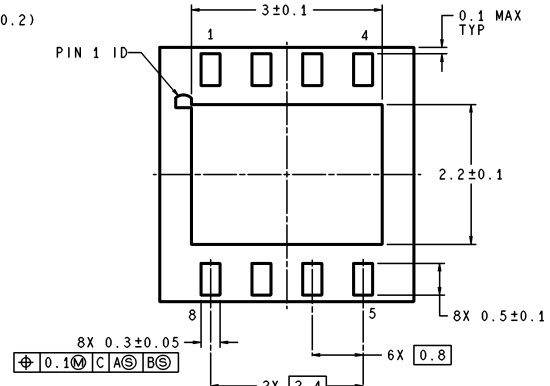
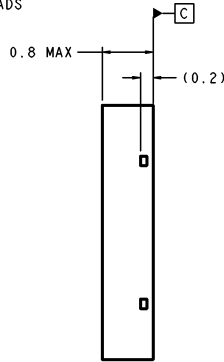

LDC08A (Rev A)

**8-Lead LLP Surface Mount Package  
NS Package Number LDC08A**

**LIFE SUPPORT POLICY**

NATIONAL'S PRODUCTS ARE NOT AUTHORIZED FOR USE AS CRITICAL COMPONENTS IN LIFE SUPPORT DEVICES OR SYSTEMS WITHOUT THE EXPRESS WRITTEN APPROVAL OF THE PRESIDENT AND GENERAL COUNSEL OF NATIONAL SEMICONDUCTOR CORPORATION. As used herein:

1. Life support devices or systems are devices or systems which, (a) are intended for surgical implant into the body, or (b) support or sustain life, and whose failure to perform when properly used in accordance with instructions for use provided in the labeling, can be reasonably expected to result in a significant injury to the user.
2. A critical component is any component of a life support device or system whose failure to perform can be reasonably expected to cause the failure of the life support device or system, or to affect its safety or effectiveness.



**National Semiconductor Corporation**  
Americas  
Email: support@nsc.com

www.national.com

**National Semiconductor Europe**  
Fax: +49 (0) 180-530 85 86  
Email: europe.support@nsc.com  
Deutsch Tel: +49 (0) 69 9508 6208  
English Tel: +44 (0) 870 24 0 2171  
Français Tel: +33 (0) 1 41 91 8790

**National Semiconductor Asia Pacific Customer Response Group**  
Tel: 65-2544466  
Fax: 65-2504466  
Email: ap.support@nsc.com

**National Semiconductor Japan Ltd.**  
Tel: 81-3-5639-7560  
Fax: 81-3-5639-7507