

**Ultra-Low Noise, Low Power, Wideband Amplifier**



The EL2125 is an ultra-low noise, wideband amplifier that runs on half the supply current of competitive parts.

It is intended for use in systems such as ultrasound imaging where a very small signal needs to be amplified by a large amount without adding significant noise. Its low power dissipation enables it to be packaged in the tiny SOT-23 package, which further helps systems where many input channels create both space and power dissipation problems.

The EL2125 is stable for gains of 10 and greater and uses traditional voltage feedback. This allows the use of reactive elements in the feedback loop, a common requirement for many filter topologies. It operates from ±2.5V to ±15V supplies and is available in the 5-pin SOT-23 and 8-pin SO packages.

The EL2125 is fabricated using Elantec's proprietary complementary bipolar process, and is specified for operation from -45°C to +85°C.

**Features**

- Voltage noise of only 0.83nV/√Hz
- Current noise of only 2.4pA/√Hz
- 200µV offset voltage
- 175MHz -3dB BW for A<sub>V</sub> = 10
- Low supply current - 10mA
- SOT-23 package available
- ±2.5V to ±15V operation

**Applications**

- Ultrasound input amplifiers
- Wideband instrumentation
- Communication equipment
- AGC & PLL active filters
- Wideband sensors

**Ordering Information**

PART NUMBER	PACKAGE	TAPE & REEL	PKG. DWG. #
EL2125CW-T7	5-Pin SOT-23	7"	MDP0038
EL2125CS	8-Pin SO	-	MDP0027
EL2125CS-T7	8-Pin SO	7"	MDP0027
EL2125CS-T13	8-Pin SO	13"	MDP0027

**Pinouts**

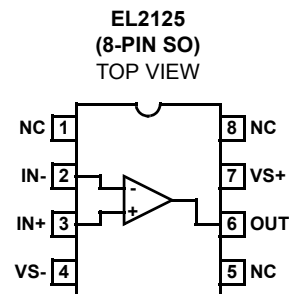
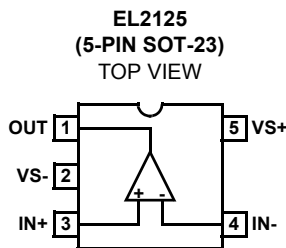

**Absolute Maximum Ratings** ( $T_A = 25^\circ\text{C}$ )

$V_{S+}$ to $V_{S-}$ .....	33V	Ambient Operating Temperature .....	-45°C to +85°C
Continuous Output Current .....	40mA	Storage Temperature .....	-65°C to +150°C
Any Input .....	$V_{S-} - 0.3\text{V}$ to $V_{S+} + 0.3\text{V}$	Maximum Die Junction Temperature .....	+150°C
Power Dissipation .....	See Curves		

CAUTION: Stresses above those listed in "Absolute Maximum Ratings" may cause permanent damage to the device. This is a stress only rating and operation of the device at these or any other conditions above those indicated in the operational sections of this specification is not implied.

IMPORTANT NOTE: All parameters having Min/Max specifications are guaranteed. Typical values are for information purposes only. Unless otherwise noted, all tests are at the specified temperature and are pulsed tests, therefore:  $T_J = T_C = T_A$

**Electrical Specifications**  $V_S = \pm 5\text{V}$ ,  $T_A = 25^\circ\text{C}$ ,  $R_F = 180\Omega$ ,  $R_G = 20\Omega$ ,  $R_L = 500\Omega$  unless otherwise specified.

PARAMETER	DESCRIPTION	CONDITIONS	MIN	TYP	MAX	UNIT
<b>DC PERFORMANCE</b>						
$V_{OS}$	Input Offset Voltage (SO8)			0.2	2	mV
	Input Offset Voltage (SOT23-5)				3	mV
$T_{CVOS}$	Offset Voltage Temperature Coefficient			1.8		$\mu\text{V}/^\circ\text{C}$
$I_B$	Input Bias Current		-30	-22		$\mu\text{A}$
$I_{OS}$	Input Bias Current Offset			0.4	2	$\mu\text{A}$
$T_{CIB}$	Input Bias Current Temperature Coefficient			0.09		$\mu\text{A}/^\circ\text{C}$
$C_{IN}$	Input Capacitance			2.2		pF
$A_{VOL}$	Open Loop Gain		80	87		dB
PSRR	Power Supply Rejection Ratio (Note 1)		80	97		dB
CMRR	Common Mode Rejection Ratio	at CMIR	80	106		dB
CMIR	Common Mode Input Range		-4.6		3.8	V
$V_{OUTH}$	Output Voltage Swing High	No load, $R_F = 1\text{k}\Omega$	3.5	3.65		V
$V_{OUTL}$	Output Voltage Swing Low	No load, $R_F = 1\text{k}\Omega$		-3.87	-3.7	V
$V_{OUTH2}$	Output Voltage Swing High	$R_L = 100\Omega$	3	3.3		V
$V_{OUTL2}$	Output Voltage Swing Low	$R_L = 100\Omega$		-3.5	-3	V
$I_{OUT}$	Output Short Circuit Current (Note 2)		80	100		mA
$I_S$	Supply Current			10.1	11	mA
<b>AC PERFORMANCE - <math>R_G = 20\Omega</math>, <math>C_L = 5\text{pF}</math></b>						
BW	-3dB Bandwidth			175		MHz
BW $\pm 0.1\text{dB}$	$\pm 0.1\text{dB}$ Bandwidth			34		MHz
BW $\pm 1\text{dB}$	$\pm 1\text{dB}$ Bandwidth			150		MHz
Peaking	Peaking			0.4		dB
SR	Slew Rate	$V_{OUT} = 2V_{P-P}$ , measured at 20% to 80%	150	185		$\text{V}/\mu\text{s}$
OS	Overshoot, $4V_{P-P}$ Output Square Wave	Positive		0.6		%
		Negative		2.7		%
$t_S$	Settling Time to 0.1% of $\pm 1\text{V}$ Pulse			42		ns
$V_N$	Voltage Noise Spectral Density	10kHz		0.83		$\text{nV}/\sqrt{\text{Hz}}$

**Electrical Specifications**  $V_S = \pm 5V$ ,  $T_A = 25^\circ C$ ,  $R_F = 180\Omega$ ,  $R_G = 20\Omega$ ,  $R_L = 500\Omega$  unless otherwise specified. (Continued)

PARAMETER	DESCRIPTION	CONDITIONS	MIN	TYP	MAX	UNIT
$I_N$	Current Noise Spectral Density	10kHz		2.4		$\mu A/\sqrt{Hz}$
HD2	2nd Harmonic Distortion (Note 3)			-74		dBc
HD3	3rd Harmonic Distortion			-91		dBc

NOTES:

1. Measured by moving the supplies from  $\pm 4V$  to  $\pm 6V$
2. Pulse test only
3. Frequency = 1MHz,  $V_{OUT} = 2V_{P-P}$ , into  $500\Omega$  and 5pF load

**Electrical Specifications**  $V_S = \pm 15V$ ,  $T_A = 25^\circ C$ ,  $R_F = 180\Omega$ ,  $R_G = 20\Omega$ ,  $R_L = 500\Omega$  unless otherwise specified.

PARAMETER	DESCRIPTION	CONDITIONS	MIN	TYP	MAX	UNIT
<b>DC PERFORMANCE</b>						
$V_{OS}$	Input Offset Voltage (SO8)			0.6	3	mV
	Input Offset Voltage (SOT23-5)				3	mV
$T_{CVOS}$	Offset Voltage Temperature Coefficient			4.9		$\mu V/^\circ C$
$I_B$	Input Bias Current		-30	-24		$\mu A$
$I_{OS}$	Input Bias Current Offset			0.4	2	$\mu A$
$T_{CIB}$	Input Bias Current Temperature Coefficient			0.08		$\mu A/^\circ C$
$C_{IN}$	Input Capacitance			2.2		pF
$A_{VOL}$	Open Loop Gain		80	87		dB
PSRR	Power Supply Rejection Ratio (Note 1)		80	97		dB
CMRR	Common Mode Rejection Ratio	at CMIR	75	105		dB
CMIR	Common Mode Input Range		-14.6		13.8	V
$V_{OUTH}$	Output Voltage Swing High	No load, $R_F = 1k\Omega$	13.35	13.5		V
$V_{OUTL}$	Output Voltage Swing Low	No load, $R_F = 1k\Omega$		-13.6	-13	V
$V_{OUTH2}$	Output Voltage Swing High	$R_L = 100\Omega$	11	11.6		V
$V_{OUTL2}$	Output Voltage Swing Low	$R_L = 100\Omega$		-10.4	-9.8	V
$I_{OUT}$	Output Short Circuit Current (Note 2)		120	250		mA
$I_S$	Supply Current			10.8	12	mA
<b>AC PERFORMANCE - <math>R_G = 20\Omega</math>, <math>C_L = 5pF</math></b>						
BW	-3dB Bandwidth			220		MHz
BW $\pm 0.1dB$	$\pm 0.1dB$ Bandwidth			23		MHz
BW $\pm 1dB$	$\pm 1dB$ Bandwidth			63		MHz
Peaking	Peaking			2.5		dB
SR	Slew Rate	$V_{OUT} = 2V_{P-P}$ , measured at 20% to 80%	180	225		$V/\mu s$
OS	Overshoot, $4V_{P-P}$ Output Square Wave			0.6		%
$t_S$	Settling Time to 0.1% of $\pm 1V$ Pulse			38		ns
$V_N$	Voltage Noise Spectral Density	10kHz		0.95		$nV/\sqrt{Hz}$

**Electrical Specifications**  $V_S = \pm 15V$ ,  $T_A = 25^\circ C$ ,  $R_F = 180\Omega$ ,  $R_G = 20\Omega$ ,  $R_L = 500\Omega$  unless otherwise specified. (Continued)

PARAMETER	DESCRIPTION	CONDITIONS	MIN	TYP	MAX	UNIT
$I_N$	Current Noise Spectral Density	10kHz		2.1		pA/ $\sqrt{Hz}$
HD2	2nd Harmonic Distortion (Note 3)			-73		dBc
HD3	3rd Harmonic Distortion			-96		dBc

NOTES:

1. Measured by moving the supplies from  $\pm 13.5V$  to  $\pm 16.5V$
2. Pulse test only
3. Frequency = 1MHz,  $V_{OUT} = 2V_{P-P}$ , into  $500\Omega$  and  $5pF$  load

**Typical Performance Curves**

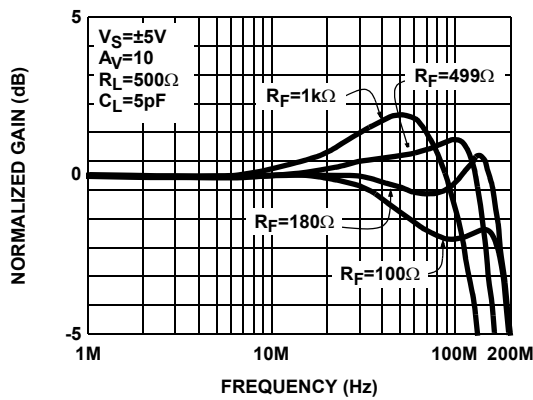

FIGURE 1. NON-INVERTING FREQUENCY RESPONSE FOR VARIOUS  $R_F$

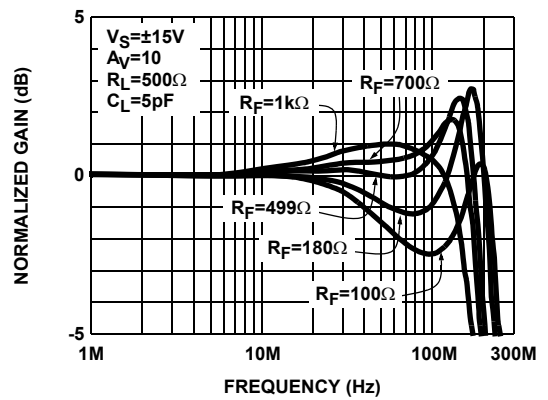

FIGURE 2. NON-INVERTING FREQUENCY RESPONSE FOR VARIOUS  $R_F$

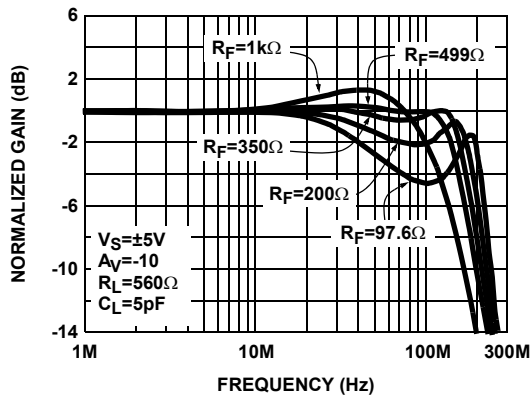

FIGURE 3. INVERTING FREQUENCY RESPONSE FOR VARIOUS  $R_F$

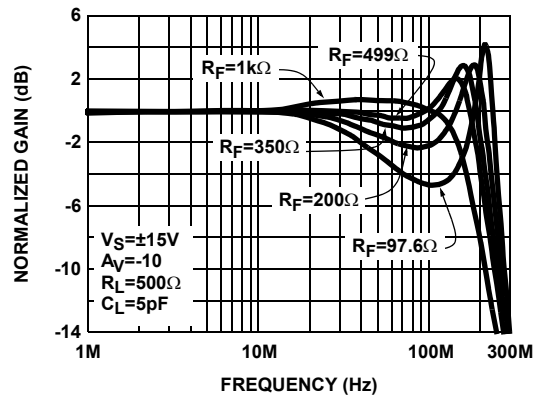

FIGURE 4. INVERTING FREQUENCY RESPONSE FOR VARIOUS  $R_F$

Typical Performance Curves (Continued)

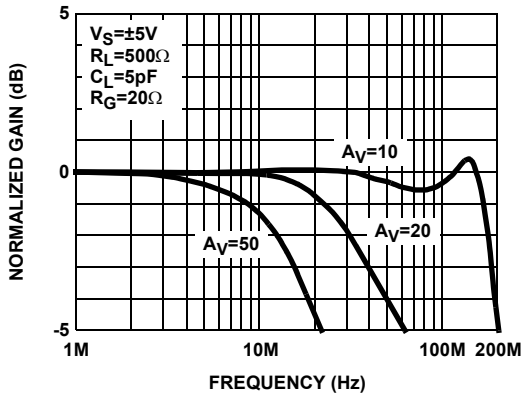

FIGURE 5. NON-INVERTING FREQUENCY RESPONSE vs GAIN

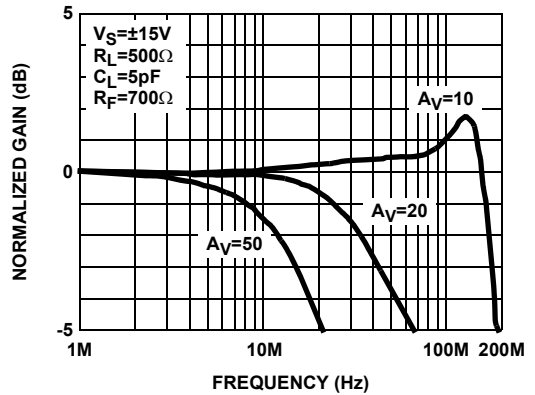

FIGURE 6. NON-INVERTING FREQUENCY RESPONSE FOR VARIOUS GAIN

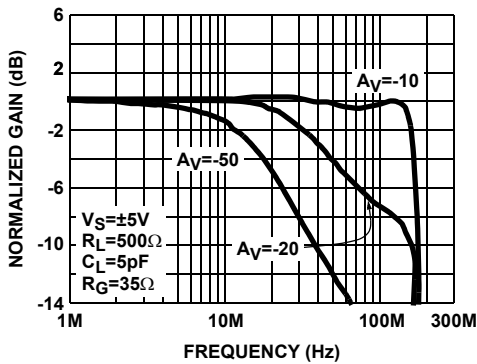

FIGURE 7. INVERTING FREQUENCY RESPONSE vs GAIN

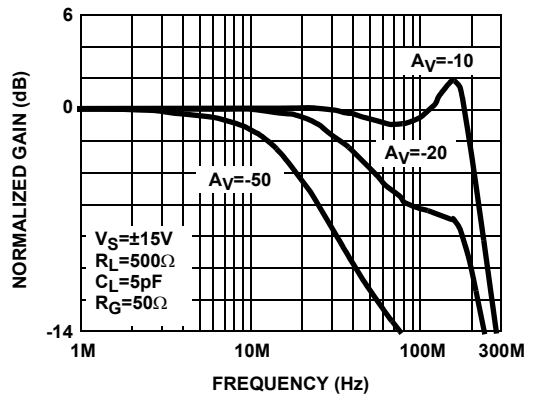

FIGURE 8. INVERTING FREQUENCY RESPONSE vs GAIN

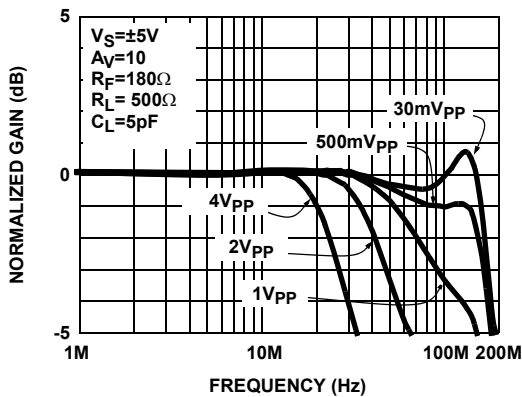

FIGURE 9. NON-INVERTING FREQUENCY RESPONSE FOR VARIOUS OUTPUT SIGNAL LEVELS

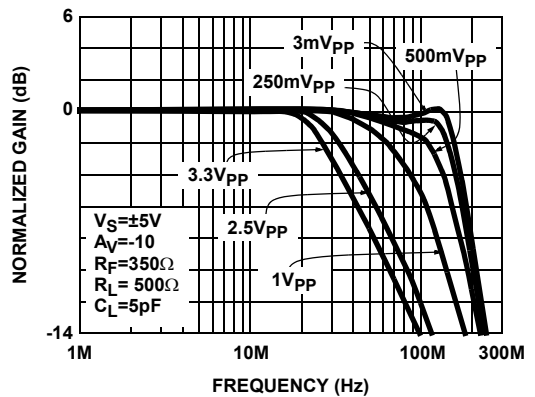

FIGURE 10. INVERTING FREQUENCY RESPONSE FOR VARIOUS OUTPUT SIGNAL LEVELS

Typical Performance Curves (Continued)

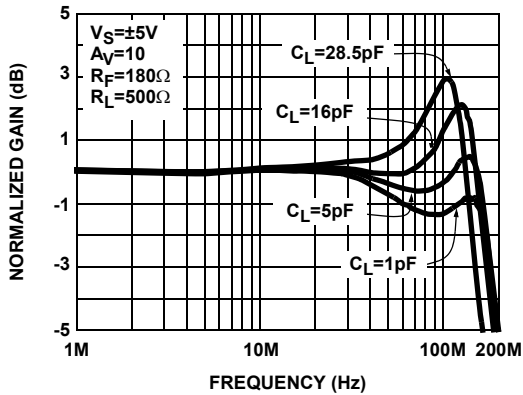

FIGURE 11. NON-INVERTING FREQUENCY RESPONSE FOR VARIOUS  $C_L$

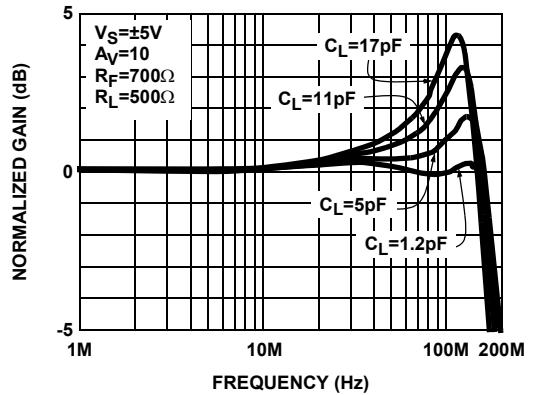

FIGURE 12. NON-INVERTING FREQUENCY RESPONSE FOR VARIOUS  $C_L$

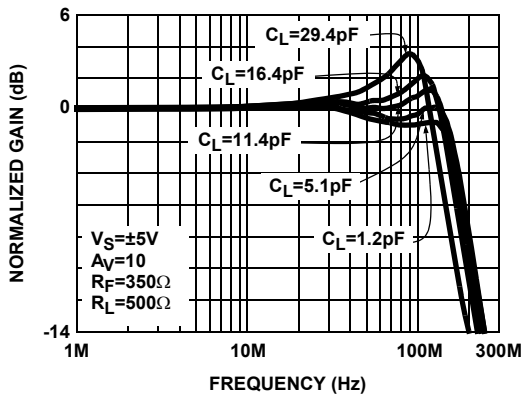

FIGURE 13. INVERTING FREQUENCY RESPONSE FOR VARIOUS  $C_L$

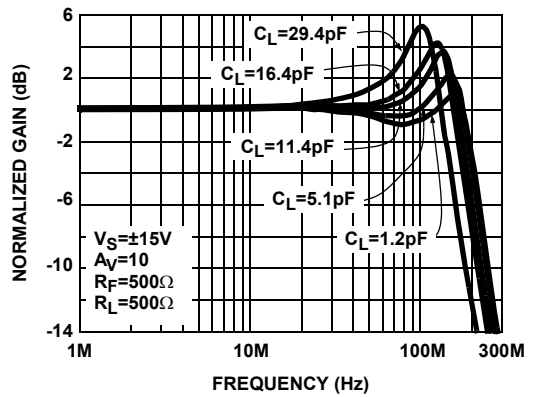

FIGURE 14. INVERTING FREQUENCY RESPONSE FOR VARIOUS  $C_L$

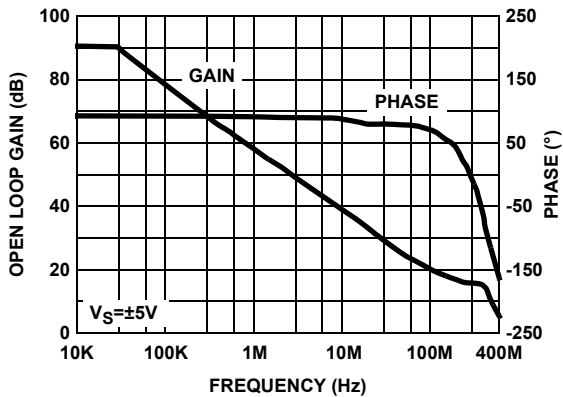

FIGURE 15. OPEN LOOP GAIN AND PHASE

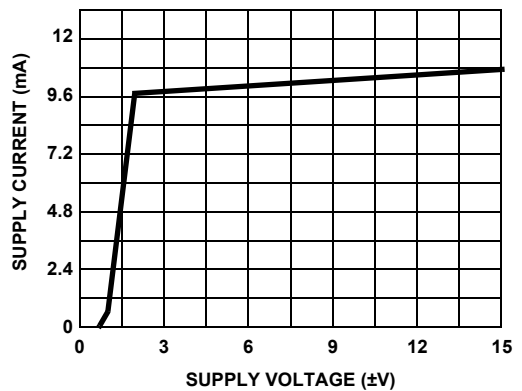

FIGURE 16. SUPPLY CURRENT vs SUPPLY VOLTAGE

Typical Performance Curves (Continued)

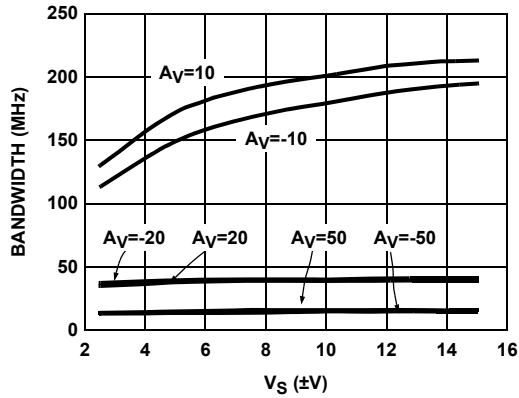

FIGURE 17. 3dB BANDWIDTH vs SUPPLY VOLTAGE

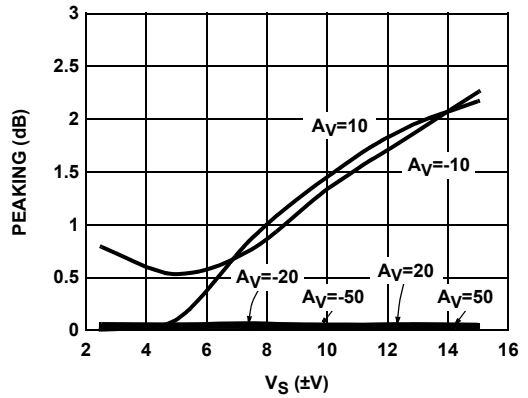

FIGURE 18. PEAKING vs SUPPLY VOLTAGE

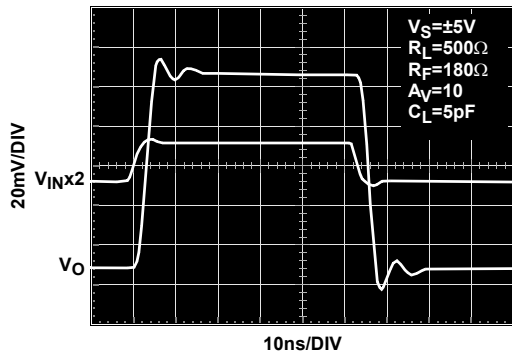

FIGURE 19. SMALL SIGNAL STEP RESPONSE

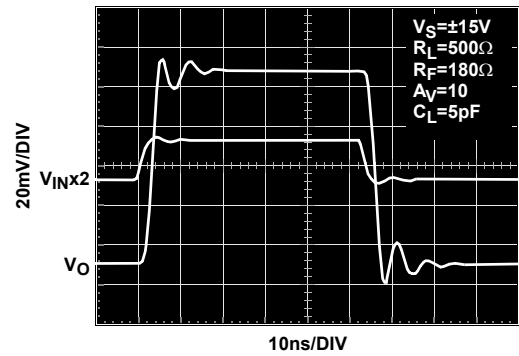

FIGURE 20. SMALL SIGNAL STEP RESPONSE

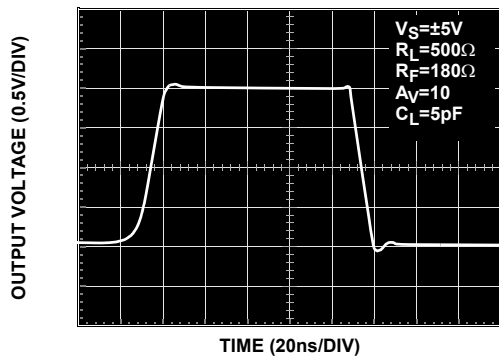

FIGURE 21. LARGE SIGNAL STEP RESPONSE

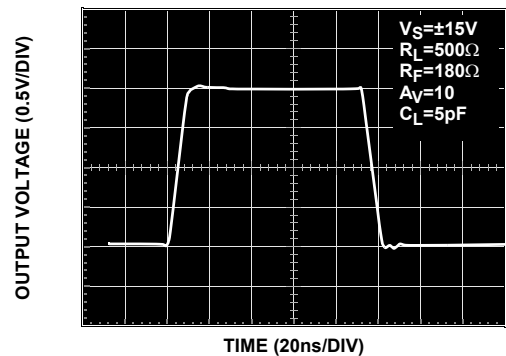

FIGURE 22. LARGE SIGNAL STEP RESPONSE

Typical Performance Curves (Continued)

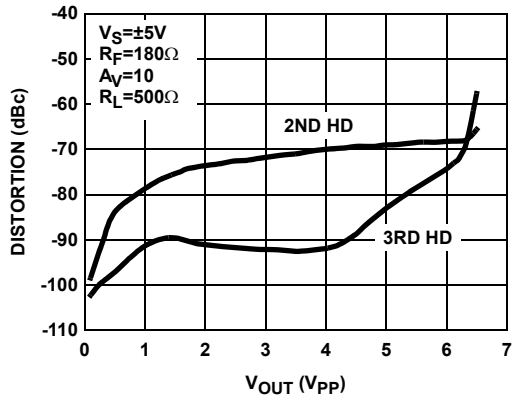

FIGURE 23. 1MHz HARMONIC DISTORTION vs OUTPUT SWING

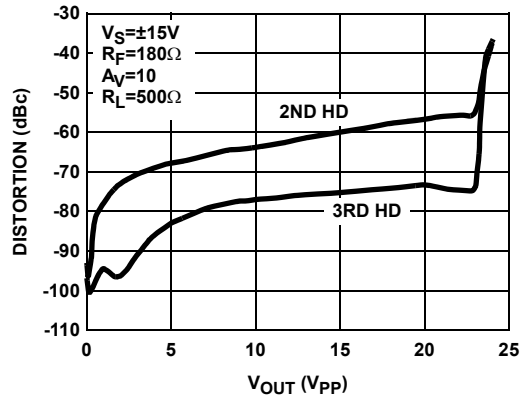

FIGURE 24. 1MHz HARMONIC DISTORTION vs OUTPUT SWING

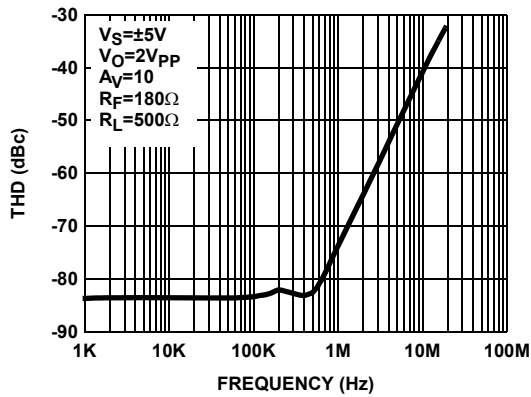

FIGURE 25. TOTAL HARMONIC DISTORTION vs FREQUENCY

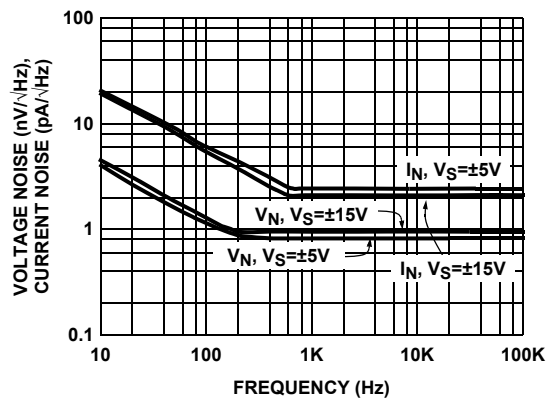

FIGURE 26. VOLTAGE AND CURRENT NOISE vs FREQUENCY

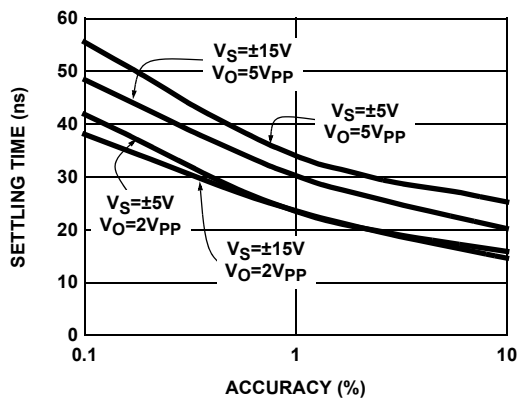

FIGURE 27. SETTLING TIME vs ACCURACY

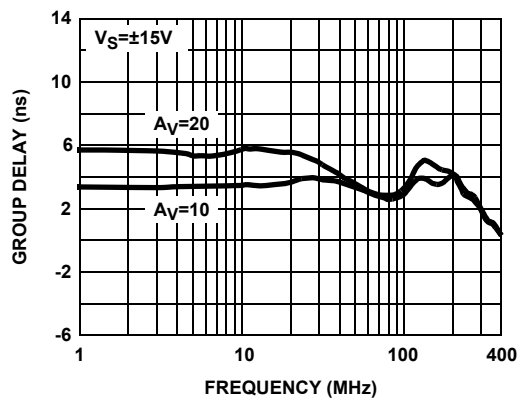

FIGURE 28. GROUP DELAY



Typical Performance Curves (Continued)

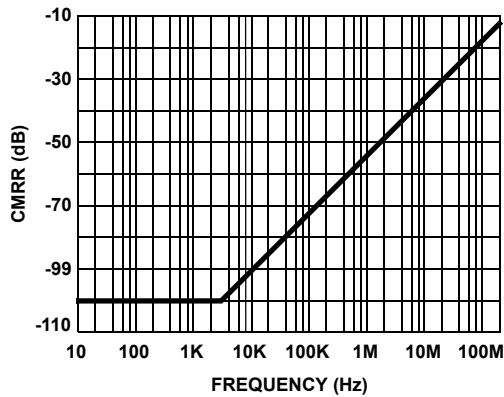

FIGURE 29. CMRR

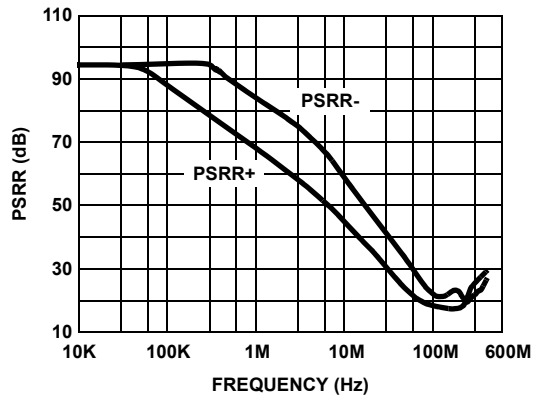

FIGURE 30. PSRR

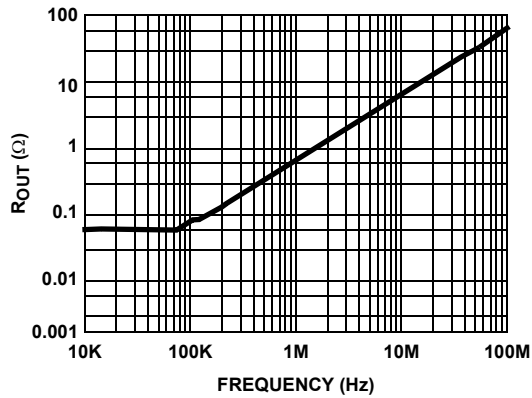

FIGURE 31. CLOSED LOOP OUTPUT IMPEDANCE vs FREQUENCY

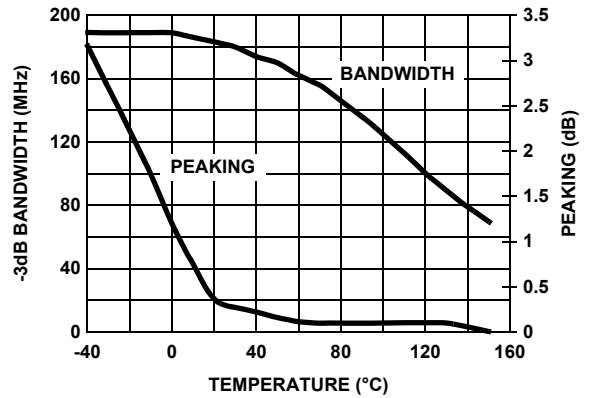

FIGURE 32. BANDWIDTH vs TEMPERATURE

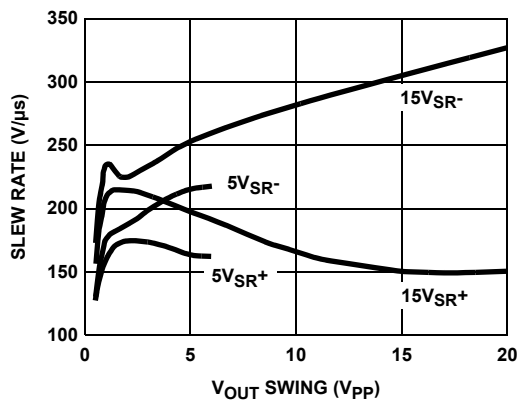

FIGURE 33. SLEW RATE vs SWING

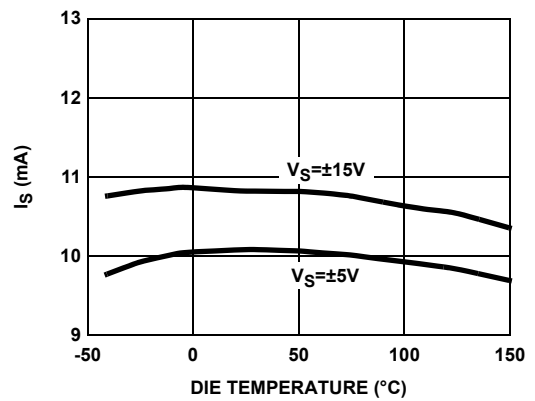

FIGURE 34. SUPPLY CURRENT vs TEMPERATURE

Typical Performance Curves (Continued)

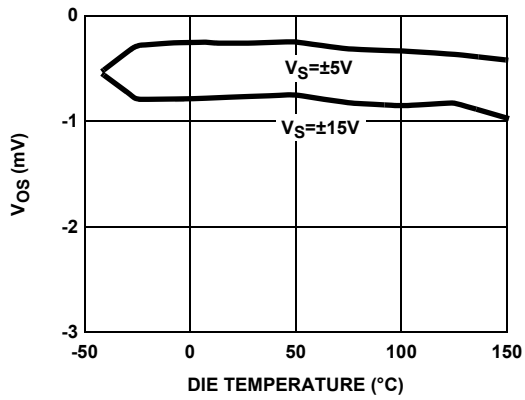

FIGURE 35. OFFSET VOLTAGE vs TEMPERATURE

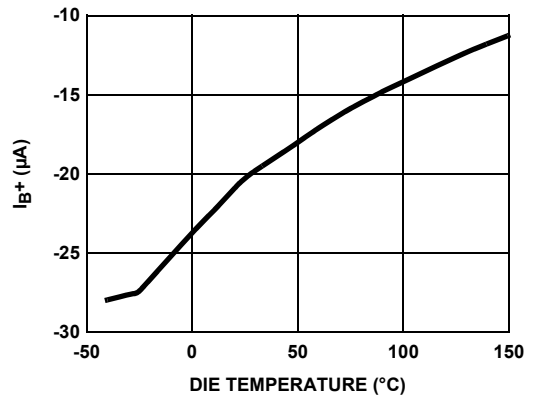

FIGURE 36. INPUT BIAS CURRENT vs TEMPERATURE

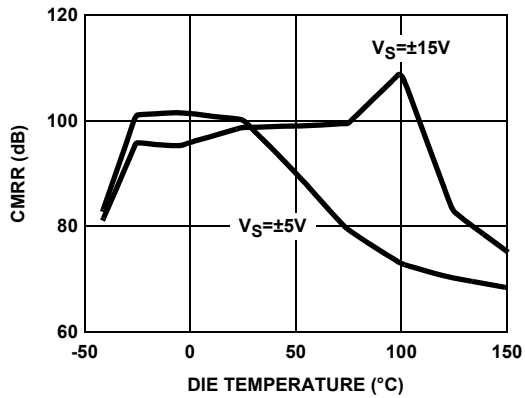

FIGURE 37. CMRR vs TEMPERATURE

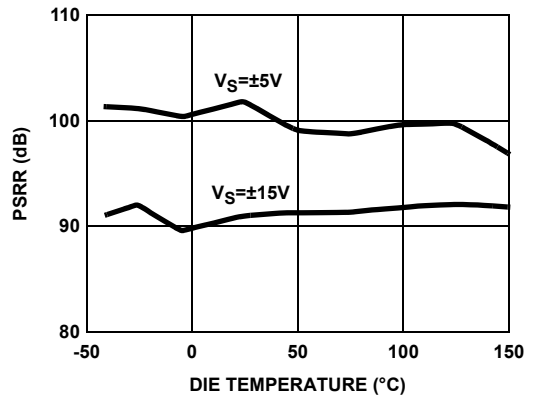

FIGURE 38. PSRR vs TEMPERATURE

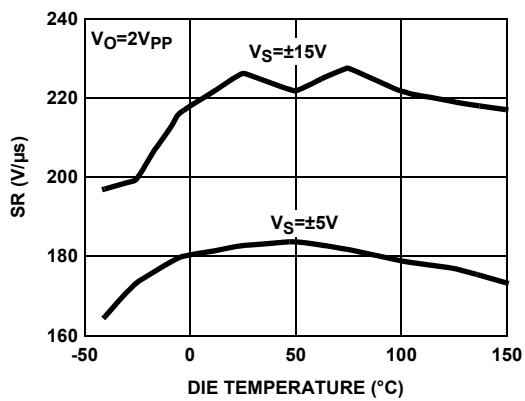

FIGURE 39. SLEW RATE vs TEMPERATURE

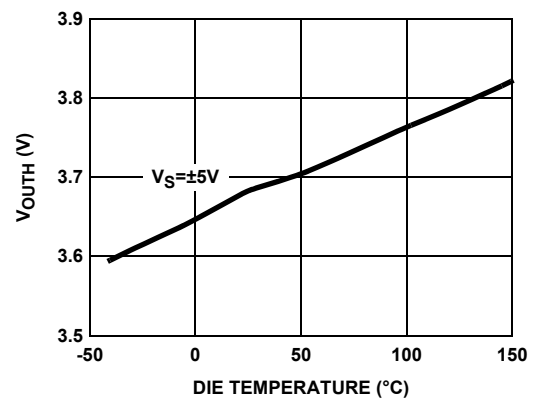

FIGURE 40. POSITIVE OUTPUT SWING vs TEMPERATURE

Typical Performance Curves (Continued)

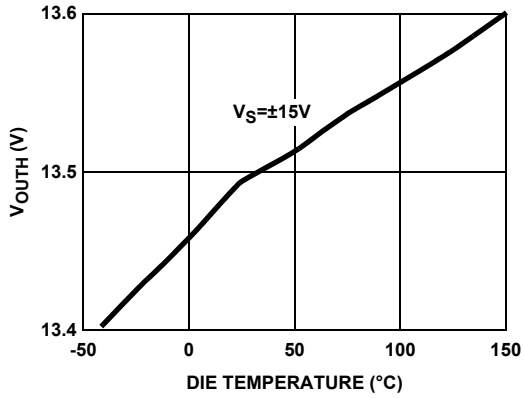

FIGURE 41. POSITIVE OUTPUT SWING vs TEMPERATURE

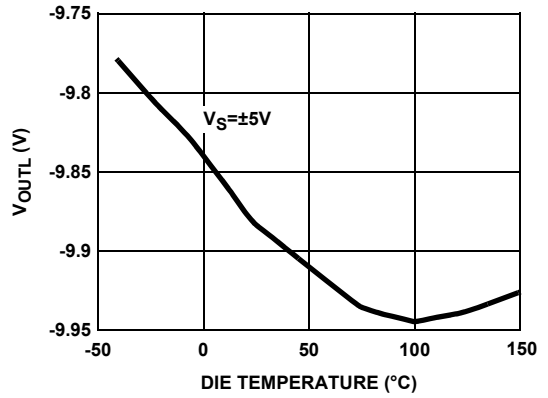

FIGURE 42. NEGATIVE OUTPUT SWING vs TEMPERATURE

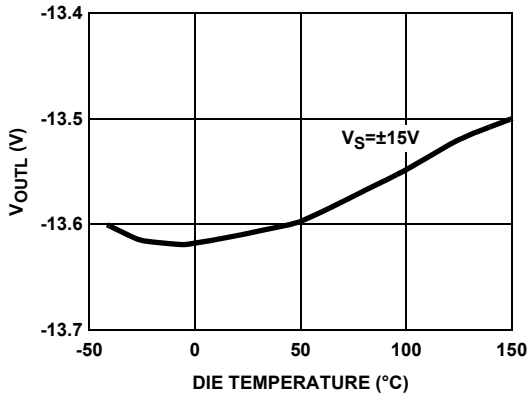

FIGURE 43. NEGATIVE OUTPUT SWING vs TEMPERATURE

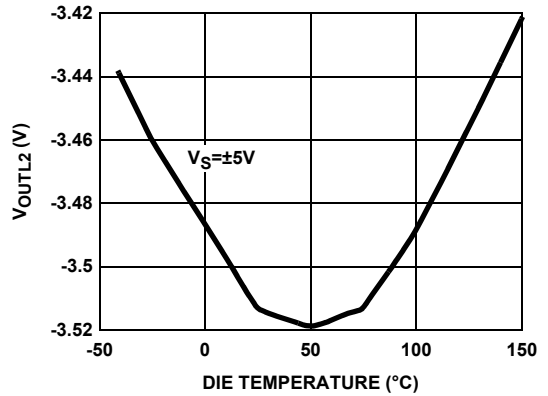

FIGURE 44. LOADED NEGATIVE OUTPUT SWING vs TEMPERATURE

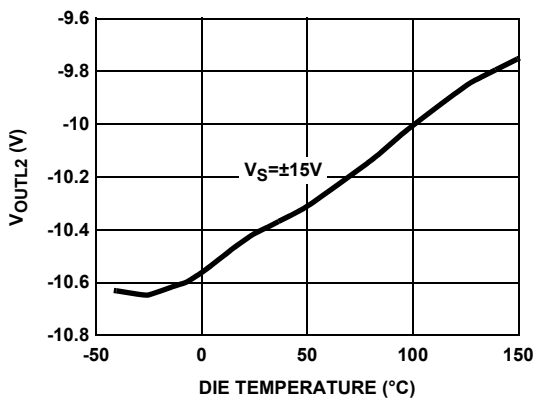

FIGURE 45. NEGATIVE OUTPUT SWING vs TEMPERATURE

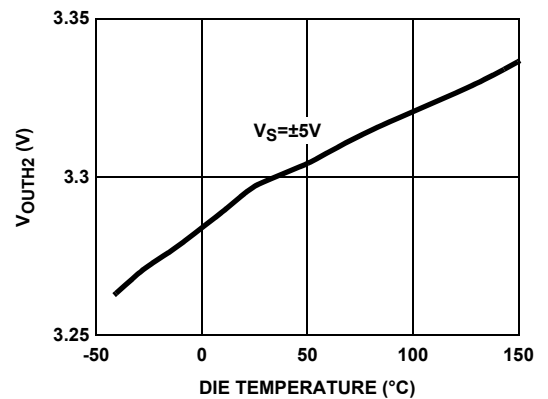

FIGURE 46. LOADED POSITIVE OUTPUT SWING vs TEMPERATURE

Typical Performance Curves (Continued)

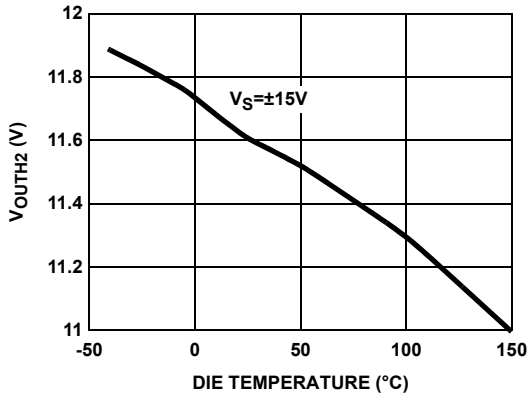

FIGURE 47. LOADED POSITIVE OUTPUT SWING vs TEMPERATURE

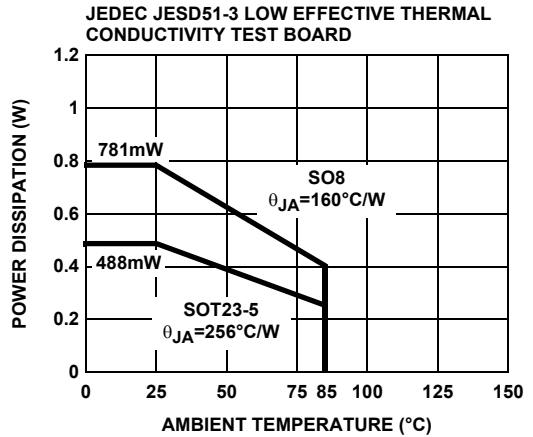

FIGURE 48. PACKAGE POWER DISSIPATION vs AMBIENT TEMPERATURE

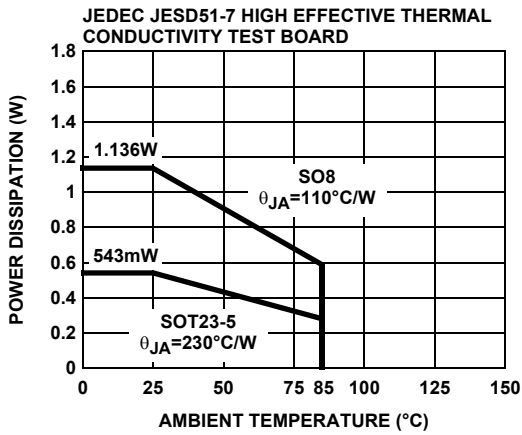

FIGURE 49. PACKAGE POWER DISSIPATION vs AMBIENT TEMPERATURE

**Pin Descriptions**

5-PIN SOT-23	8-PIN SO	PIN NAME	PIN FUNCTION	EQUIVALENT CIRCUIT
1	6	VOUT	Output	<p>CIRCUIT 1</p>
2	4	VS-	Supply	
3	3	VINA+	Input	<p>CIRCUIT 2</p>
4	2	VINA-	Input	Reference Circuit 2
5	7	VS+	Supply	

**Applications Information**

**Product Description**

The EL2125 is an ultra-low noise, wideband monolithic operational amplifier built on Elantec's proprietary high speed complementary bipolar process. It features 0.83nV/√Hz input voltage noise, 200μV offset voltage, and 73dB THD. It is intended for use in systems such as ultrasound imaging where very small signals are needed to be amplified. The EL2125 also has excellent DC specifications: 200μV  $V_{OS}$ , 22μA  $I_B$ , 0.4μA  $I_{OS}$ , and 106dB CMRR. These specifications allow the EL2125 to be used in DC-sensitive applications such as difference amplifiers.

**Gain-Bandwidth Product**

The EL2125 has a gain-bandwidth product of 800MHz at ±5V. For gains greater than 20, its closed-loop -3dB bandwidth is approximately equal to the gain-bandwidth product divided by the small signal gain of the circuit. For gains less than 20, higher-order poles in the amplifier's transfer function contribute to even higher closed-loop bandwidths. For example, the EL2125 has a -3dB bandwidth of 175MHz at a gain of 10 and decreases to 40MHz at gain of 20. It is important to note that the extra bandwidth at lower gain does not come at the expenses of stability. Even though the EL2125 is designed for gain > 10 with external

compensation, the device can also operate at lower gain settings. The RC network shown in Figure 50 reduces the feedback gain at high frequency and thus maintains the amplifier stability. R values must be less than  $R_F$  divided by 9 and  $1$  divided by  $2\pi RC$  must be less than 400MHz.

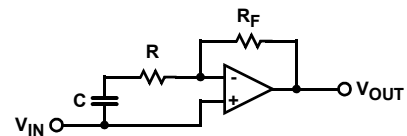

FIGURE 50.

**Choice of Feedback Resistor,  $R_F$**

The feedback resistor forms a pole with the input capacitance. As this pole becomes larger, phase margin is reduced. This increases ringing in the time domain and peaking in the frequency domain. Therefore,  $R_F$  has some maximum value which should not be exceeded for optimum performance. If a large value of  $R_F$  must be used, a small capacitor in the few pF range in parallel with  $R_F$  can help to reduce this ringing and peaking at the expense of reducing the bandwidth. Frequency response curves for various  $R_F$  values are shown in the typical performance curves section of this data sheet.

**Noise Calculations**

The primary application for the EL2125 is to amplify very small signals. To maintain the proper signal-to-noise ratio, it is essential to minimize noise contribution from the amplifier. Figure 51 below shows all the noise sources for all the components around the amplifier.

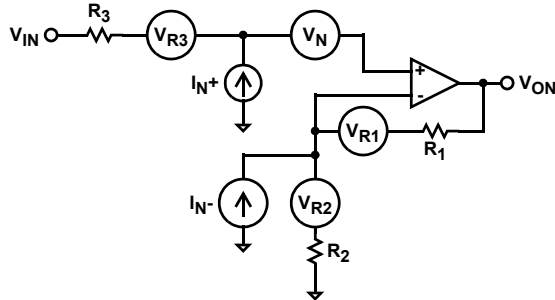

FIGURE 51.

- $V_N$  is the amplifier input voltage noise
- $I_{N+}$  is the amplifier positive input current noise
- $I_{N-}$  is the amplifier negative input current noise
- $V_{RX}$  is the thermal noise associated with each resistor:

$$V_{RX} = \sqrt{4kTRx}$$

where:

- $k$  is Boltzmann's constant =  $1.380658 \times 10^{-23}$
- $T$  is temperature in degrees Kelvin ( $273+ \text{ }^\circ\text{C}$ )

The total noise due to the amplifier seen at the output of the amplifier can be calculated by using the equation below (Figure 52).

As the equation shows, to keep noise at a minimum, small resistor values should be used. At higher amplifier gain configuration where  $R_2$  is reduced, the noise due to  $I_{N-}$ ,  $R_2$ , and  $R_1$  decreases and the noise caused by  $I_{N+}$ ,  $V_N$ , and  $R_3$  starts to dominate. Because noise is summed in a root-mean-squares method, noise sources smaller than 25% of the largest noise source can be ignored. This can greatly simplify the formula and make noise calculation much easier to calculate.

**Output Drive Capability**

The EL2125 is designed to drive low impedance load. It can easily drive  $6V_{P-P}$  signal into a  $100\Omega$  load. This high output drive capability makes the EL2125 an ideal choice for RF, IF, and video applications. Furthermore, the EL2125 is current-

limited at the output, allowing it to withstand momentary short to ground. However, the power dissipation with output shorted cannot exceed the power dissipation capability of the package.

**Driving Cables and Capacitive Loads**

Although the EL2125 is designed to drive low impedance load, capacitive loads will decrease the amplifier's phase margin. As shown in the performance curves, capacitive load can result in peaking, overshoot and possible oscillation. For optimum AC performance, capacitive loads should be reduced as much as possible or isolated with a series resistor between  $5\Omega$  to  $20\Omega$ . When driving coaxial cables, double termination is always recommended for reflection-free performance. When properly terminated, the capacitance of the coaxial cable will not add to the capacitive load seen by the amplifier.

**Power Supply Bypassing And Printed Circuit Board Layout**

As with any high frequency devices, good printed circuit board layout is essential for optimum performance. Ground plane construction is highly recommended. Lead lengths should be kept as short as possible. The power supply pins must be closely bypassed to reduce the risk of oscillation. The combination of a  $4.7\mu\text{F}$  tantalum capacitor in parallel with  $0.1\mu\text{F}$  ceramic capacitor has been proven to work well when placed at each supply pin. For single supply operation, where pin 4 ( $V_{S-}$ ) is connected to the ground plane, a single  $4.7\mu\text{F}$  tantalum capacitor in parallel with a  $0.1\mu\text{F}$  ceramic capacitor across pins 7 ( $V_{S+}$ ) and pin 4 ( $V_{S-}$ ) will suffice.

For good AC performance, parasitic capacitance should be kept to a minimum. Ground plane construction again should be used. Small chip resistors are recommended to minimize series inductance. Use of sockets should be avoided since they add parasitic inductance and capacitance which will result in additional peaking and overshoot.

**Supply Voltage Range and Single Supply Operation**

The EL2125 has been designed to operate with supply voltage range of  $\pm 2.5\text{V}$  to  $\pm 15\text{V}$ . With a single supply, the EL2125 will operate from  $+5\text{V}$  to  $+30\text{V}$ . Pins 4 and 7 are the power supply pins. The positive power supply is connected to pin 7. When used in single supply mode, pin 4 is connected to ground. When used in dual supply mode, the negative power supply is connected to pin 4.

As the power supply voltage decreases from  $+30\text{V}$  to  $+5\text{V}$ , it becomes necessary to pay special attention to the input

$$V_{ON} = \sqrt{BW} \times \sqrt{\left( V_N^2 \times \left( 1 + \frac{R_1}{R_2} \right)^2 + I_{N-}^2 \times R_1^2 + I_{N+}^2 \times R_3^2 \times \left( 1 + \frac{R_1}{R_2} \right)^2 + 4 \times K \times T \times R_1 + 4 \times K \times T \times R_2 \times \left( \frac{R_1}{R_2} \right)^2 + 4 \times K \times T \times R_3 \times \left( 1 + \frac{R_1}{R_2} \right)^2 \right)}$$

FIGURE 52.

voltage range. The EL2125 has an input voltage range of 0.4V from the negative supply to 1.2V from the positive supply. So, for example, on a single +5V supply, the EL2125 has an input voltage range which spans from 0.4V to 3.8V. The output range of the EL2125 is also quite large, on a +5V supply, it swings from 0.4V to 3.6V.

All Intersil U.S. products are manufactured, assembled and tested utilizing ISO9000 quality systems. Intersil Corporation's quality certifications can be viewed at [www.intersil.com/design/quality](http://www.intersil.com/design/quality)

---

*Intersil products are sold by description only. Intersil Corporation reserves the right to make changes in circuit design, software and/or specifications at any time without notice. Accordingly, the reader is cautioned to verify that data sheets are current before placing orders. Information furnished by Intersil is believed to be accurate and reliable. However, no responsibility is assumed by Intersil or its subsidiaries for its use; nor for any infringements of patents or other rights of third parties which may result from its use. No license is granted by implication or otherwise under any patent or patent rights of Intersil or its subsidiaries.*

---

For information regarding Intersil Corporation and its products, see [www.intersil.com](http://www.intersil.com)