

125MHz Single Supply Dual/Quad Op Amps

The EL2250/EL2450 are part of a family of the electronics industries fastest single supply op amps available. Prior single supply op amps have generally been limited to bandwidths and slew rates to that of the EL2250/EL2450. The 125MHz bandwidth, 275V/ μ s slew rate, and 0.05%/0.05° differential gain/differential phase makes this part ideal for single or dual supply video speed applications. With its voltage feedback architecture, this amplifier can accept reactive feedback networks, allowing them to be used in analog filtering applications. The inputs can sense signals below the bottom supply rail and as high as 1.2V below the top rail. Connecting the load resistor to ground and operating from a single supply, the outputs swing completely to ground without saturating. The outputs can also drive to within 1.2V of the top rail. The EL2250/EL2450 will output \pm 100mA and will operate with single supply voltages as low as 2.7V, making them ideal for portable, low power applications.

The EL2250/EL2450 are available in PDIP and SO packages in industry standard pin outs. Both parts operate over the industrial temperature range of -40°C to +85°C, and are part of a family of single supply op amps. For single amplifier applications, see the EL2150/EL2157. For dual and triple amplifiers with power down and output voltage clamps, see the EL2257/EL2357.

Ordering Information

PART NUMBER	PACKAGE	TAPE & REEL	PKG. DWG. #
EL2250CN	8-Pin PDIP	-	MDP0031
EL2250CS	8-Pin SO	-	MDP0027
EL2250CS-T7	8-Pin SO	7"	MDP0027
EL2250CS-T13	8-Pin SO	13"	MDP0027
EL2250CSZ (See Note)	8-Pin SO (Pb-free)	-	MDP0027
EL2250CSZ-T7 (See Note)	8-Pin SO (Pb-free)	7"	MDP0027
EL2250CSZ-T13 (See Note)	8-Pin SO (Pb-free)	13"	MDP0027
EL2450CN	14-Pin PDIP	-	MDP0031
EL2450CS	14-Pin SO	-	MDP0027
EL2450CS-T7	14-Pin SO	7"	MDP0027
EL2450CS-T13	14-Pin SO	13"	MDP0027

NOTE: Intersil Pb-free plus anneal products employ special Pb-free material sets; molding compounds/die attach materials and 100% matte tin plate termination finish, which are RoHS compliant and compatible with both SnPb and Pb-free soldering operations. Intersil Pb-free products are MSL classified at Pb-free peak reflow temperatures that meet or exceed the Pb-free requirements of IPC/JEDEC J STD-020.

Features

- Specified for +3V, +5V, or \pm 5V applications
- Large input common mode range
 $0V < V_{CM} < V_S - 1.2V$
- Output swings to ground without saturating
- -3dB bandwidth = 125MHz
- \pm 0.1dB bandwidth = 30MHz
- Low supply current = 5mA (per amplifier)
- Slew rate = 275V/ μ s
- Low offset voltage = 4mV max
- Output current = \pm 100mA
- High open loop gain = 80dB
- Differential gain = 0.05%
- Differential phase = 0.05°
- Pb-free plus anneal available (RoHS compliant)

Applications

- Video amplifiers
- PCMCIA applications
- A/D drivers
- Line drivers
- Portable computers
- High speed communications
- RGB printers, FAX, scanners
- Broadcast equipment
- Active filtering

Pinouts

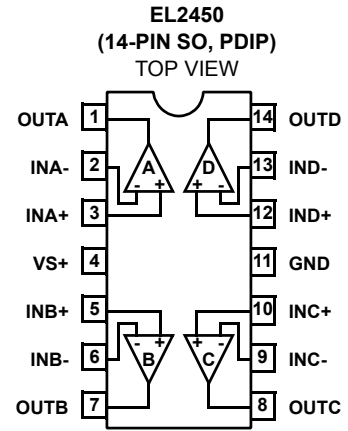
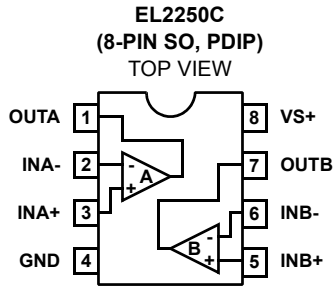

EL2250, EL2450

Absolute Maximum Ratings ($T_A = 25^\circ\text{C}$)

Supply Voltage between V_S and GND +12.6V	Power Dissipation See Curves
Input Voltage (IN+, IN-) GND-0.3V, V_S +0.3V	Storage Temperature Range -65°C to +150°C
Differential Input Voltage $\pm 6\text{V}$	Ambient Operating Temperature Range -40°C to +85°C
Maximum Output Current 90mA	Operating Junction Temperature 150°C
Output Short Circuit Duration (Note 1)	

CAUTION: Stresses above those listed in "Absolute Maximum Ratings" may cause permanent damage to the device. This is a stress only rating and operation of the device at these or any other conditions above those indicated in the operational sections of this specification is not implied.

IMPORTANT NOTE: All parameters having Min/Max specifications are guaranteed. Typical values are for information purposes only. Unless otherwise noted, all tests are at the specified temperature and are pulsed tests, therefore: $T_J = T_C = T_A$

DC Electrical Specifications $V_S = +5\text{V}$, GND = 0V, $T_A = 25^\circ\text{C}$, $V_{CM} = 1.5\text{V}$, $V_{OUT} = 1.5\text{V}$, unless otherwise specified.

PARAMETER	DESCRIPTION	TEST CONDITIONS	MIN	TYP	MAX	UNIT
V_{OS}	Offset Voltage	EL2250	-2		2	mV
		EL2450	-4		4	mV
TCV_{OS}	Offset Voltage Temperature Coefficient	Measured from T_{MIN} to T_{MAX}		10		$\mu\text{V}/^\circ\text{C}$
I_B	Input Bias Current	$V_{IN} = 0\text{V}$		-5.5	-10	μA
I_{OS}	Input Offset Current	$V_{IN} = 0\text{V}$	-750	150	750	nA
TCI_{OS}	Input Bias Current Temperature Coefficient	Measured from T_{MIN} to T_{MAX}		50		$\text{nA}/^\circ\text{C}$
PSRR	Power Supply Rejection Ratio	$V_S = +2.7\text{V}$ to +12V	55	70		dB
CMRR	Common Mode Rejection Ratio	$V_{CM} = 0\text{V}$ to +3.8V	55	65		dB
		$V_{CM} = 0\text{V}$ to +3.0V	55	70		dB
CMIR	Common Mode Input Range		0		$V_S - 1.2$	V
R_{IN}	Input Resistance	Common Mode	1	2		$\text{M}\Omega$
C_{IN}	Input Capacitance	SO Package		1		pF
		PDIP Package		1.5		pF
R_{OUT}	Output Resistance	$A_V = +1$		40		$\text{m}\Omega$
I_S	Supply Current (per amplifier)	$V_S = +12\text{V}$		5	6.5	mA
PSOR	Power Supply Operating Range		2.7		12.0	V

DC Electrical Specifications $V_S = +5\text{V}$, GND = 0V, $T_A = 25^\circ\text{C}$, $V_{CM} = +1.5\text{V}$, $V_{OUT} = +1.5\text{V}$, unless otherwise specified.

PARAMETER	DESCRIPTION	TEST CONDITIONS	MIN	TYP	MAX	UNIT
AVOL	Open Loop Gain	$V_S = +12\text{V}$, $V_{OUT} = +2\text{V}$ to +9V, $R_L = 1\text{k}\Omega$ to GND	60	80		dB
		$V_{OUT} = +1.5\text{V}$ to +3.5V, $R_L = 1\text{k}\Omega$ to GND		70		dB
		$V_{OUT} = +1.5\text{V}$ to +3.5V, $R_L = 150\Omega$ to GND		60		dB
V_{OP}	Positive Output Voltage Swing	$V_S = +12\text{V}$, $A_V = +1$, $R_L = 1\text{k}\Omega$ to 0V		10.8		V
		$V_S = +12\text{V}$, $A_V = +1$, $R_L = 150\Omega$ to 0V	9.6	10.0		V
		$V_S = \pm 5\text{V}$, $A_V = +1$, $R_L = 1\text{k}\Omega$ to 0V		4.0		V
		$V_S = \pm 5\text{V}$, $A_V = +1$, $R_L = 150\Omega$ to 0V	3.4	3.8		V
		$V_S = +3\text{V}$, $A_V = +1$, $R_L = 150\Omega$ to 0V	1.8	1.95		V
V_{ON}	Negative Output Voltage Swing	$V_S = +12\text{V}$, $A_V = +1$, $R_L = 150\Omega$ to 0V		5.5	8	mV
		$V_S = \pm 5\text{V}$, $A_V = +1$, $R_L = 1\text{k}\Omega$ to 0V		-4.0		V
		$V_S = \pm 5\text{V}$, $A_V = +1$, $R_L = 150\Omega$ to 0V		-3.7	-3.4	V
I_{OUT}	Output Current (Note 1)	$V_S = \pm 5\text{V}$, $A_V = +1$, $R_L = 10\Omega$ to 0V	± 75	± 100		mA
		$V_S = \pm 5\text{V}$, $A_V = +1$, $R_L = 50\Omega$ to 0V $\pm 60\text{VmA}$				

NOTE:

- Internal short circuit protection circuitry has been built into the EL2250/EL2450; see the Applications section

EL2250, EL2450

AC Electrical Specifications

$V_S = +5V$, $GND = 0V$, $T_A = 25^\circ C$, $V_{CM} = +1.5V$, $V_{OUT} = +1.5V$, $A_V = +1$, $R_F = 0\Omega$, $R_L = 150\Omega$ to GND pin, unless otherwise specified. (Note 1)

PARAMETER	DESCRIPTION	TEST CONDITIONS	MIN	TYP	MAX	UNIT
BW	-3dB Bandwidth ($V_{OUT}=400mV_{P-P}$)	$V_S = +5V$, $A_V = +1$, $R_F = 0\Omega$		125		MHz
		$V_S = +5V$, $A_V = -1$, $R_F = 500\Omega$		60		MHz
		$V_S = +5V$, $A_V = +2$, $R_F = 500\Omega$		60		MHz
		$V_S = +5V$, $A_V = +10$, $R_F = 500\Omega$		6		MHz
		$V_S = +12V$, $A_V = +1$, $R_F = 0\Omega$		150		MHz
		$V_S = +3V$, $A_V = +1$, $R_F = 0\Omega$		100		MHz
BW	$\pm 0.1dB$ Bandwidth ($V_{OUT}=400mV_{P-P}$)	$V_S = +12V$, $A_V = +1$, $R_F = 0\Omega$		25		MHz
		$V_S = +5V$, $A_V = +1$, $R_F = 0\Omega$		30		MHz
		$V_S = +3V$, $A_V = +1$, $R_F = 0\Omega$		20		MHz
GBWP	Gain Bandwidth Product	$V_S = +12V$, @ $A_V = +10$		60		MHz
PM	Phase Margin	$R_L = 1k\Omega$, $C_L = 6pF$		55		°
SR	Slew Rate	$V_S = +10V$, $R_L = 150\Omega$, $V_{OUT} = 0V$ to $+6V$	200	275		V/ μs
		$V_S = +5V$, $R_L = 150\Omega$, $V_{OUT} = 0V$ to $+3V$		300		V/ μs
t_R , t_F	Rise Time, Fall Time	$\pm 0.1V$ Step		2.8		ns
OS	Overshoot	$\pm 0.1V$ Step		10		%
t_{PD}	Propagation Delay	$\pm 0.1V$ Step		3.2		ns
t_S	0.1% Settling Time	$V_S = \pm 5V$, $R_L = 500\Omega$, $A_V = +1$, $V_{OUT} = \pm 3V$		40		ns
	0.01% Settling Time	$V_S = \pm 5V$, $R_L = 500\Omega$, $A_V = +1$, $V_{OUT} = \pm 3V$		75		ns
dG	Differential Gain (Note 2)	$A_V = +2$, $R_F = 1k\Omega$		0.05		%
dP	Differential Phase (Note 2)	$A_V = +2$, $R_F = 1k\Omega$		0.05		°
e_N	Input Noise Voltage	$f = 10kHz$		48		nV/ \sqrt{Hz}
i_N	Input Noise Current	$f = 10kHz$		1.25		pA/ \sqrt{Hz}

NOTES:

- All AC tests are performed on a "warmed up" part, except slew rate, which is pulse tested
- Standard NTSC signal = $286mV_{P-P}$, $f = 3.58MHz$, as V_{IN} is swept from $0.6V$ to $1.314V$; R_L is DC coupled

Typical Performance Curves

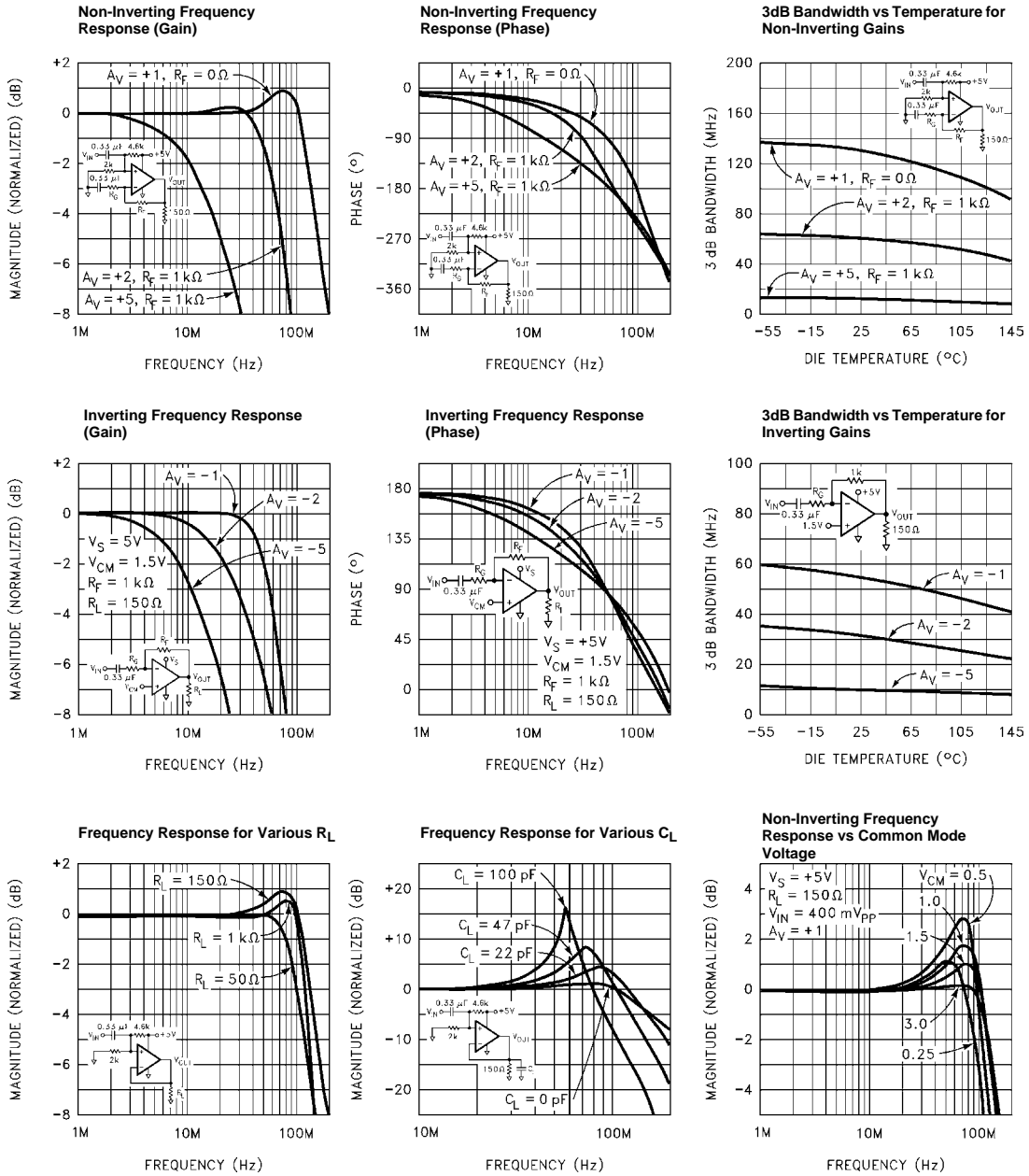

Typical Performance Curves (Continued)

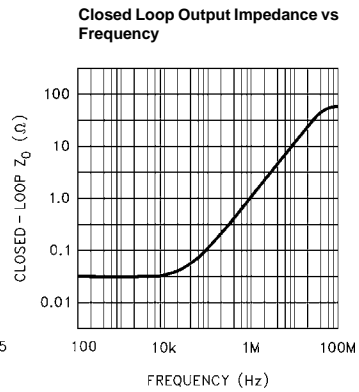
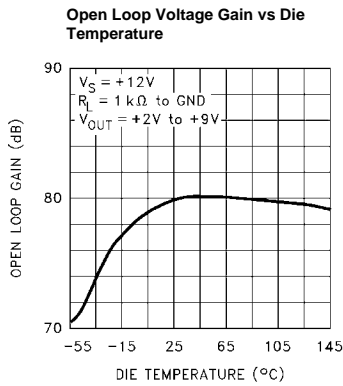
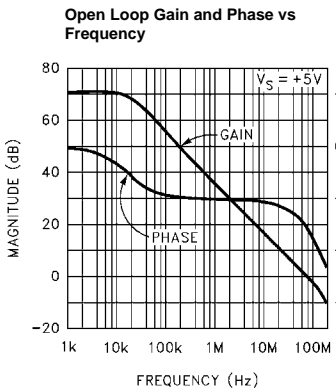
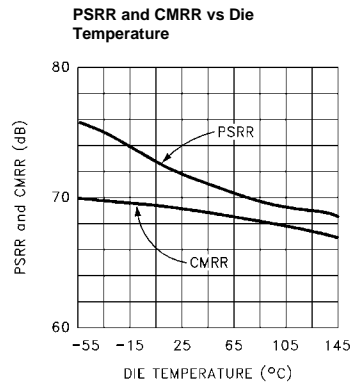
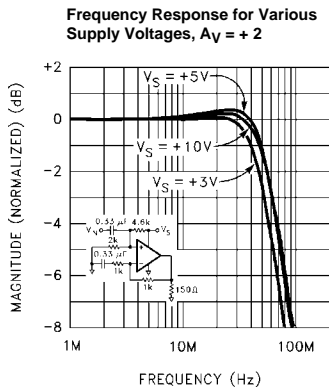
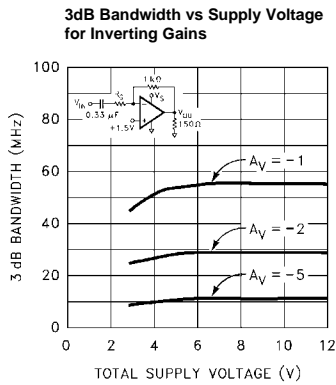
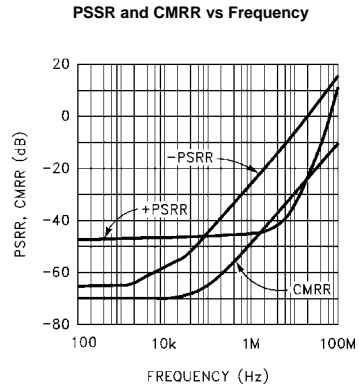
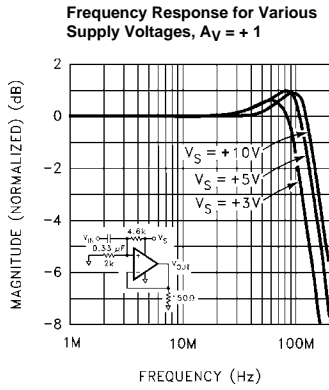
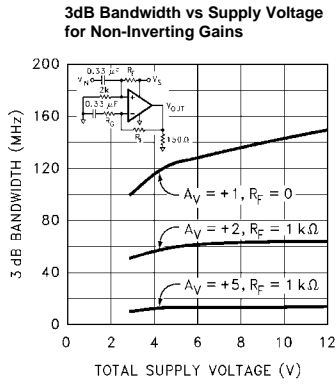

Typical Performance Curves (Continued)

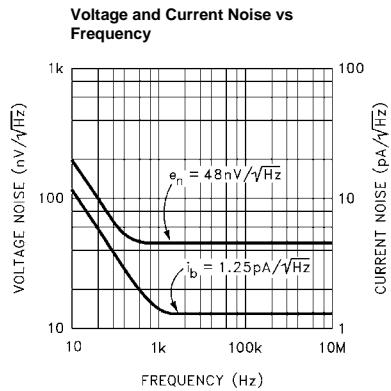
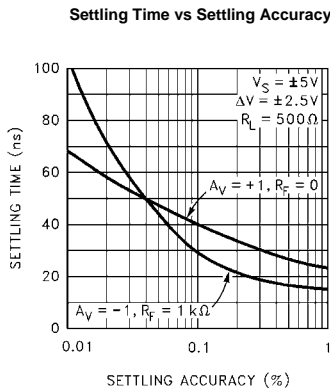
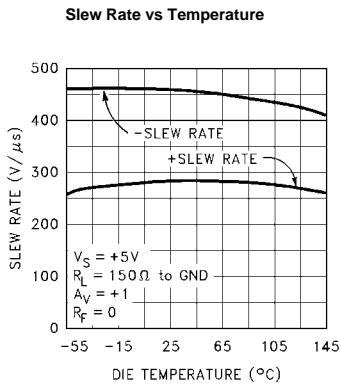
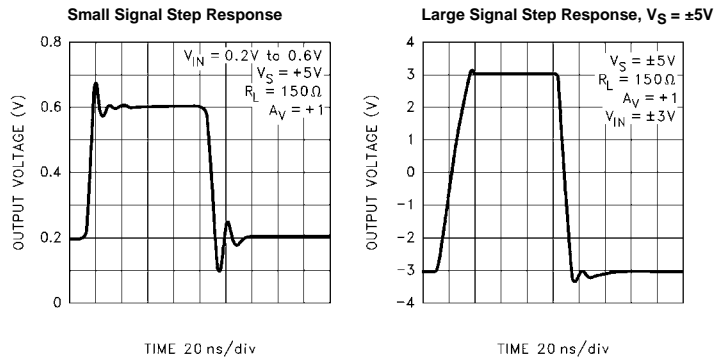
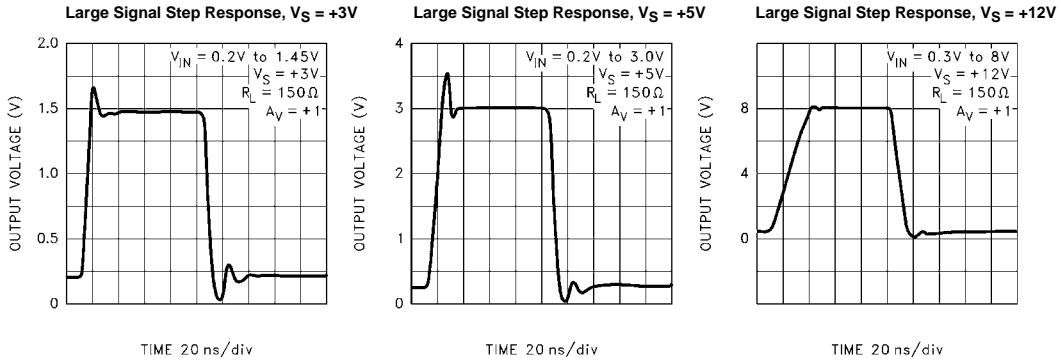

Typical Performance Curves (Continued)

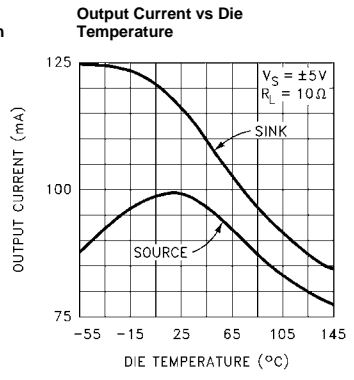
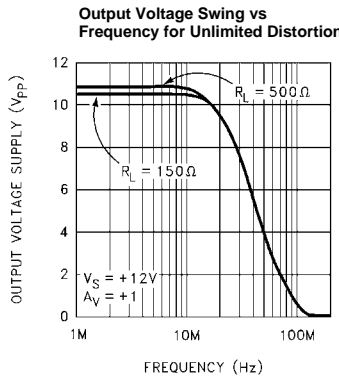
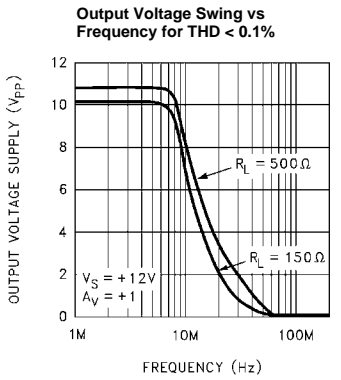
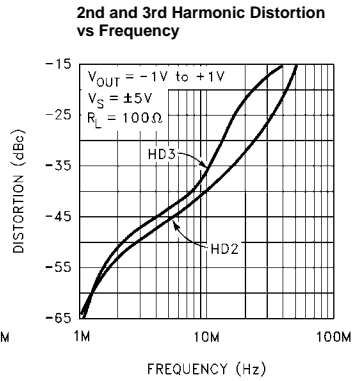
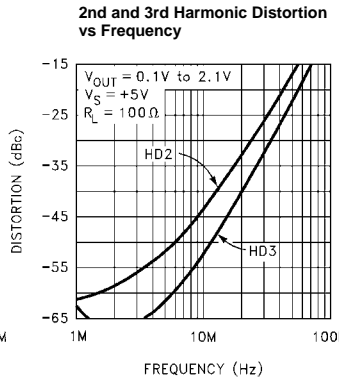
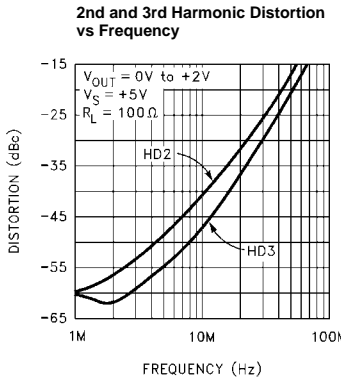
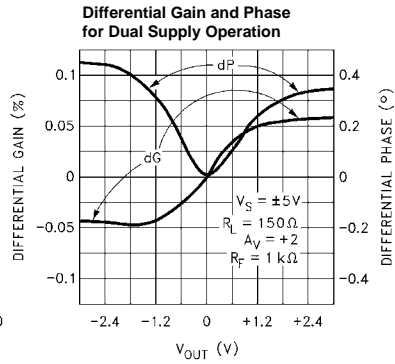
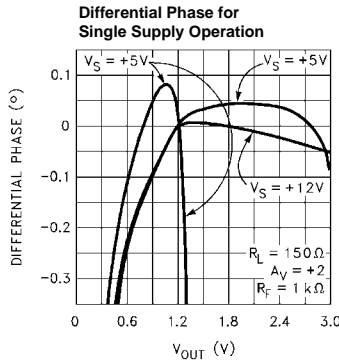
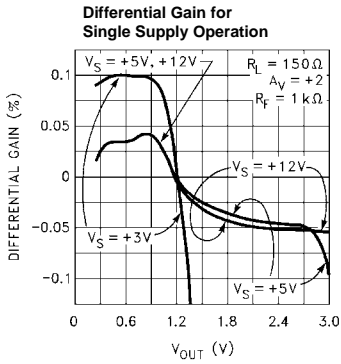

Typical Performance Curves (Continued)

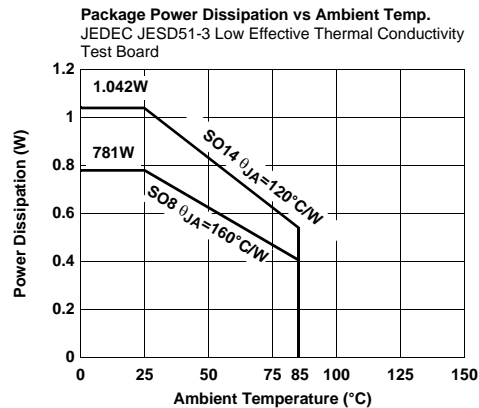
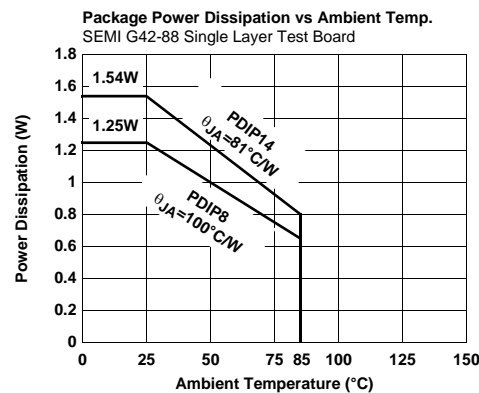
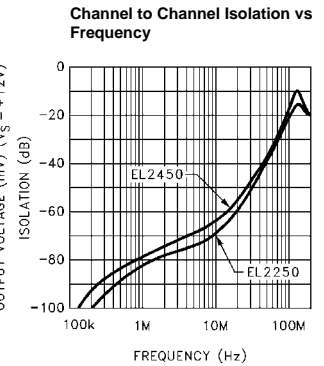
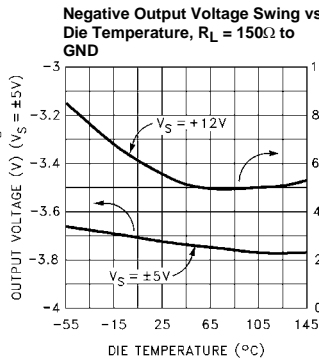
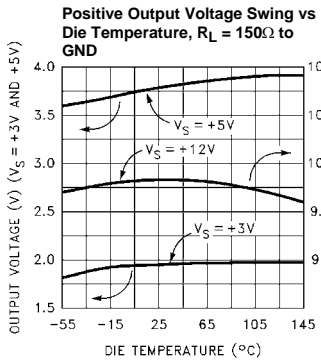
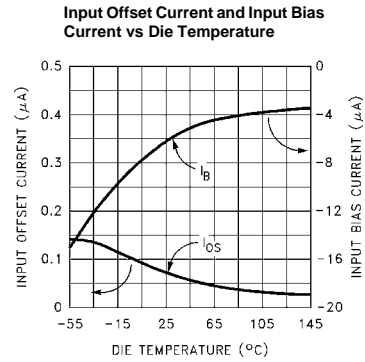
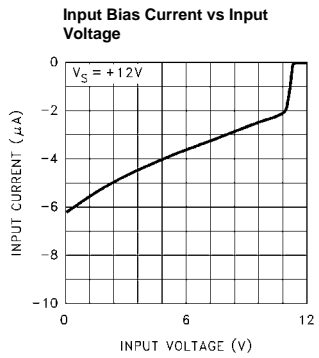
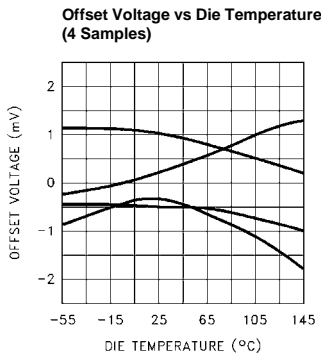
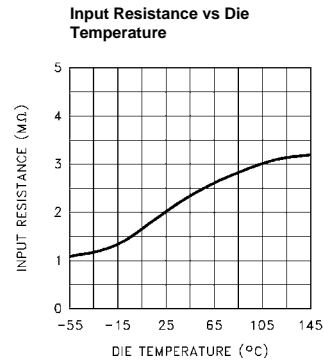
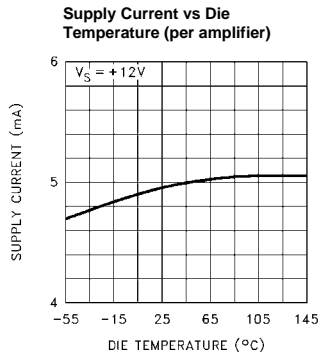
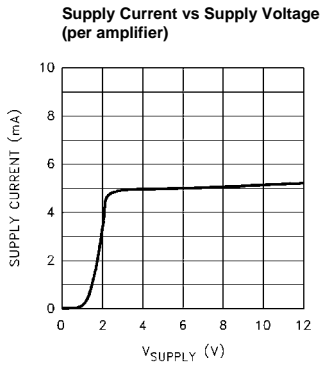

Simplified Schematic

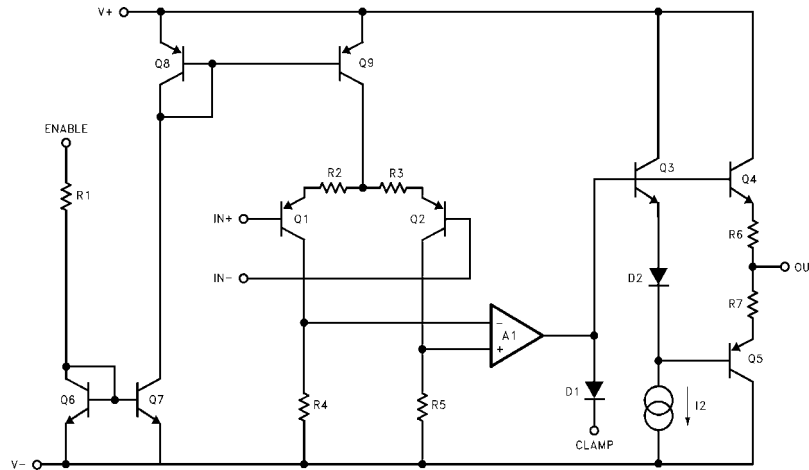

Applications Information

Product Description

The EL2250/EL2450 are part of a family of the industries fastest single supply operational amplifiers. Connected in voltage follower mode, their -3dB bandwidth is 125MHz while maintaining a 275V/ μ s slew rate. With an input and output common mode range that includes ground, these amplifiers were optimized for single supply operation, but will also accept dual supplies. They operate on a total supply voltage range as low as +2.7V or up to +12V. This makes them ideal for +3V applications, especially portable computers.

While many amplifiers claim to operate on a single supply, and some can sense ground at their inputs, most fail to truly drive their outputs to ground. If they do succeed in driving to ground, the amplifier often saturates, causing distortion and recovery delays. However, special circuitry built into the EL2250/EL2450 allows the output to follow the input signal to ground without recovery delays.

Power Supply Bypassing And Printed Circuit Board Layout

As with any high-frequency device, good printed circuit board layout is necessary for optimum performance. Ground plane construction is highly recommended. Lead lengths should be as short as possible. The power supply pins must be well bypassed to reduce the risk of oscillation. The combination of a 4.7 μ F tantalum capacitor in parallel with a 0.1 μ F ceramic capacitor has been shown to work well when placed at each supply pin. For single supply operation, where the GND pin is connected to the ground plane, a single 4.7 μ F tantalum capacitor in parallel with a 0.1 μ F ceramic capacitor across the V_{S+} and GND pins will suffice.

For good AC performance, parasitic capacitance should be kept to a minimum. Ground plane construction should be

used. Carbon or Metal-Film resistors are acceptable with the Metal-Film resistors giving slightly less peaking and bandwidth because of their additional series inductance. Use of sockets, particularly for the SO package should be avoided if possible. Sockets add parasitic inductance and capacitance which will result in some additional peaking and overshoot.

Supply Voltage Range and Single-Supply Operation

The EL2250/EL2450 have been designed to operate with supply voltages having a span of greater than 2.7V, and less than 12V. In practical terms, this means that the EL2250/EL2450 will operate on dual supplies ranging from ± 1.35 V to ± 6 V. With a single-supply, the EL2250/EL2450 will operate from +2.7V to +12V. Performance has been optimized for a single +5V supply.

Pins 8 and 4 are the power supply pins on the EL2250. The positive power supply is connected to pin 8. When used in single supply mode, pin 4 is connected to ground. When used in dual supply mode, the negative power supply is connected to pin 4.

Pins 4 and 11 are the power supply pins on the EL2450. The positive power supply is connected to pin 4. When used in single supply mode, pin 11 is connected to ground. When used in dual supply mode, the negative power supply is connected to pin 11.

As supply voltages continue to decrease, it becomes necessary to provide input and output voltage ranges that can get as close as possible to the supply voltages. The EL2250/EL2450 have an input voltage range that includes the negative supply and extends to within 1.2V of the positive supply. So, for example, on a single +5V supply, the EL2250/EL2450 have an input range which spans from 0V to 3.8V.

The output range of the EL2250/EL2450 is also quite large. It includes the negative rail, and extends to within 1V of the top supply rail with a 1k Ω load. On a +5V supply, the output is therefore capable of swinging from 0V to +4V. On split supplies, the output will swing ± 4 V. If the load resistor is tied to the negative rail and split supplies are used, the output range is extended to the negative rail.

Choice Of Feedback Resistor, R_F

The feedback resistor forms a pole with the input capacitance. As this pole becomes larger, phase margin is reduced. This increases ringing in the time domain and peaking in the frequency domain. Therefore, R_F has some maximum value which should not be exceeded for optimum performance. If a large value of R_F must be used, a small capacitor in the few picofarad range in parallel with R_F can help to reduce this ringing and peaking at the expense of reducing the bandwidth.

As far as the output stage of the amplifier is concerned, $R_F + R_G$ appear in parallel with R_L for gains other than +1. As this combination gets smaller, the bandwidth falls off. Consequently, R_F has a minimum value that should not be exceeded for optimum performance.

For $A_V = +1$, $R_F = 0\Omega$ is optimum. For $A_V = -1$ or +2 (noise gain of 2), optimum response is obtained with R_F between 500 Ω and 1k Ω . For $A_V = -4$ or +5 (noise gain of 5), keep R_F between 2k Ω and 10k Ω .

Video Performance

For good video performance, an amplifier is required to maintain the same output impedance and the same frequency response as DC levels are changed at the output. This can be difficult when driving a standard video load of 150 Ω , because of the change in output current with DC level. Differential Gain and Differential Phase for the EL2250/EL2450 are specified with the black level of the output video signal set to +1.2V. This allows ample room for the sync pulse even in a gain of +2 configuration. This results in dG and dP specifications of 0.05% and 0.05 $^\circ$ while driving 150 Ω at a gain of +2. Setting the black level to other values, although acceptable, will compromise peak performance. For example, looking at the single supply dG and dP curves for $R_L = 150\Omega$, if the output black level clamp is reduced from 1.2V to 0.6V dG/dP will increase from 0.05%/0.05 $^\circ$ to 0.08%/0.25 $^\circ$. Note that in a gain of +2 configuration, this is the lowest black level allowed such that the sync tip doesn't go below 0V.

If your application requires that the output goes to ground, then the output stage of the EL2250/EL2450, like all other single supply op amps, requires an external pull down resistor tied to ground. As mentioned above, the current flowing through this resistor becomes the DC bias current for the output stage NPN transistor. As this current approaches zero, the NPN turns off, and dG and dP will increase. This becomes more critical as the load resistor is increased in

value. While driving a light load, such as 1k Ω , if the input black level is kept above 1.25V, dG and dP are a respectable 0.03% and 0.03 $^\circ$.

For other biasing conditions see the Differential Gain and Differential Phase vs. Input Voltage curves.

Output Drive Capability

In spite of their moderately low 5mA of supply current, the EL2250/EL2450 are capable of providing ± 100 mA of output current into a 10 Ω load, or ± 60 mA into 50 Ω . With this large output current capability, a 50 Ω load can be driven to ± 3 V with $V_S = \pm 5$ V, making it an excellent choice for driving isolation transformers in telecommunications applications.

Driving Cables and Capacitive Loads

When used as a cable driver, double termination is always recommended for reflection-free performance. For those applications, the back-termination series resistor will decouple the EL2250/EL2450 from the cable and allow extensive capacitive drive. However, other applications may have high capacitive loads without a back-termination resistor. In these applications, a small series resistor (usually between 5 Ω and 50 Ω) can be placed in series with the output to eliminate most peaking. The gain resistor (R_G) can then be chosen to make up for any gain loss which may be created by this additional resistor at the output.

Video Sync Pulse Remover Application

All CMOS Analog to Digital Converters (A/Ds) have a parasitic latch-up problem when subjected to negative input voltage levels. Since the sync tip contains no useful video information and it is a negative going pulse, we can chop it off.

Figure 1 shows a unity gain connected amplifier A of an EL2250. Figure 2 shows the complete input video signal applied at the input, as well as the output signal with the negative going sync pulse removed.

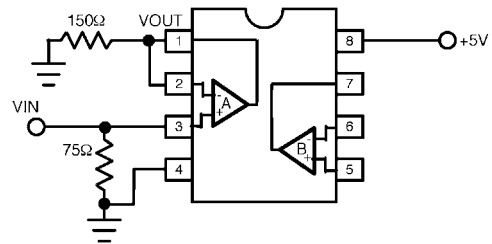

FIGURE 1.

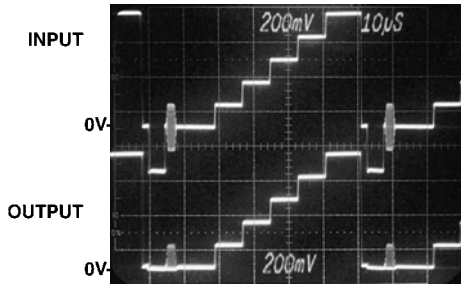

FIGURE 2.

Short Circuit Current Limit

The EL2250/EL2450 have internal short circuit protection circuitry that protect it in the event of its output being shorted to either supply rail. This limit is set to around 100mA nominally and reduces with increasing junction temperature. It is intended to handle temporary shorts. If an output is shorted indefinitely, the power dissipation could easily increase such that the part will be destroyed. Maximum reliability is maintained if the output current never exceeds ±90mA. A heat sink may be required to keep the junction temperature below absolute maximum when an output is shorted indefinitely.

Power Dissipation

With the high output drive capability of the EL2250/EL2450, it is possible to exceed the 150°C Absolute Maximum junction temperature under certain load current conditions. Therefore, it is important to calculate the maximum junction temperature for the application to determine if power-supply voltages, load conditions, or package type need to be modified for the EL2250/EL2450 to remain in the safe operating area.

The maximum power dissipation allowed in a package is determined according to [1]:

$$PD_{MAX} = \frac{T_{JMAX} - T_{AMAX}}{\theta_{JA}}$$

where:

T_{JMAX} = Maximum Junction Temperature

T_{AMAX} = Maximum Ambient Temperature

θ_{JA} = Thermal Resistance of the Package

PD_{MAX} = Maximum Power Dissipation in the Package.

The maximum power dissipation actually produced by an IC is the total quiescent supply current times the total power supply voltage, plus the power in the IC due to the load, or [2]:

$$PD_{MAX} = N \times \left(V_S \times I_{SMAX} + (V_S - V_{OUT}) \times \frac{V_{OUT}}{R_L} \right)$$

where:

N = Number of amplifiers

V_S = Total Supply Voltage

I_{SMAX} = Maximum Supply Current per amplifier

V_{OUT} = Maximum Output Voltage of the Application

R_L = Load Resistance tied to Ground

If we set the two PD_{MAX} equations, [1] & [2], equal to each other, and solve for V_S , we can get a family of curves for various loads and output voltages according to [3]:

$$V_S = \frac{\frac{R_L \times (T_{JMAX} - T_{AMAX})}{N \times \theta_{JA}} + (V_{OUT})}{(I_S \times R_L) + V_{OUT}}$$

Figures 3 through 6 below show total single supply voltage V_S vs. R_L for various output voltage swings for the PDIP and SO packages. The curves assume WORST CASE conditions of $T_A = +85^\circ\text{C}$ and $I_S = 6.5\text{mA}$ per amplifier.

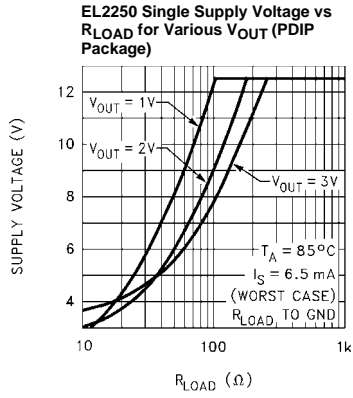

FIGURE 3.

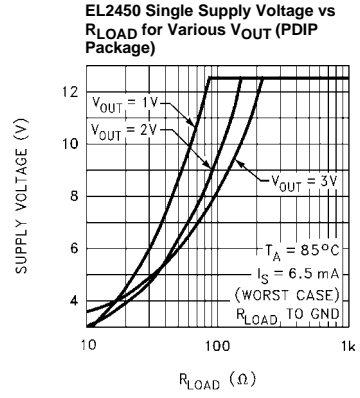

FIGURE 5.

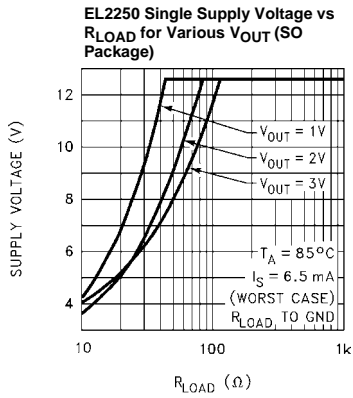

FIGURE 4.

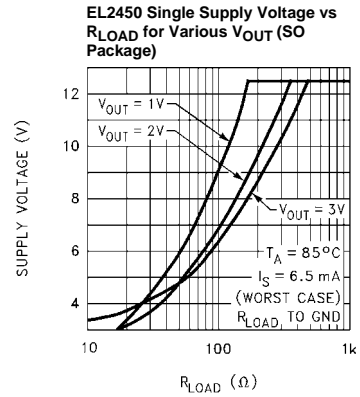

FIGURE 6.

EL2250/EL2450 Macromodel (one amplifier)

* Revision A, April 1996
 * Pin numbers reflect a standard single op amp.

* Connections:

	+input				
*		-input			
*			+Vsupply		
*			-Vsupply		
*				output	
.subckt EL2250/el	3	2	7	4	6

* Input Stage

*
 i1 7 10 250µA
 i2 7 11 250µA
 r1 10 11 4k
 q1 12 2 10 qp
 q2 13 3 11 qpa
 r2 12 4 100
 r3 13 4 100
 *

* Second Stage & Compensation

*
 gm 15 4 13 12 4.6m
 r4 15 4 15Meg
 c1 15 4 0.36pF
 *

* Poles

*
 e1 17 4 15 4 1.0
 r6 17 25 400
 c3 25 4 1pF
 r7 25 18 500
 c4 18 4 1pF
 *

* Output Stage

*
 i3 20 4 1.0mA
 q3 7 23 20 qn
 q4 7 18 19 qn
 q5 7 18 21 qn
 q6 4 20 22 qp
 q7 7 23 18 qn
 d1 19 20 da
 r8 21 6 2
 r9 22 6 2
 r10 18 21 10k
 r11 7 23 100k
 d2 23 24 da
 d3 24 4 da
 d4 23 18 da
 *

* Power Supply Current

*
 ips 7 4 3.2mA
 *

* Models

*
 .model qn npn(is=800e-18 bf=150 tf=0.02nS)
 .model qpa pnp(is=810e-18 bf=50 tf=0.02nS)
 .model qp pnp(is=800e-18 bf=54 tf=0.02nS)
 .model da d(tt=0nS)
 .ends

EL2250/EL2450 Macromodel (one amplifier)

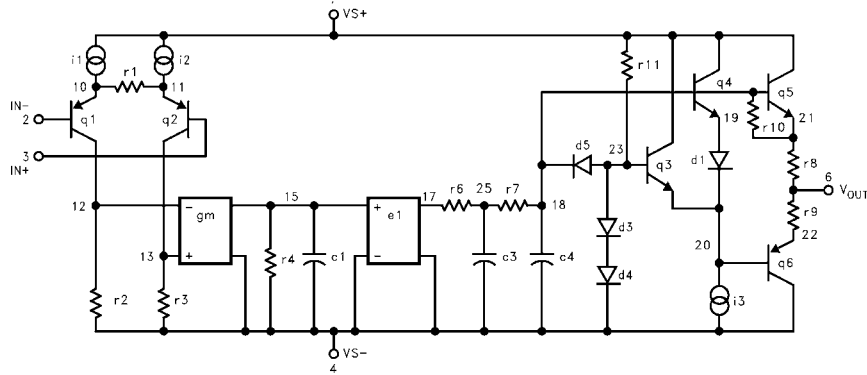

All Intersil U.S. products are manufactured, assembled and tested utilizing ISO9000 quality systems.
Intersil Corporation's quality certifications can be viewed at www.intersil.com/design/quality

Intersil products are sold by description only. Intersil Corporation reserves the right to make changes in circuit design, software and/or specifications at any time without notice. Accordingly, the reader is cautioned to verify that data sheets are current before placing orders. Information furnished by Intersil is believed to be accurate and reliable. However, no responsibility is assumed by Intersil or its subsidiaries for its use; nor for any infringements of patents or other rights of third parties which may result from its use. No license is granted by implication or otherwise under any patent or patent rights of Intersil or its subsidiaries.

For information regarding Intersil Corporation and its products, see www.intersil.com