

300MHz Amplifiers

The EL5152, EL5153, EL5252, and EL5455 are 300MHz bandwidth -3dB voltage mode feedback amplifiers with DC accuracy of < 0.01%, 1mV offsets and 50kV/V open loop gains. These amplifiers are ideally suited for applications ranging from precision measurement instrumentation to high-speed video and monitor applications demanding higher linearity at higher frequency. Capable of operating with as little as 3.0mA of current from a single supply ranging from 5V to 12V dual supplies ranging from $\pm 2.5V$ to $\pm 5.0V$ these amplifiers are also well suited for handheld, portable and battery-powered equipment.

Single amplifiers are offered in SOT-23 packages and duals in a 10-pin MSOP package for applications where board space is critical. Quad amplifiers are available in a 14-pin SO package. Additionally, singles and duals are available in the industry-standard 8-pin SO. All parts operate over the industrial temperature range of $-40^{\circ}C$ to $+85^{\circ}C$.

Ordering Information

PART NUMBER	PACKAGE	TAPE & REEL	PKG. DWG. #
EL5152IS	8-Pin SO	-	MDP0027
EL5152IS-T7	8-Pin SO	7"	MDP0027
EL5152IS-T13	8-Pin SO	13"	MDP0027
EL5152ISZ (See Note)	8-Pin SO (Pb-free)	-	MDP0027
EL5152ISZ-T7 (See Note)	8-Pin SO (Pb-free)	7"	MDP0027
EL5152ISZ-T13 (See Note)	8-Pin SO (Pb-free)	13"	MDP0027
EL5153IW-T7	5-Pin SOT-23	7" (3K pcs)	MDP0038
EL5153IW-T7A	5-Pin SOT-23	7" (250 pcs)	MDP0038
EL5153IWZ-T7 (See Note)	5-Pin SOT-23 (Pb-free)	7" (3K pcs)	MDP0038
EL5153IWZ-T7A (See Note)	5-Pin SOT-23 (Pb-free)	7" (250 pcs)	MDP0038
EL5252IY	10-Pin MSOP	-	MDP0043
EL5252IY-T7	10-Pin MSOP	7"	MDP0043
EL5252IY-T13	10-Pin MSOP	13"	MDP0043
EL5455IS	14-Pin SO	-	MDP0027
EL5455IS-T7	14-Pin SO	7"	MDP0027
EL5455IS-T13	14-Pin SO	13"	MDP0027

NOTE: Intersil Pb-free products employ special Pb-free material sets; molding compounds/die attach materials and 100% matte tin plate termination finish, which are RoHS compliant and compatible with both SnPb and Pb-free soldering operations. Intersil Pb-free products are MSL classified at Pb-free peak reflow temperatures that meet or exceed the Pb-free requirements of IPC/JEDEC J STD-020.

Features

- 270MHz -3dB bandwidth
- 180V/ μs slew rate
- $\pm 1mV$ maximum V_{OS}
- Very high open loop gains 50kV/V
- Low supply current = 3mA
- 105mA output current
- Single supplies from 5V to 12V
- Dual supplies from $\pm 2.5V$ to $\pm 5V$
- Fast disable on the EL5152 and EL5252
- Low cost
- Pb-Free available (RoHS compliant)

Applications

- Imaging
- Instrumentation
- Video
- Communications devices

Pinouts

EL5152
(8-PIN SO)
TOP VIEW

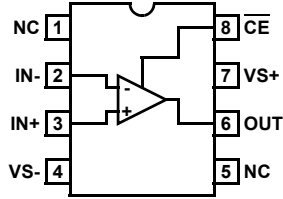

EL5153
(5-PIN SOT-23)
TOP VIEW

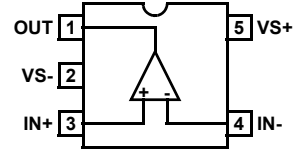

EL5252
(10-PIN MSOP)
TOP VIEW

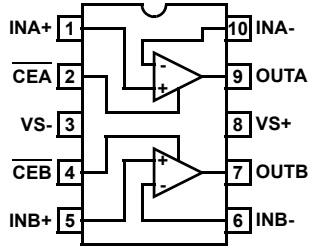

EL5455
(14-PIN SO)
TOP VIEW

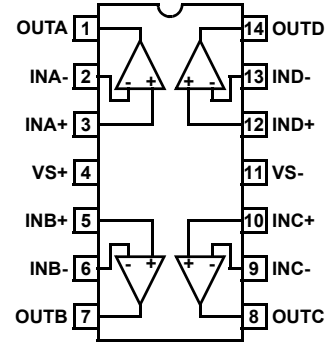

EL5152, EL5153, EL5252, EL5455

Absolute Maximum Ratings ($T_A = 25^\circ\text{C}$)

Supply Voltage between V_S and GND	13.2V	Junction Temperature	+125°C
Maximum Continuous Output Current	50mA	Storage Temperature	-65°C to +150°C
Pin Voltages	GND -0.5V to V_S +0.5V	Ambient Operating Temperature	-40°C to +85°C
Power Dissipation	See Curves	Current into I_{N+} , I_{N-} , CE	5mA

CAUTION: Stresses above those listed in "Absolute Maximum Ratings" may cause permanent damage to the device. This is a stress only rating and operation of the device at these or any other conditions above those indicated in the operational sections of this specification is not implied.

IMPORTANT NOTE: All parameters having Min/Max specifications are guaranteed. Typical values are for information purposes only. Unless otherwise noted, all tests are at the specified temperature and are pulsed tests, therefore: $T_J = T_C = T_A$

Electrical Specifications $V_{S+} = +5V$, $V_{S-} = \pm 5V$, $R_F = R_G = 750\Omega$, $R_L = 150\Omega$, $T_A = 25^\circ\text{C}$, unless otherwise specified.

PARAMETER	DESCRIPTION	CONDITIONS	MIN	TYP	MAX	UNIT
AC PERFORMANCE						
BW	-3dB Bandwidth	$A_V = +1$, $R_L = 500\Omega$, $C_L = 5.0\text{pF}$		300		MHz
		$A_V = +2$, $R_L = 150\Omega$		85		MHz
GBWP	Gain Bandwidth Product	$R_L = 150\Omega$		165		MHz
BW1	0.1dB Bandwidth	$A_V = +1$, $R_L = 500\Omega$		50		MHz
SR	Slew Rate	$V_O = -3V$ to $+3V$, $A_V = +2$	120	155		V/ μs
		$V_O = -3V$ to $+3V$, $A_V = 1$, $R_L = 500\Omega$		180		V/ μs
t_S	0.1% Settling Time	$V_{OUT} = -1V$ to $+1V$, $A_V = +2$		30		ns
dG	Differential Gain Error	$A_V = +2$, $R_L = 150\Omega$		0.06		%
dP	Differential Phase Error	$A_V = +2$, $R_L = 150\Omega$		0.045		°
V_N	Input Referred Voltage Noise			12		nV/ $\sqrt{\text{Hz}}$
I_N	Input Referred Current Noise			1.8		pA/ $\sqrt{\text{Hz}}$
DC PERFORMANCE						
V_{OS}	Offset Voltage		-1	0.5	1	mV
$T_C V_{OS}$	Input Offset Voltage Temperature Coefficient	Measured from T_{MIN} to T_{MAX}		-2		$\mu\text{V}/^\circ\text{C}$
A_{VOL}	Open Loop Gain	V_O is from -2.5V to 2.5V (EL5152 & EL5153)	10	20		kV/V
		V_O is from -2.5V to 2.5V (EL5252 & EL5455)	15	50		kV/V
INPUT CHARACTERISTICS						
CMIR	Common Mode Input Range	Guaranteed by CMRR test	-2.5		2.5	V
CMRR	Common Mode Rejection Ratio	$V_{CM} = 2.5$ to -2.5	85	110		dB
I_B	Bias Current		-0.4	0.12	+0.6	μA
I_{OS}	Input Offset Current		-80	12	80	nA
R_{IN}	Input Resistance		25	60		M Ω
C_{IN}	Input Capacitance			1		pF
OUTPUT CHARACTERISTICS						
V_{OUT}	Output Voltage Swing	$R_L = 150\Omega$ to GND	± 3.0	± 3.3		V
		$R_L = 500\Omega$ to GND	± 3.4	± 3.7		V
I_{OUT}	Output Current	$R_L = 10\Omega$ to GND	60	105		mA
ENABLE (SELECTED PACKAGES ONLY)						
t_{EN}	Enable Time			200		ns
t_{DIS}	Disable Time			300		ns

EL5152, EL5153, EL5252, EL5455

Electrical Specifications

$V_{S+} = +5V$, $V_{S-} = \pm 5V$, $R_F = R_G = 750\Omega$, $R_L = 150\Omega$, $T_A = 25^\circ C$, unless otherwise specified. **(Continued)**

PARAMETER	DESCRIPTION	CONDITIONS	MIN	TYP	MAX	UNIT
I_{IHCE}	\overline{CE} Pin Input High Current	$\overline{CE} = V_{S+}$		0	-1	μA
I_{ILCE}	\overline{CE} Pin Input Low Current	$\overline{CE} = V_{S-}$	5	13	25	μA
V_{IHCE}	\overline{CE} Input High Voltage for Power-down		$V_{S+} - 1$			V
V_{ILCE}	\overline{CE} Input Low Voltage for Power-up				$V_{S+} - 3$	V
SUPPLY						
I_{SON}	Supply Current - Enabled (per amplifier)	No load, $V_{IN} = 0V$, $\overline{CE} = +5V$	2.46	3.0	3.43	mA
I_{SOFF}	Supply Current - Disabled (per amplifier)	No load, $V_{IN} = 0V$, $\overline{CE} = 5V$	5	13	25	μA
PSRR	Power Supply Rejection Ratio	DC, $V_S = \pm 3.0V$ to $\pm 6.0V$ (EL5152 & EL5153)	85	116		dB
		DC, $V_S = \pm 3.0V$ to $\pm 6.0V$ (EL5252 & EL5455)	80	95		dB

Typical Performance Curves

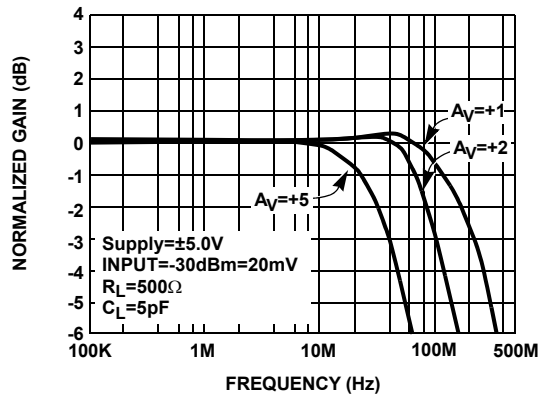

FIGURE 1. EL5152 SMALL SIGNAL FREQUENCY FOR VARIOUS GAINS

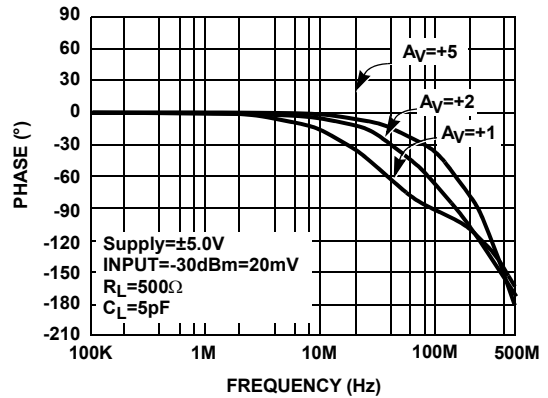

FIGURE 2. EL5152 SMALL SIGNAL FREQUENCY PHASE FOR VARIOUS GAINS

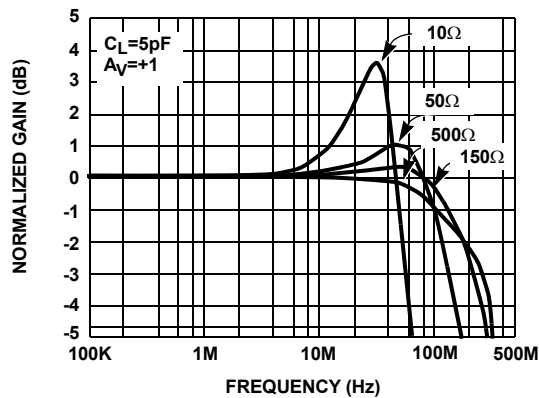

FIGURE 3. FREQUENCY RESPONSE FOR VARIOUS R_L

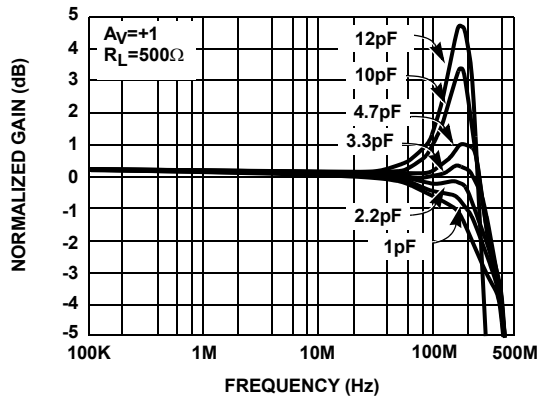

FIGURE 4. FREQUENCY RESPONSE FOR VARIOUS C_L

Typical Performance Curves (Continued)

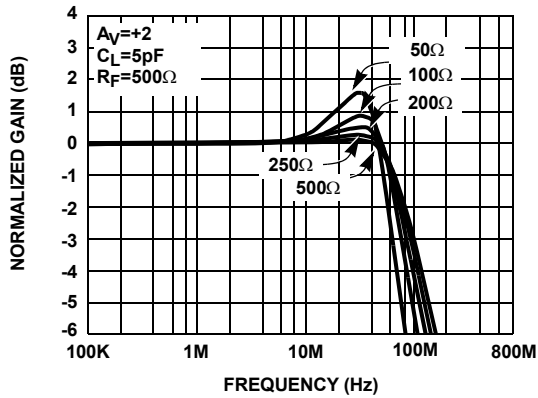

FIGURE 5. FREQUENCY RESPONSE FOR VARIOUS R_L

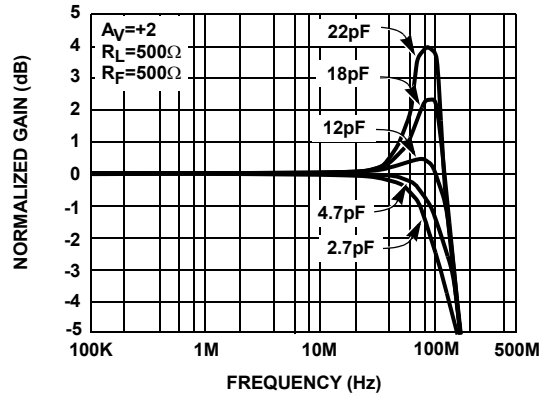

FIGURE 6. FREQUENCY RESPONSE FOR VARIOUS C_L

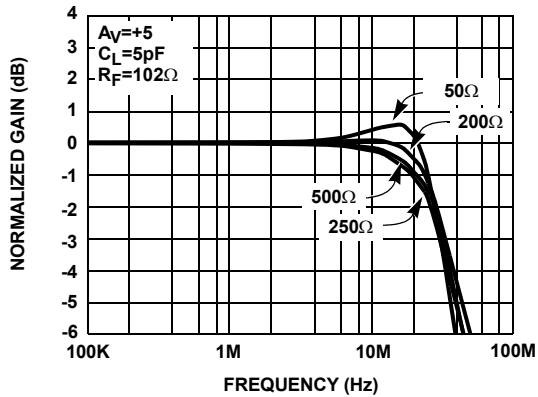

FIGURE 7. FREQUENCY RESPONSE FOR VARIOUS R_L

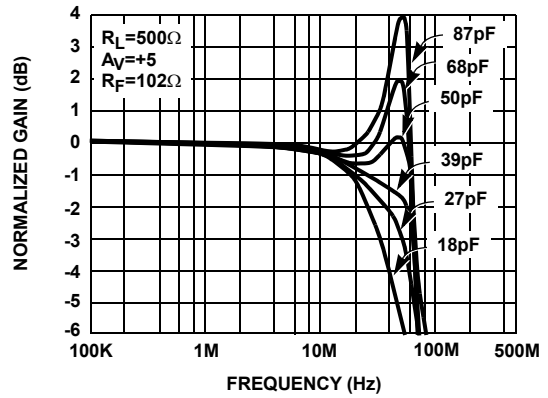

FIGURE 8. FREQUENCY RESPONSE FOR VARIOUS C_L

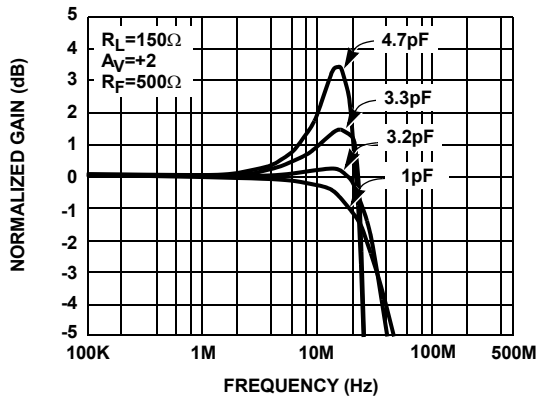

FIGURE 9. FREQUENCY RESPONSE FOR VARIOUS C_{IN}

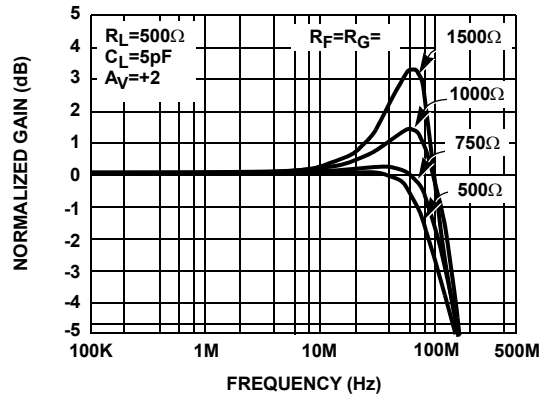

FIGURE 10. FREQUENCY RESPONSE vs R_F/R_G

Typical Performance Curves (Continued)

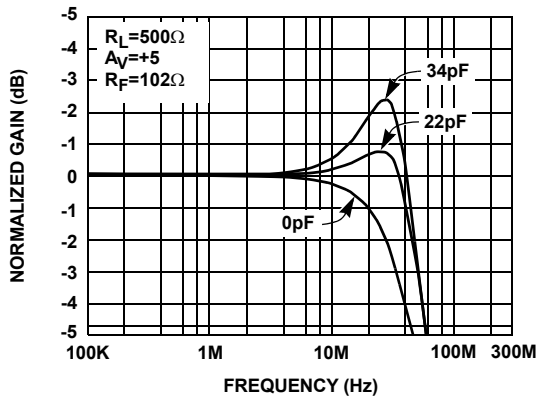

FIGURE 11. FREQUENCY RESPONSE FOR VARIOUS C_{IN}

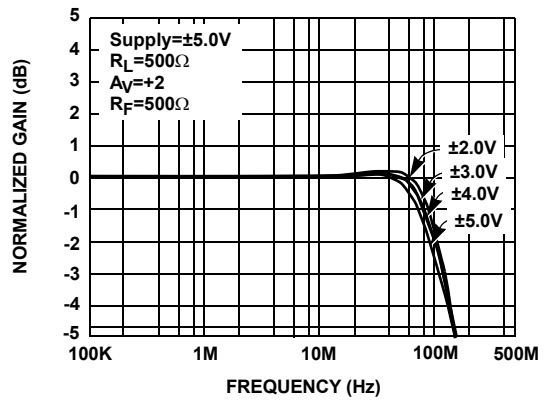

FIGURE 12. FREQUENCY RESPONSE FOR VARIOUS POWER SUPPLY

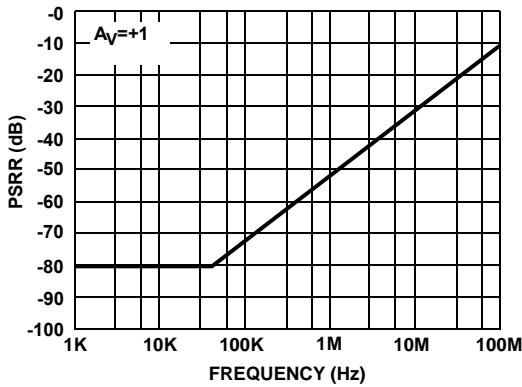

FIGURE 13. PSRR

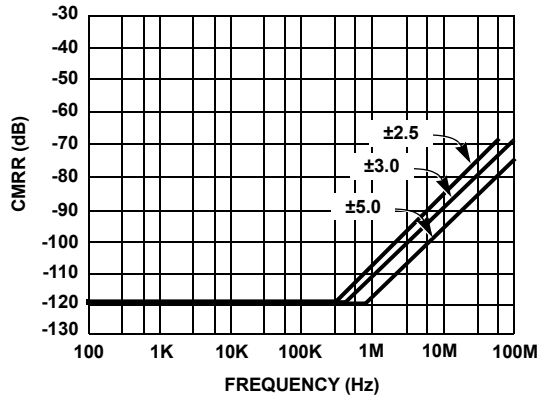

FIGURE 14. CMRR FOR VARIOUS POWER SUPPLY VALUES

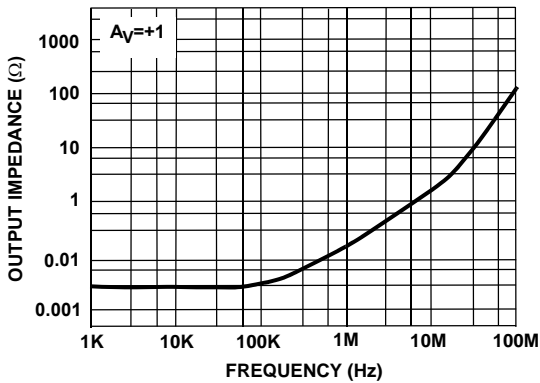

FIGURE 15. OUTPUT IMPEDANCE

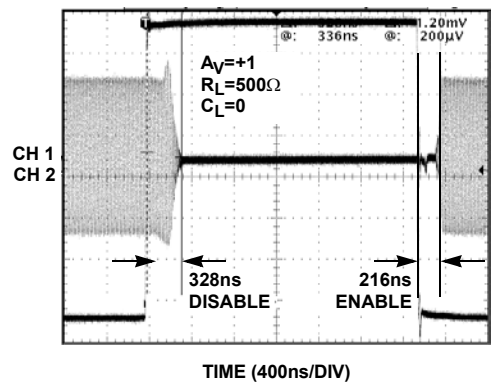

FIGURE 16. ENABLE/DISABLE RESPONSE

Typical Performance Curves (Continued)

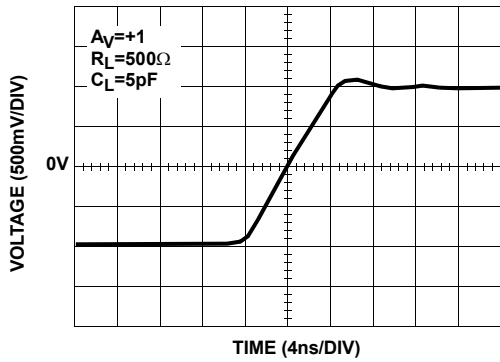

FIGURE 17. RISE TIME - LARGE SIGNAL RESPONSE

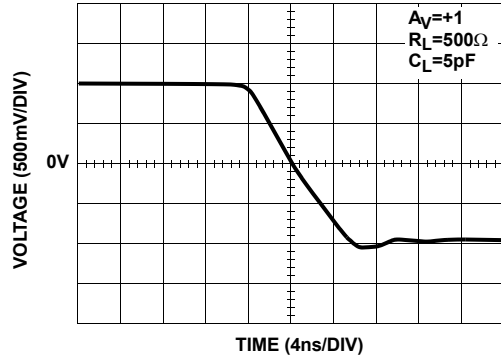

FIGURE 18. FALL TIME - LARGE SIGNAL RESPONSE

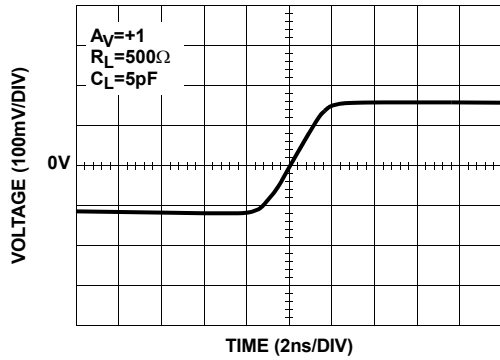

FIGURE 19. RISE TIME - SMALL SIGNAL RESPONSE

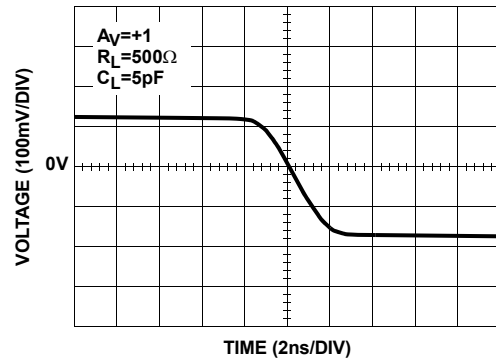

FIGURE 20. FALL TIME - SMALL SIGNAL RESPONSE

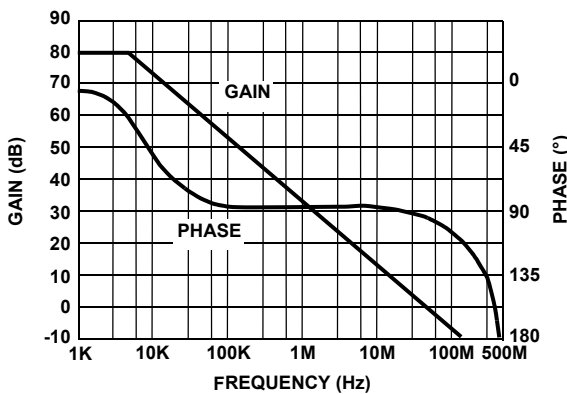

FIGURE 21. EL5152 SMALL SIGNAL OPEN LOOP GAIN vs FREQUENCY INVERTING

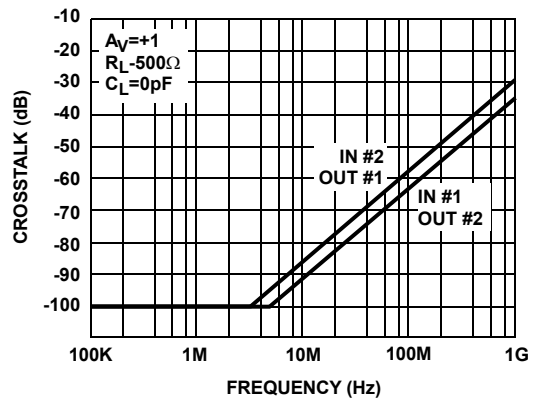

FIGURE 22. EL5252 SMALL SIGNAL FREQUENCY vs CROSSTALK

Typical Performance Curves (Continued)

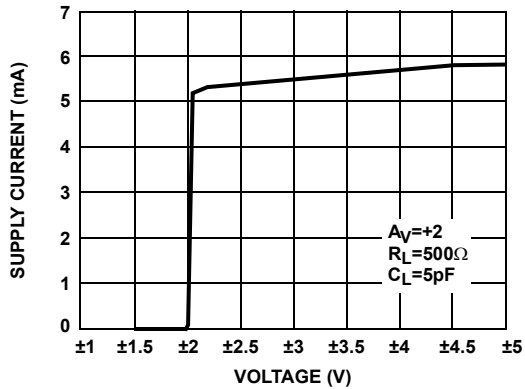

FIGURE 23. SUPPLY CURRENT vs SUPPLY VOLTAGE

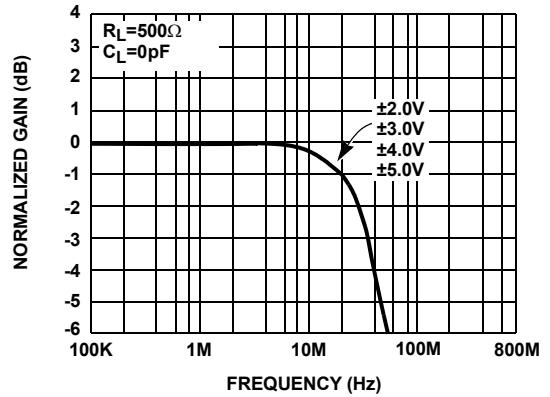

FIGURE 24. FREQUENCY RESPONSE FOR VARIOUS VOLTAGE SUPPLY LEVELS

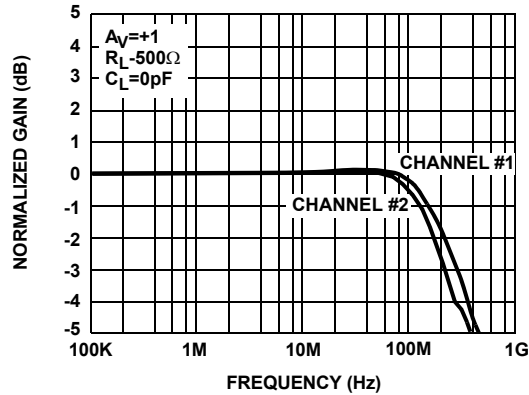

FIGURE 25. EL5252 SMALL SIGNAL FREQUENCY - CHANNEL TO CHANNEL

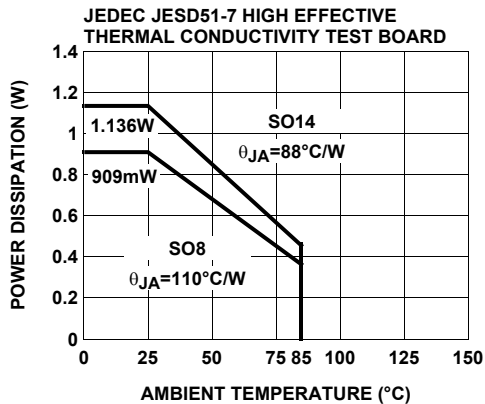

FIGURE 26. PACKAGE POWER DISSIPATION vs AMBIENT TEMPERATURE

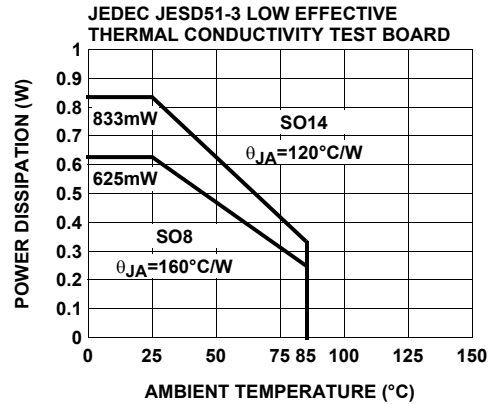

FIGURE 27. PACKAGE POWER DISSIPATION vs AMBIENT TEMPERATURE

Typical Performance Curves (Continued)

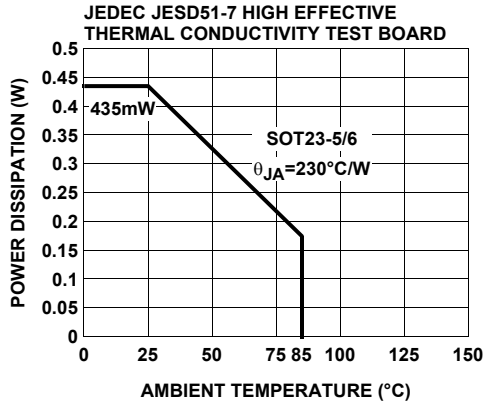

FIGURE 28. PACKAGE POWER DISSIPATION vs AMBIENT TEMPERATURE

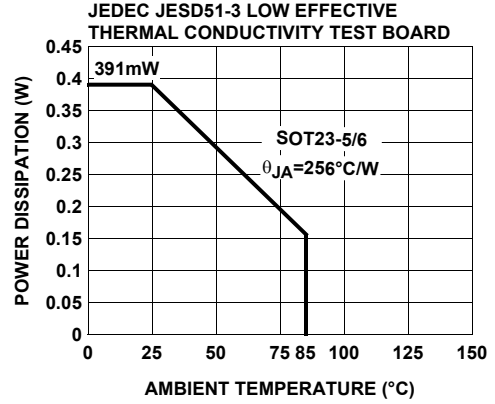

FIGURE 29. PACKAGE POWER DISSIPATION vs AMBIENT TEMPERATURE

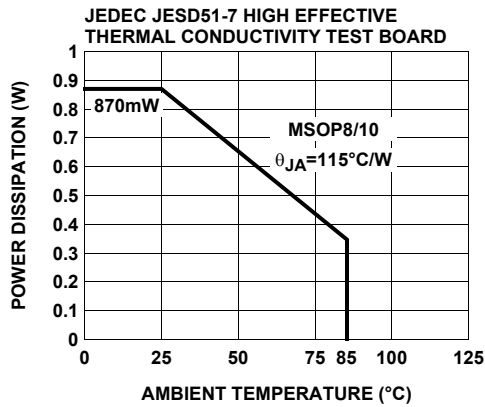

FIGURE 30. PACKAGE POWER DISSIPATION vs AMBIENT TEMPERATURE

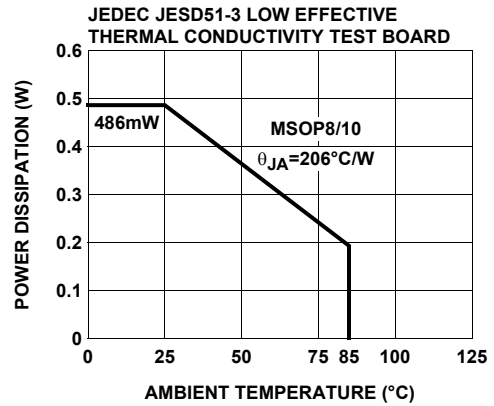

FIGURE 31. PACKAGE POWER DISSIPATION vs AMBIENT TEMPERATURE

EL5152 Product Description

The EL5152, EL5153, EL5252, and EL5253 are wide bandwidth, low power, low offset voltage feedback operational amplifiers capable of operating from a single or dual power supplies. This family of operational amplifiers are internally compensated for closed loop gain of +1 or greater. Connected in voltage follower mode, driving a 500W load members of this amplifier family demonstrate a -3dB bandwidth of about 300MHz. With the loading set to accommodate typical video application, 150Ω load and gain set to +2, bandwidth reduces to about 180MHz with a 600V/μs slew rate. Power down pins on the EL5152 and EL5252 reduce the already low power demands of this amplifier family to 17μA typical while the amplifier is disabled.

Input, Output and Supply Voltage Range

The EL5152 and EL5153 families have been designed to operate with supply voltage ranging from 5V to 12V. Supply voltages range from ±2.5V to ±5V for split supply operation. Of course split supply operation can easily be achieved using single supplies by splitting off half of the single supply with a simple voltage divider as illustrated in the application circuit section.

Input Common Mode Range

These amplifiers have an input common mode voltage ranging from 1.5V above the negative supply (V_{S-} pin) to 1.5V below the positive supply (V_{S+} pin). If the input signal is driven beyond this range the output signal will exhibit distortion.

Maximum Output Swing & Load Resistance

The outputs of the EL5152 and EL5153 families maximum output swing ranges from -4V to 4V for $V_{S} = \pm 5V$ with a load resistance of 500Ω. Naturally, as the load resistance becomes lower, the output swing lowers accordingly; for instance, if the load resistor is 150Ω, the output swing ranges from -3.5V to 3.5V. This response is a simple application of Ohms law indicating a lower value resistance results in greater current demands of the amplifier. Additionally, the load resistance affects the frequency response of this family as well as all operational amplifiers, as clearly indicated by the Gain Vs Frequency For Various RL curves clearly indicate. In the case of the frequency response reduced bandwidth with decreasing load resistance is a function of load resistance in conjunction with the output zero response of the amplifier.

Choosing A Feedback Resistor

A feedback resistor is required to achieve unity gain; simply short the output pin to the inverting input pin. Gains greater than +1 require a feedback and gain resistor to set the desired gain. This gets interesting because the feedback resistor forms a pole with the parasitic capacitance at the inverting input. As the feedback resistance increases the

position of the pole shifts in the frequency domain, the amplifier's phase margin is reduced and the amplifier becomes less stable. Peaking in the frequency domain and ringing in the time domain are symptomatic of this shift in pole location. So we want to keep the feedback resistor as small as possible. You may want to use a large feedback resistor for some reason; in this case to compensate the shift of the pole and maintain stability a small capacitor in the few Pico farad range in parallel with the feedback resistor is recommended.

For the gains greater than unity, it has been determined a feedback resistance ranging from 500Ω to 750Ω provides optimal response.

Gain Bandwidth Product

The EL5156 and EL5157 families have a gain bandwidth product of 210MHz for a gain of +5. Bandwidth can be predicted by the following equation:

$$(\text{Gain}) \times (\text{BW}) = \text{GainBandwidthProduct}$$

Video Performance

For good video performance, an amplifier is required to maintain the same output impedance and same frequency response as DC levels are changed at the output; this characteristic is widely referred to as "diffgain-diffphase". Many amplifiers have a difficult time with this especially while driving standard video loads of 150Ω, as the output current has a natural tendency to change with DC level. The EL5152 dG and dP for these families is a respectable 0.006% and 0.04%, while driving 150Ω at a gain of 2. Driving high impedance loads would give a similar or better dG and dP performance as the current output demands placed on the amplifier lessen with increased load.

Driving Capacitive Loads

The EL5152 and EL5153 families can easily drive capacitive loads as demanding as 27pF in parallel with 500Ω while holding peaking to within 5dB of peaking at unity gain. Of course if less peaking is desired, a small series resistor (usually between 5Ω to 50Ω) can be placed in series with the output to eliminate most peaking. However, there will be a small sacrifice of gain which can be recovered by simply adjusting the value of the gain resistor.

Driving Cables

Both ends of all cables must always be properly terminated; double termination is absolutely necessary for reflection-free performance. Additionally, a back-termination series resistor at the amplifier's output will isolate the amplifier from the cable and allow extensive capacitive drive. However, other applications may have high capacitive loads without a back-termination resistor. Again, a small series resistor at the output can help to reduce peaking.

Disable/Power-Down

The EL5152 and EL5253 can be disabled with their output placed in a high impedance state. The turn off time is about 330ns and the turn on time is about 130ns. When disabled, the amplifier's supply current is reduced to 17µA typically; essentially eliminating power consumption. The amplifier's power down is controlled by standard TTL or CMOS signal levels at the ENABLE pin. The applied logic signal is relative to V_{S-} pin. Letting the ENABLE pin float or the application of a signal that is less than 0.8V above V_{S-} enables the amplifier. The amplifier is disabled when the signal at ENABLE pin is above V_{S+} -1.5V.

Output Drive Capability

The EL5152 and EL5153 families do not have internal short circuit protection circuitry. Typically, short circuit currents as high as 95mA and 70mA can be expected and naturally, if the output is shorted indefinitely the part can easily be damaged from overheating, or excessive current density may eventually compromise metal integrity. Maximum reliability is maintained if the output current is always held below ±40mA. This limit is set and limited by the design of the internal metal interconnect. Note that in transient applications, the part is extremely robust.

Power Dissipation

With the high output drive capability of the EL5152 and EL5153 families, it is possible to exceed the 125°C absolute maximum junction temperature under certain load current conditions. Therefore, it is important to calculate the maximum junction temperature for an application to determine if load conditions or package types need to be modified to assure operation of the amplifier in a safe operating area.

The maximum power dissipation allowed in a package is determined according to:

$$PD_{MAX} = \frac{T_{JMAX} - T_{AMAX}}{\Theta_{JA}}$$

Where:

T_{JMAX} = Maximum junction temperature

T_{AMAX} = Maximum ambient temperature

q_{JA} = Thermal resistance of the package

The maximum power dissipation actually produced by an IC is the total quiescent supply current times the total power supply voltage, plus the power in the IC due to the load, or:

For sourcing:

$$PD_{MAX} = V_S \times I_{SMAX} + \sum_{i=1}^n (V_S - V_{OUTi}) \times \frac{V_{OUTi}}{R_{Li}}$$

For sinking:

$$PD_{MAX} = V_S \times I_{SMAX} + \sum_{i=1}^n (V_{OUTi} - V_S) \times I_{LOADi}$$

Where:

V_S = Supply voltage

I_{SMAX} = Maximum quiescent supply current

V_{OUT} = Maximum output voltage of the application

R_{LOAD} = Load resistance tied to ground

I_{LOAD} = Load current

N = number of amplifiers (Max = 2)

By setting the two PD_{MAX} equations equal to each other, we can solve the output current and R_{LOAD} to avoid the device overheat.

Power Supply Bypassing Printed Circuit Board Layout

As with any high frequency device, a good printed circuit board layout is necessary for optimum performance. Lead lengths should be as short as possible. The power supply pin must be well bypassed to reduce the risk of oscillation. For normal single supply operation, where the V_{S-} pin is connected to the ground plane, a single 4.7µF tantalum capacitor in parallel with a 0.1µF ceramic capacitor from V_{S+} to GND will suffice. This same capacitor combination should be placed at each supply pin to ground if split supplies are to be used. In this case, the V_{S-} pin becomes the negative supply rail. See Figure 1 for a complete tuned power supply bypass methodology.

Printed Circuit Board Layout

For good AC performance, parasitic capacitance should be kept to minimum. Use of wire wound resistors should be avoided because of their additional series inductance. Use of sockets should also be avoided if possible. Sockets add parasitic inductance and capacitance that can result in compromised performance. Minimizing parasitic capacitance at the amplifier's inverting input pin is very important. The feedback resistor should be placed very close to the inverting input pin. Strip line design techniques are recommended for the signal traces.

Application Circuits

Sallen Key Low Pass Filter

A common and easy to implement filter taking advantage of the wide bandwidth, low offset and low power demands of the EL5152. A derivation of the transfer function is provided for convenience. (See Figure 32)

Sallen Key High Pass Filter

Again this useful filter benefits from the characteristics of the EL5152. The transfer function is very similar to the low pass so only the results are presented. (See Figure 33)

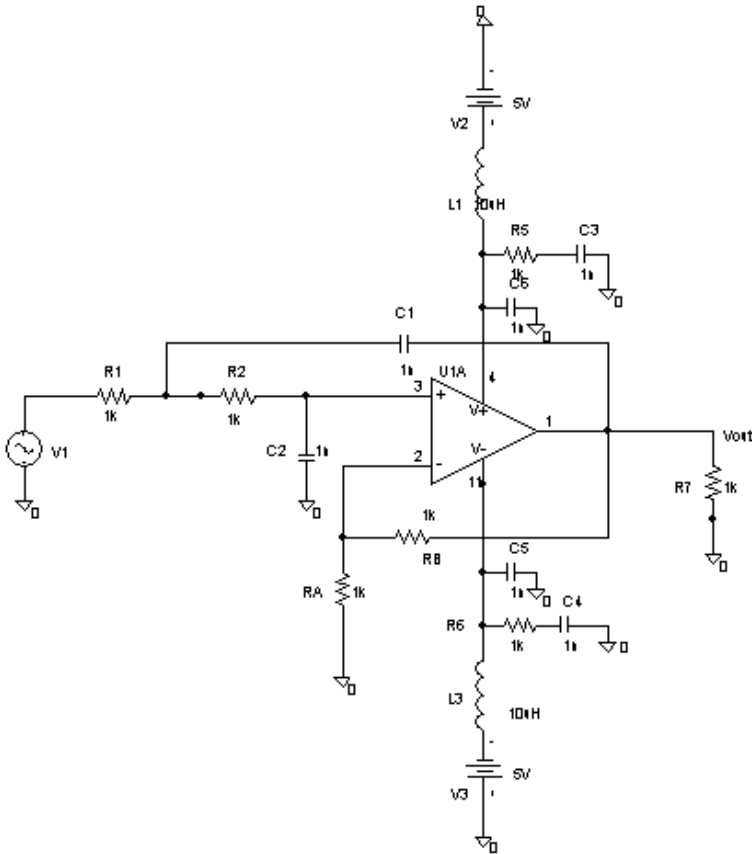

$$K = 1 + \frac{R_B}{R_A}$$

$$V_o = K \frac{1}{R_2 C_2 s + 1} V_1$$

$$\frac{V_1 - V_i}{R_1} + \frac{K - V_1}{R_2} + \frac{V_o - V_i}{\frac{1}{C_1 s}} = 0$$

$$H(s) = \frac{K}{R_1 C_1 R_2 C_2 s^2 + ((1 - K)R_1 C_1 + R_1 C_2 + R_2 C_2)s + 1}$$

$$H(j\omega) = \frac{1}{1 - \omega^2 R_1 C_1 R_2 C_2 + j\omega((1 - K)R_1 C_1 + R_1 C_2 + R_2 C_2)}$$

$$H_{olp} = K$$

$$\omega_o = \frac{1}{\sqrt{R_1 C_1 R_2 C_2}}$$

$$Q = \frac{1}{(1 - K)\sqrt{\frac{R_1 C_1}{R_2 C_2}} + \sqrt{\frac{R_1 C_2}{R_2 C_1}} + \sqrt{\frac{R_2 C_2}{R_1 C_1}}}$$

$$H_{olp} = K$$

$$\omega_o = \frac{1}{RC}$$

$$Q = \frac{1}{3 - K}$$

Equations simplify if we let all components be equal R=C

FIGURE 32. SULLEN KEY LOW PASS FILTER

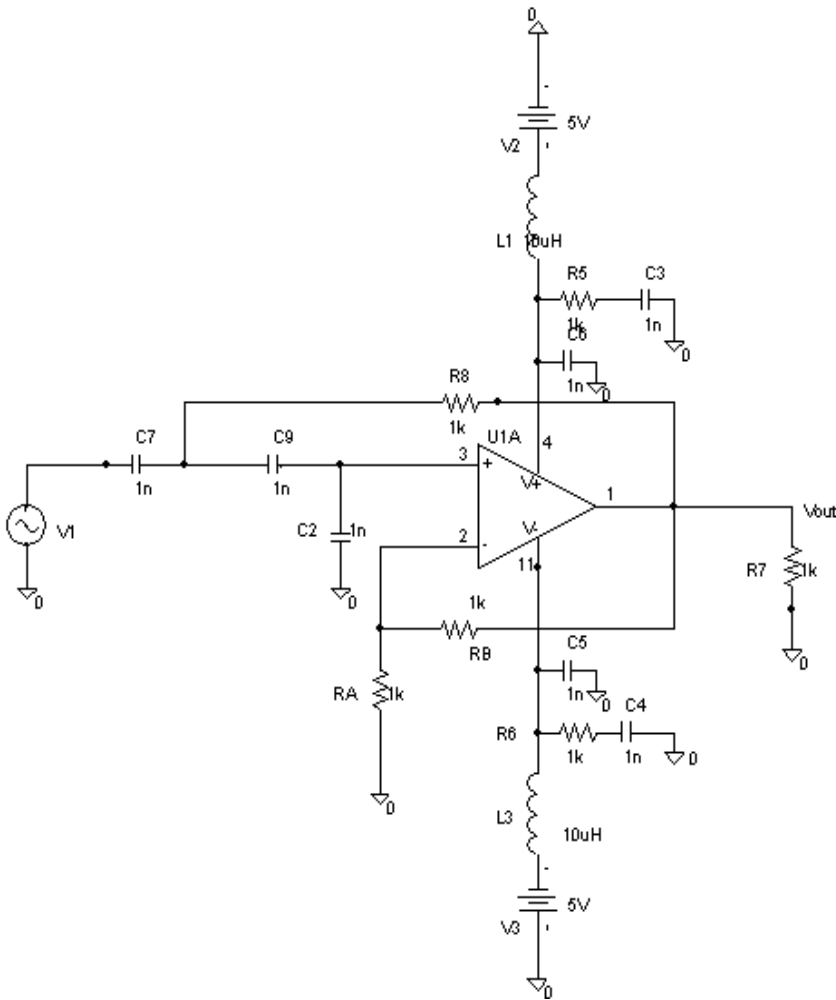

$$H_{olp} = K$$

$$\omega_o = \frac{1}{\sqrt{R_1 C_1 R_2 C_2}}$$

$$Q = \frac{1}{(1-K) \sqrt{\frac{R_1 C_1}{R_2 C_2}} + \sqrt{\frac{R_1 C_2}{R_2 C_1}} + \sqrt{\frac{R_2 C_2}{R_1 C_1}}}$$

$$H_{olp} = \frac{K}{4-K}$$

$$\omega_o = \frac{\sqrt{2}}{RC}$$

$$Q = \frac{\sqrt{2}}{4-K}$$

Equations simplify if we let all components be equal R=C

FIGURE 33. SULLEN KEY HIGH PASS FILTER

Differential Output Instrumentation Amplifier

The addition of a third amplifier to the conventional three amplifier Instrumentation Amplifier introduces the benefits of differential signal realization, specifically the advantage of using common mode rejection to remove coupled noise and ground -potential errors inherent in remote transmission. This configuration also provides enhanced bandwidth, wider output swing and faster slew rate than conventional three amplifier solutions with only the cost of an additional amplifier and few resistors.

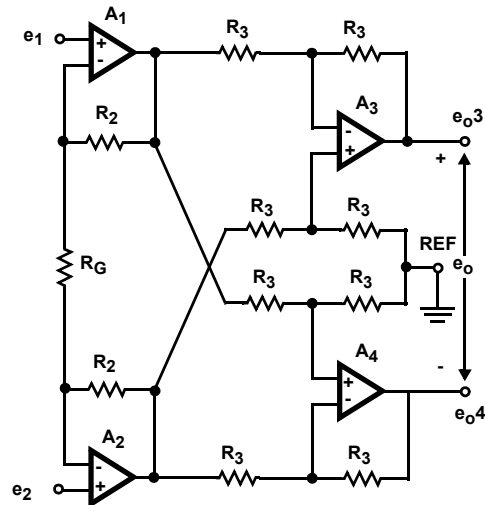

$$e_{o3} = -(1 + 2R_2/R_G)(e_1 - e_2) \quad e_{o4} = (1 + 2R_2/R_G)(e_1 - e_2)$$

$$e_o = -2(1 + 2R_2/R_G)(e_1 - e_2)$$

$$BW = \frac{2f_{C1,2}}{|A_{Di}|} \quad A_{Di} = -2(1 + 2R_2/R_G)$$

Strain Gauge

The strain gauge is an ideal application to take advantage of the moderate bandwidth and high accuracy of the EL5152. The operation of the circuit is very straight forward. As the strain variable component resistor in the balanced bridge is subjected to increasing strain its resistance changes

resulting in an imbalance in the bridge. A voltage variation from the referenced high accuracy source is generated and translated to the difference amplifier through the buffer stage. This voltage difference as a function of the strain is converted into an output voltage.

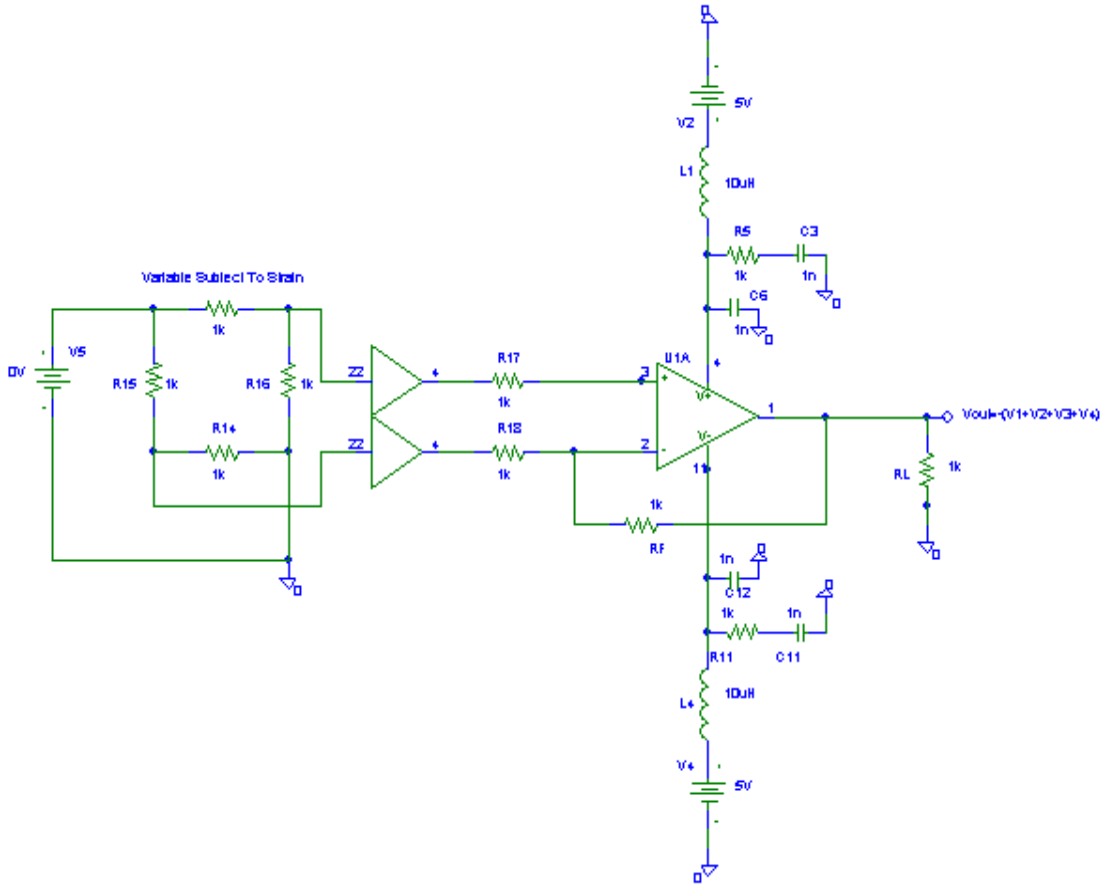

All Intersil U.S. products are manufactured, assembled and tested utilizing ISO9000 quality systems. Intersil Corporation's quality certifications can be viewed at www.intersil.com/design/quality

Intersil products are sold by description only. Intersil Corporation reserves the right to make changes in circuit design, software and/or specifications at any time without notice. Accordingly, the reader is cautioned to verify that data sheets are current before placing orders. Information furnished by Intersil is believed to be accurate and reliable. However, no responsibility is assumed by Intersil or its subsidiaries for its use; nor for any infringements of patents or other rights of third parties which may result from its use. No license is granted by implication or otherwise under any patent or patent rights of Intersil or its subsidiaries.

For information regarding Intersil Corporation and its products, see www.intersil.com