

Single 200MHz Fixed Gain Amplifier with Enable

The EL5197 and EL5197A are fixed gain amplifiers with a bandwidth of 200MHz, making these amplifiers ideal for today's high speed video and monitor applications. These amplifiers feature internal gain setting resistors and can be configured in a gain of +1, -1 or +2. The same bandwidth is seen in both gain-of-1 and gain-of-2 applications.

With a supply current of just 4mA and the ability to run from a single supply voltage from 5V to 10V, these amplifiers are also ideal for hand held, portable or battery powered equipment.

The EL5197A also incorporates an enable and disable function to reduce the supply current to 100µA typical per amplifier. Allowing the \overline{CE} pin to float or applying a low logic level will enable the amplifier.

The EL5197 is offered in the 5-pin SOT-23 package and the EL5197A is available in the 6-pin SOT-23 as well as the industry-standard 8-pin SO packages. Both operate over the industrial temperature range of -40°C to +85°C.

Ordering Information

PART NUMBER	PACKAGE	TAPE & REEL	PKG. DWG. #
EL5197CW-T7	5-Pin SOT-23*	7" (3K pcs)	MDP0038
EL5197CW-T7A	5-Pin SOT-23*	7" (250 pcs)	MDP0038
EL5197ACW-T7	6-Pin SOT-23*	7"	MDP0038
EL5197ACS	8-Pin SO	-	MDP0027
EL5197ACS-T7	8-Pin SO	7"	MDP0027
EL5197ACS-T13	8-Pin SO	13"	MDP0027
EL5197ACSZ (See Note)	8-Pin SO (Pb-free)	-	MDP0027
EL5197ACSZ-T7 (See Note)	8-Pin SO (Pb-free)	7"	MDP0027
EL5197ACSZ-T13 (See Note)	8-Pin SO (Pb-free)	13"	MDP0027

*EL5197CW & EL5197ACW symbol is .Sxxx where xxx represents date code

NOTE: Intersil Pb-free plus anneal products employ special Pb-free material sets; molding compounds/die attach materials and 100% matte tin plate termination finish, which are RoHS compliant and compatible with both SnPb and Pb-free soldering operations. Intersil Pb-free products are MSL classified at Pb-free peak reflow temperatures that meet or exceed the Pb-free requirements of IPC/JEDEC J STD-020.

Features

- Gain selectable (+1, -1, +2)
- 200MHz -3dB BW ($A_V = 1, 2$)
- 4mA supply current
- Fast enable/disable (EL5197A only)
- Single and dual supply operation, from 5V to 10V or $\pm 2.5V$ to $\pm 5V$
- Available in SOT-23 packages
- Triple (EL5397) available
- 400MHz, 9mA products available (EL5197 & EL5396)
- Pb-Free plus anneal available (RoHS compliant)

Applications

- Battery powered equipment
- Hand held, portable devices
- Video amplifiers
- Cable drivers
- RGB amplifiers
- Test equipment
- Instrumentation
- Current to voltage converters

Pinouts

**EL5197A
(8-PIN SO)
TOP VIEW**

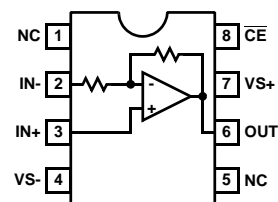

**EL5197A
(6-PIN SOT-23)
TOP VIEW**

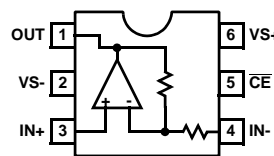

**EL5197
(5-PIN SOT-23)
TOP VIEW**

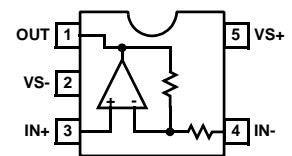

EL5197, EL5197A

Absolute Maximum Ratings (T_A = 25°C)

Supply Voltage between V_{S+} and V_{S-} 11V
 Maximum Continuous Output Current 50mA
 Operating Junction Temperature 125°C
 Power Dissipation See Curves

Pin Voltages V_{S-} -0.5V to V_{S+} +0.5V
 Storage Temperature -65°C to +150°C
 Operating Ambient Temperature -40°C to +85°C

CAUTION: Stresses above those listed in "Absolute Maximum Ratings" may cause permanent damage to the device. This is a stress only rating and operation of the device at these or any other conditions above those indicated in the operational sections of this specification is not implied.

IMPORTANT NOTE: All parameters having Min/Max specifications are guaranteed. Typical values are for information purposes only. Unless otherwise noted, all tests are at the specified temperature and are pulsed tests, therefore: T_J = T_C = T_A

Electrical Specifications V_{S+} = +5V, V_{S-} = -5V, R_L = 150Ω, T_A = 25°C unless otherwise specified.

PARAMETER	DESCRIPTION	CONDITIONS	MIN	TYP	MAX	UNIT
AC PERFORMANCE						
BW	-3dB Bandwidth	A _V = +1		200		MHz
		A _V = -1		200		MHz
		A _V = +2		200		MHz
BW1	0.1dB Bandwidth			20		MHz
SR	Slew Rate	V _O = -2.5V to +2.5V, A _V = +2	1800	2200		V/μs
t _S	0.1% Settling Time	V _{OUT} = -2.5V to +2.5V, A _V = -1		12		ns
e _N	Input Voltage Noise			4.4		nV/√Hz
i _{N-}	IN- Input Current Noise			17		pA/√Hz
i _{N+}	IN+ Input Current Noise			50		pA/√Hz
dG	Differential Gain Error (Note 1)	A _V = +2		0.03		%
dP	Differential Phase Error (Note 1)	A _V = +2		0.04		°
DC PERFORMANCE						
V _{OS}	Offset Voltage		-10	1	10	mV
T _C V _{OS}	Input Offset Voltage Temperature Coefficient	Measured from T _{MIN} to T _{MAX}		5		μV/°C
A _E	Gain Error	V _O = -3V to +3V	-2	1.3	2	%
R _F , R _G	Internal R _F and R _G		320	400	480	Ω
INPUT CHARACTERISTICS						
CMIR	Common Mode Input Range		±3V	±3.3V		V
+I _{IN}	+ Input Current		-60	1	60	μA
-I _{IN}	- Input Current		-30	1	30	μA
R _{IN}	Input Resistance	at I _{N+}		45		kΩ
C _{IN}	Input Capacitance			0.5		pF
OUTPUT CHARACTERISTICS						
V _O	Output Voltage Swing	R _L = 150Ω to GND	±3.4V	±3.7V		V
		R _L = 1kΩ to GND	±3.8V	±4.0V		V
I _{OUT}	Output Current	R _L = 10Ω to GND	95	120		mA
SUPPLY						
I _{SON}	Supply Current - Enabled	No load, V _{IN} = 0V	3	4	5	mA
I _{SOFF}	Supply Current - Disabled	No load, V _{IN} = 0V		100	150	μA
PSRR	Power Supply Rejection Ratio	DC, V _S = ±4.75V to ±5.25V	55	75		dB

EL5197, EL5197A

Electrical Specifications $V_{S+} = +5V$, $V_{S-} = -5V$, $R_L = 150\Omega$, $T_A = 25^\circ C$ unless otherwise specified. (Continued)

PARAMETER	DESCRIPTION	CONDITIONS	MIN	TYP	MAX	UNIT
-IPSR	- Input Current Power Supply Rejection	DC, $V_S = \pm 4.75V$ to $\pm 5.25V$	-2		2	$\mu A/V$
ENABLE (EL5197A ONLY)						
t_{EN}	Enable Time			40		ns
t_{DIS}	Disable Time (Note 2)			600		ns
I_{IHCE}	CE Pin Input High Current	$\overline{CE} = V_{S+}$		0.8	6	μA
I_{ILCE}	CE Pin Input Low Current	$\overline{CE} = V_{S-}$		0	-0.1	μA
V_{IHCE}	CE Input High Voltage for Disable		$V_{S+} - 1$			V
V_{ILCE}	CE Input Low Voltage for Enable				$V_{S+} - 3$	V

NOTES:

- Standard NTSC test, AC signal amplitude = $286mV_{P-P}$, $f = 3.58MHz$
- Measured from the application of \overline{CE} logic until the output voltage is at the 50% point between initial and final values

Typical Performance Curves

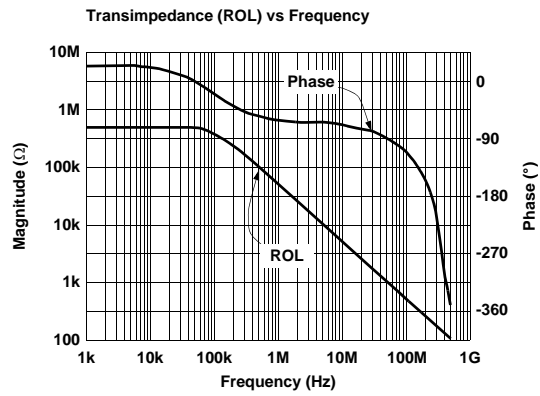
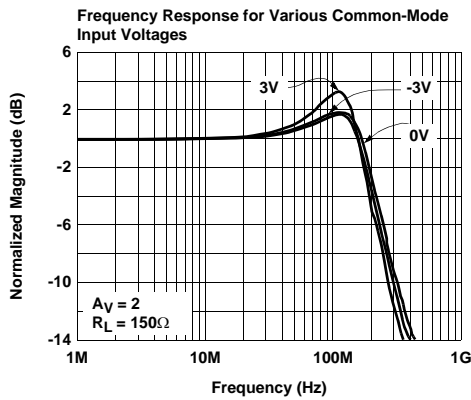
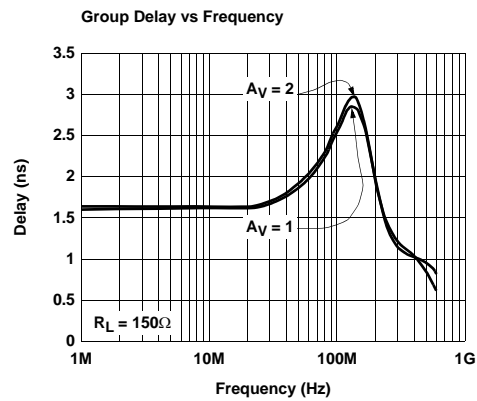
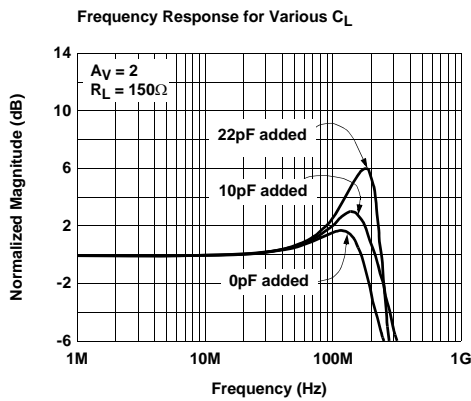
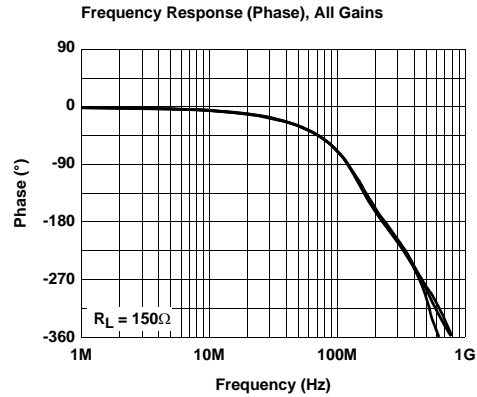
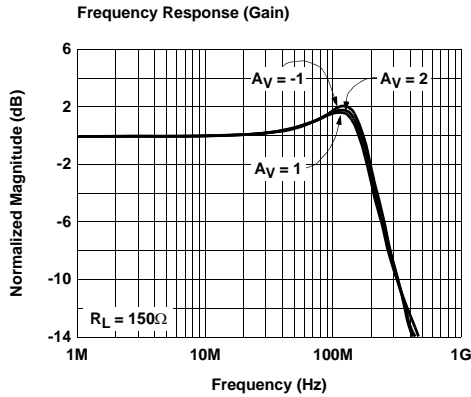

Typical Performance Curves (Continued)

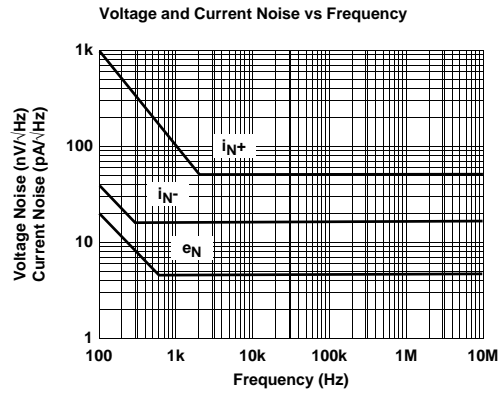
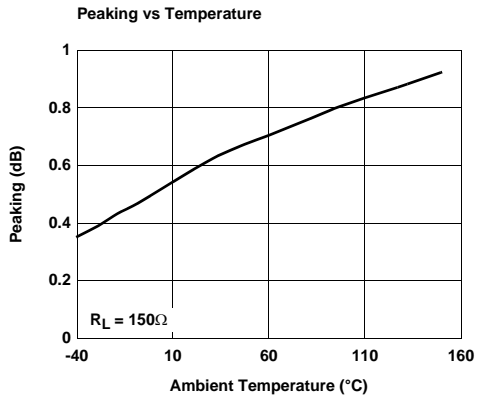
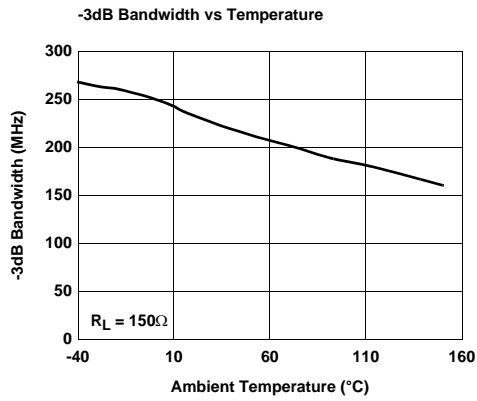
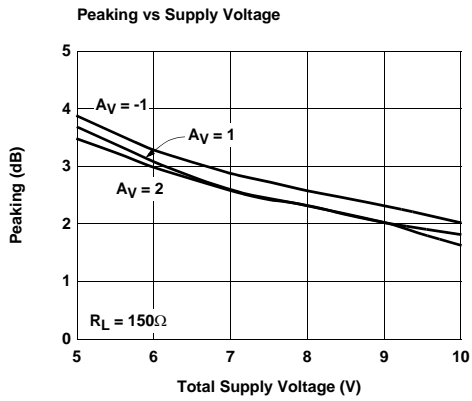
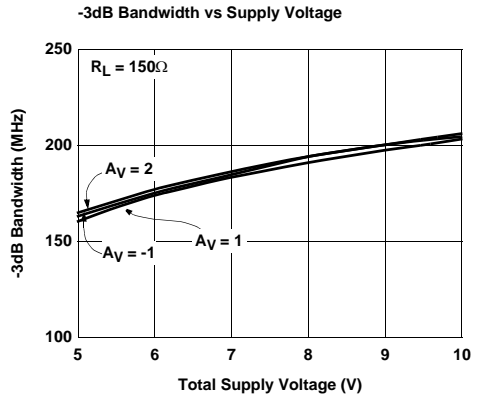
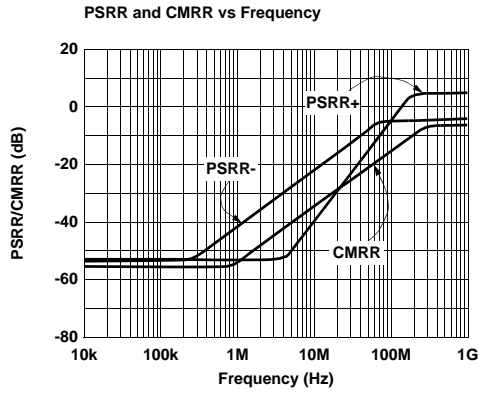

Typical Performance Curves (Continued)

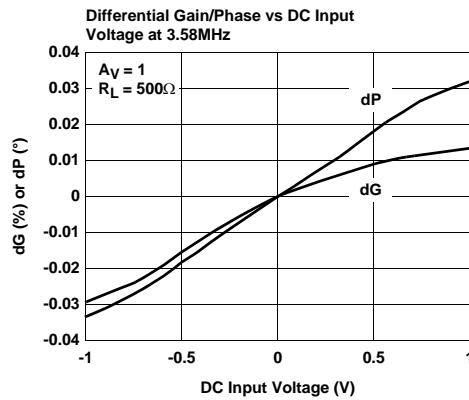
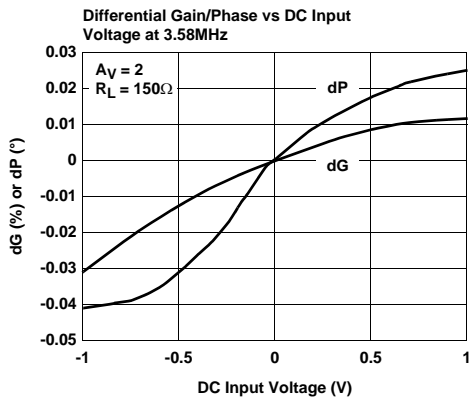
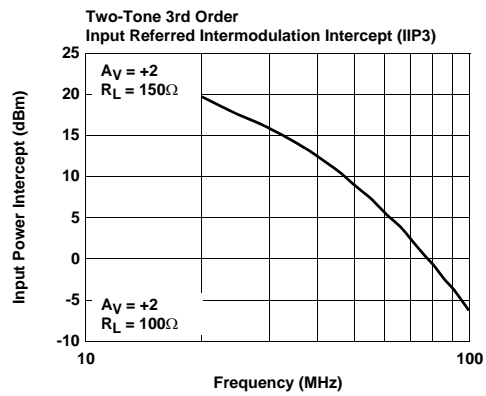
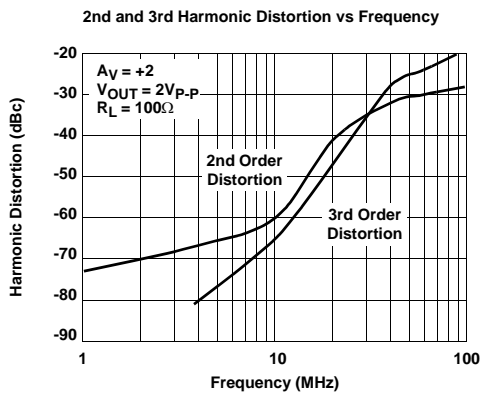
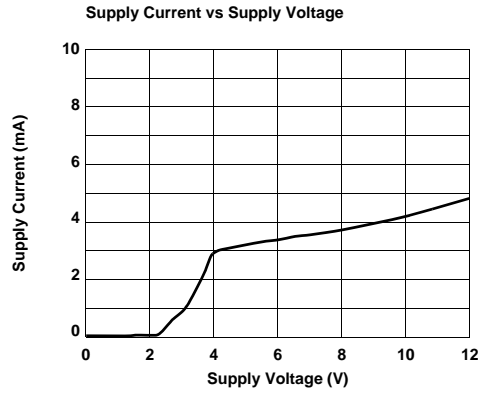
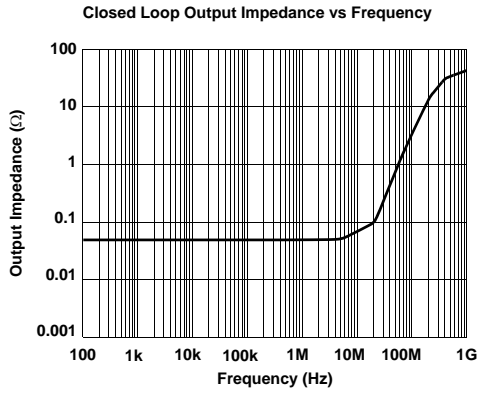

Typical Performance Curves (Continued)

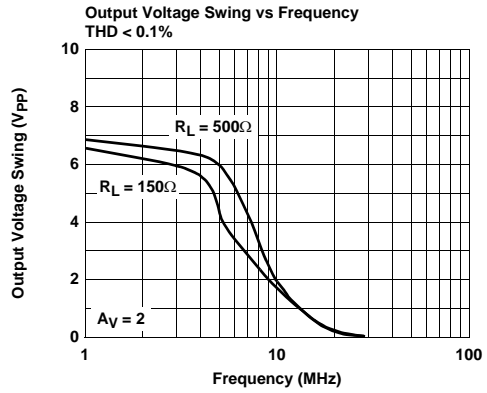
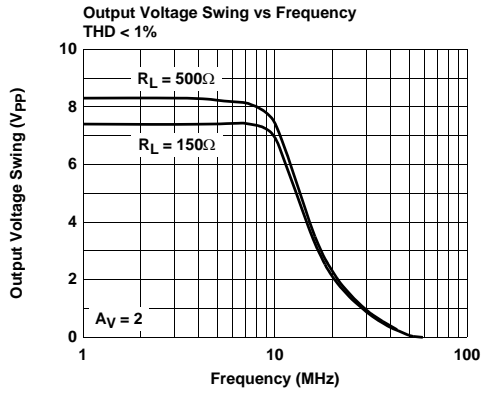

Small Signal Step Response

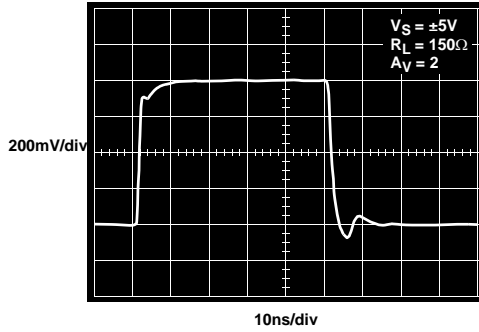

Large Signal Step Response

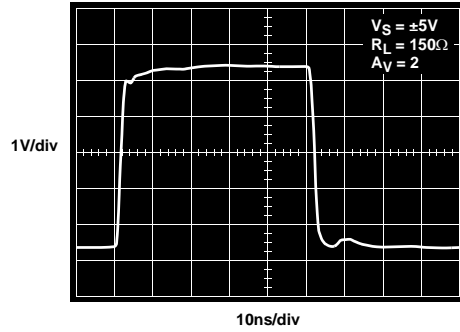

Settling Time vs Settling Accuracy

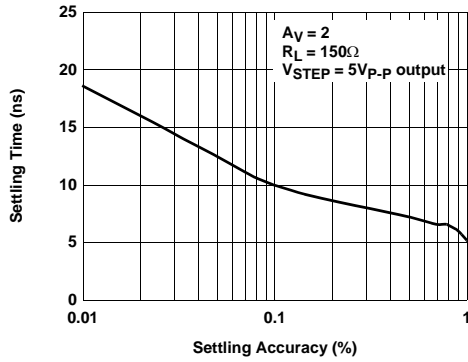

Transimpedance (RoI) vs Temperature

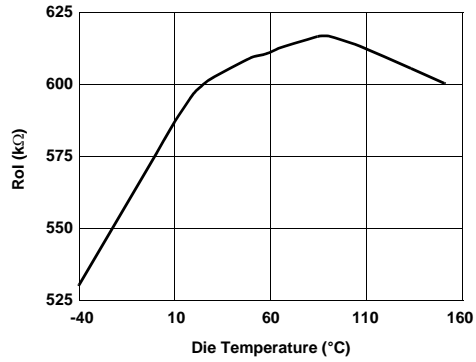

Typical Performance Curves (Continued)

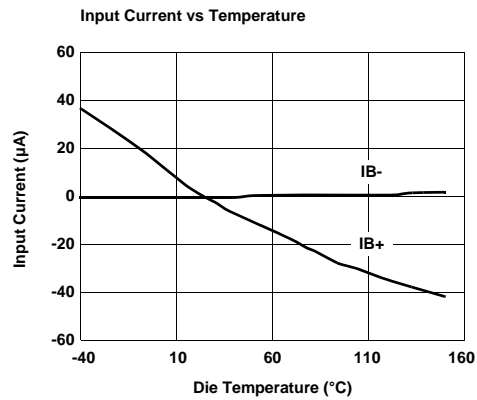
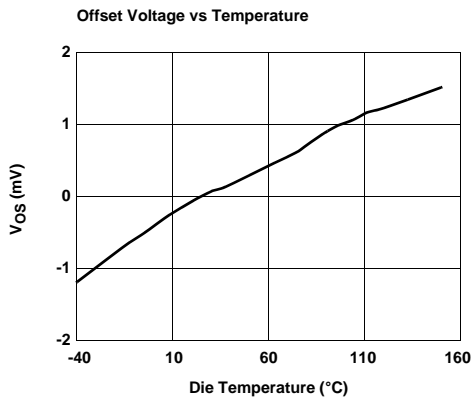
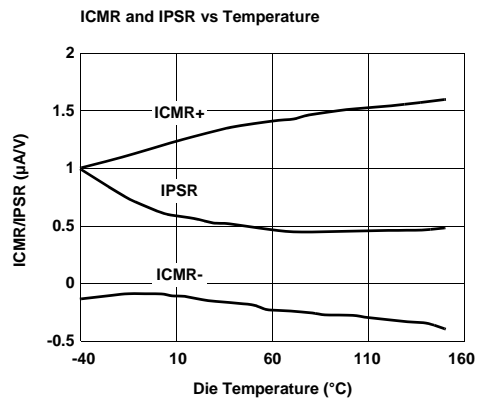
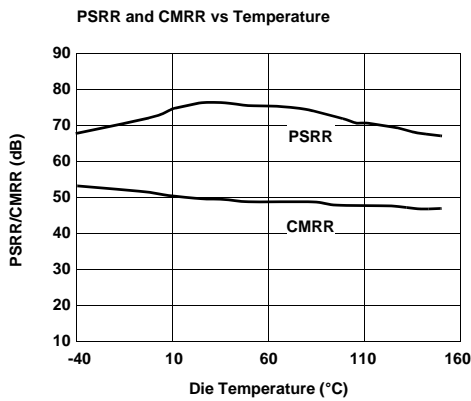
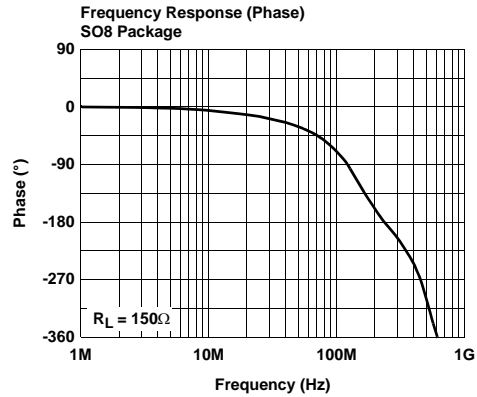
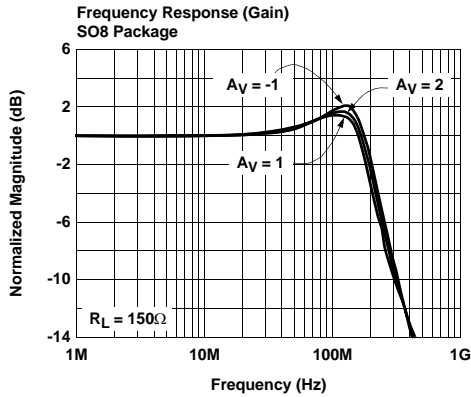

Typical Performance Curves (Continued)

Positive Input Resistance vs Temperature

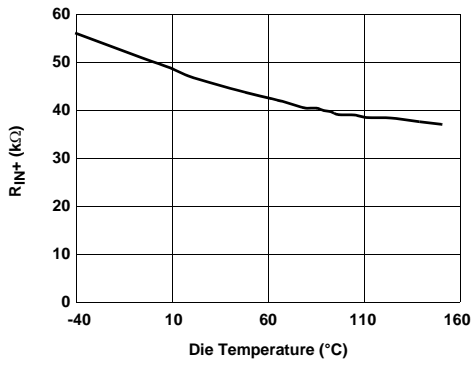

Supply Current vs Temperature

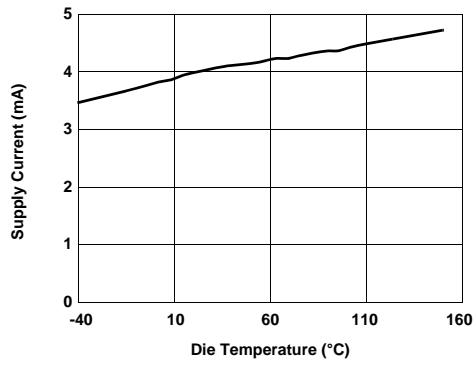

Positive Output Swing vs Temperature for Various Loads

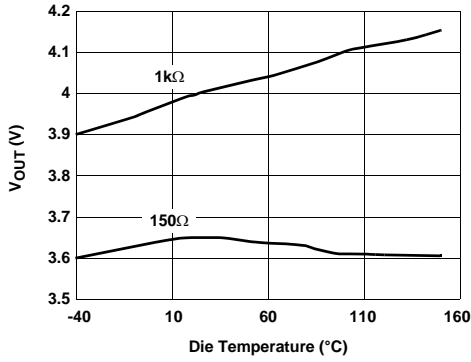

Negative Output Swing vs Temperature for Various Loads

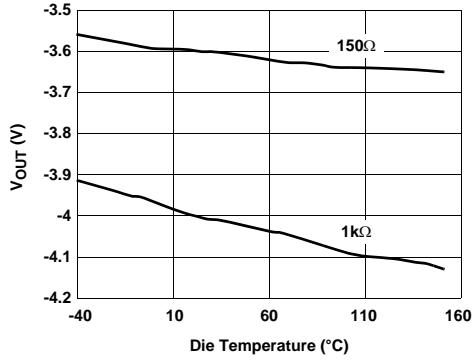

Output Current vs Temperature

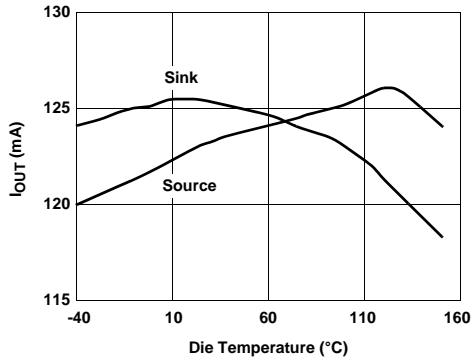

Slew Rate vs Temperature

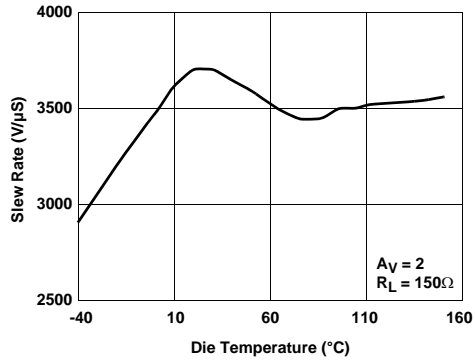

Typical Performance Curves (Continued)

Enable Response

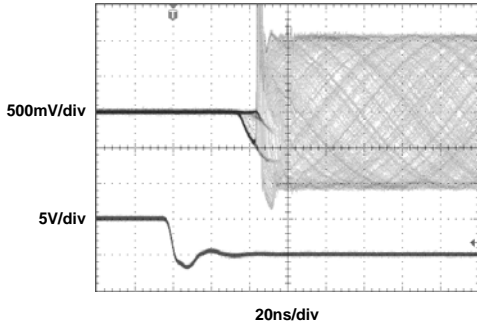

Disable Response

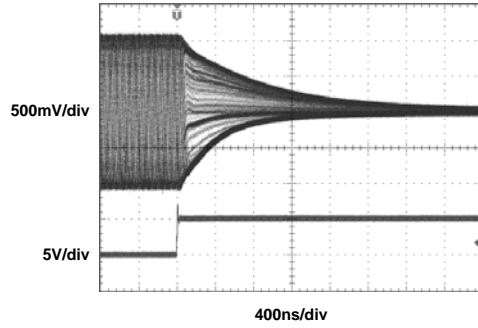

Package Power Dissipation vs Ambient Temperature
JEDEC JESD51-3 Low Effective Thermal Conductivity
Test Board

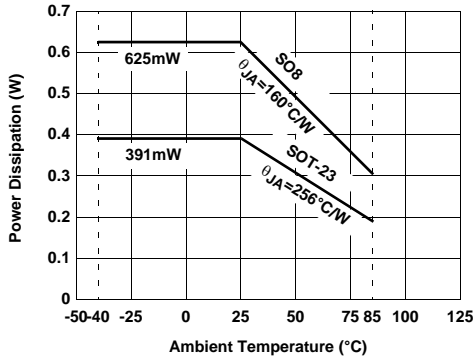

Package Power Dissipation vs Ambient Temperature
JEDEC JESD51-7 High Effective Thermal Conductivity
Test Board

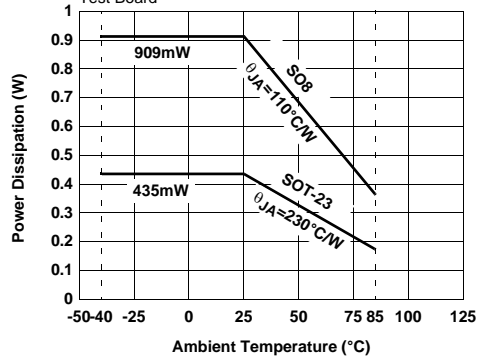

Pin Descriptions

8-PIN SO	5-PIN SOT-23	6-PIN SOT-23	PIN NAME	FUNCTION	EQUIVALENT CIRCUIT
1, 5			NC	Not connected	
2	4	4	IN-	Inverting input	<p style="text-align: center;">Circuit 1</p>
3	3	3	IN+	Non-inverting input	(See circuit 1)
4	2	2	V _{S-}	Negative supply	
6	1	1	OUT	Output	<p style="text-align: center;">Circuit 2</p>
7	5	6	V _{S+}	Positive supply	
8		5	$\overline{\text{CE}}$	Chip enable	<p style="text-align: center;">Circuit 3</p>

Applications Information

Product Description

The EL5197 is a fixed gain amplifier that offers a wide -3dB bandwidth of 200MHz and a low supply current of 4mA. The EL5197 works with supply voltages ranging from a single 5V to 10V and they are also capable of swinging to within 1V of either supply on the output. This combination of high bandwidth and low power, together with aggressive pricing make the EL5197 the ideal choice for many low-power/high-bandwidth applications such as portable, handheld, or battery-powered equipment.

For varying bandwidth and higher gains, consider the EL5191 with 1GHz on a 9mA supply current or the EL5193 with 300MHz on a 4mA supply current. Versions include single, dual, and triple amp packages with 5-pin SOT-23, 16-pin QSOP, and 8-pin or 16-pin SO outlines.

Power Supply Bypassing and Printed Circuit Board Layout

As with any high frequency device, good printed circuit board layout is necessary for optimum performance. Low impedance ground plane construction is essential. Surface mount components are recommended, but if leaded components are used, lead lengths should be as short as possible. The power supply pins must be well bypassed to reduce the risk of oscillation. The combination of a 4.7µF tantalum capacitor in parallel with a 0.01µF capacitor has been shown to work well when placed at each supply pin.

Disable/Power-Down

The EL5197A amplifier can be disabled placing its output in a high impedance state. When disabled, the amplifier supply current is reduced to < 150µA. The EL5197A is disabled when its \overline{CE} pin is pulled up to within 1V of the positive supply. Similarly, the amplifier is enabled by floating or pulling its \overline{CE} pin to at least 3V below the positive supply. For ±5V supply, this means that an EL5197A amplifier will be enabled when \overline{CE} is 2V or less, and disabled when \overline{CE} is above 4V. Although the logic levels are not standard TTL, this choice of logic voltages allows the EL5197A to be enabled by tying \overline{CE} to ground, even in 5V single supply applications. The \overline{CE} pin can be driven from CMOS outputs.

Gain Setting

The EL5197A is built with internal feedback and gain resistors. The internal feedback resistors have equal value; as a result, the amplifier can be configured into gain of +1, -1, and +2 without any external resistors. Figure 1 shows the amplifier in gain of +2 configuration. The gain error is ±2% maximum. Figure 2 shows the amplifier in gain of -1 configuration. For gain of +1, IN+ and IN- should be connected together as shown in Figure 3. This configuration avoids the effects of any parasitic capacitance on the IN- pin. Since the internal feedback and gain resistors change with

temperature and process, external resistor should not be used to adjust the gain settings.

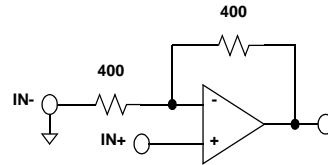

FIGURE 1. $A_V = +2$

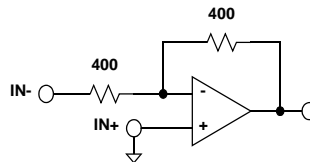

FIGURE 2. $A_V = -1$

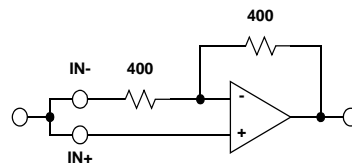

FIGURE 3. $A_V = +1$

Supply Voltage Range and Single-Supply Operation

The EL5197 has been designed to operate with supply voltages having a span of greater than or equal to 5V and less than 11V. In practical terms, this means that the EL5197 will operate on dual supplies ranging from ±2.5V to ±5V. With single-supply, the EL5197 will operate from 5V to 10V.

As supply voltages continue to decrease, it becomes necessary to provide input and output voltage ranges that can get as close as possible to the supply voltages. The EL5197 has an input range which extends to within 2V of either supply. So, for example, on ±5V supplies, the EL5197 has an input range which spans ±3V. The output range of the EL5197 is also quite large, extending to within 1V of the supply rail. On a ±5V supply, the output is therefore capable of swinging from -4V to +4V. Single-supply output range is larger because of the increased negative swing due to the

external pull-down resistor to ground. Figure 4 shows an AC-coupled, gain of +2, +5V single supply circuit configuration.

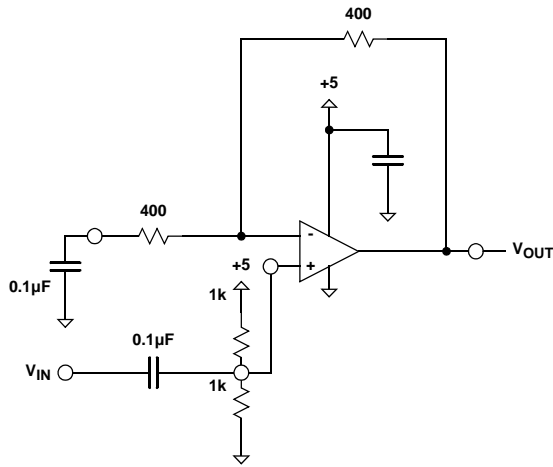

FIGURE 4.

Video Performance

For good video performance, an amplifier is required to maintain the same output impedance and the same frequency response as DC levels are changed at the output. This is especially difficult when driving a standard video load of 150Ω, because of the change in output current with DC level. Previously, good differential gain could only be achieved by running high idle currents through the output transistors (to reduce variations in output impedance.) These currents were typically comparable to the entire 4mA supply current of each EL5197 amplifier. Special circuitry has been incorporated in the EL5197 to reduce the variation of output impedance with current output. This results in dG and dP specifications of 0.03% and 0.04°, while driving 150Ω at a gain of 2.

Video performance has also been measured with a 500Ω load at a gain of +1. Under these conditions, the EL5197 has dG and dP specifications of 0.03% and 0.04°, respectively.

Output Drive Capability

In spite of its low 4mA of supply current, the EL5197 is capable of providing a minimum of ±95mA of output current with a minimum of ±95mA of output drive.

Driving Cables and Capacitive Loads

When used as a cable driver, double termination is always recommended for reflection-free performance. For those applications, the back-termination series resistor will

decouple the EL5197 from the cable and allow extensive capacitive drive. However, other applications may have high capacitive loads without a back-termination resistor. In these applications, a small series resistor (usually between 5Ω and 50Ω) can be placed in series with the output to eliminate most peaking.

Current Limiting

The EL5197 has no internal current-limiting circuitry. If the output is shorted, it is possible to exceed the Absolute Maximum Rating for output current or power dissipation, potentially resulting in the destruction of the device.

Power Dissipation

With the high output drive capability of the EL5197, it is possible to exceed the 125°C Absolute Maximum junction temperature under certain very high load current conditions. Generally speaking when R_L falls below about 25Ω, it is important to calculate the maximum junction temperature (T_{JMAX}) for the application to determine if power supply voltages, load conditions, or package type need to be modified for the EL5197 to remain in the safe operating area. These parameters are calculated as follows:

$$T_{JMAX} = T_{MAX} + (\theta_{JA} \times n \times PD_{MAX})$$

where:

- T_{MAX} = Maximum ambient temperature
- θ_{JA} = Thermal resistance of the package
- n = Number of amplifiers in the package
- PD_{MAX} = Maximum power dissipation of each amplifier in the package

PD_{MAX} for each amplifier can be calculated as follows:

$$PD_{MAX} = (2 \times V_S \times I_{SMAX}) + \left[(V_S - V_{OUTMAX}) \times \frac{V_{OUTMAX}}{R_L} \right]$$

where:

- V_S = Supply voltage
- I_{SMAX} = Maximum supply current of 1A
- V_{OUTMAX} = Maximum output voltage (required)
- R_L = Load resistance

All Intersil U.S. products are manufactured, assembled and tested utilizing ISO9000 quality systems. Intersil Corporation's quality certifications can be viewed at www.intersil.com/design/quality

Intersil products are sold by description only. Intersil Corporation reserves the right to make changes in circuit design, software and/or specifications at any time without notice. Accordingly, the reader is cautioned to verify that data sheets are current before placing orders. Information furnished by Intersil is believed to be accurate and reliable. However, no responsibility is assumed by Intersil or its subsidiaries for its use; nor for any infringements of patents or other rights of third parties which may result from its use. No license is granted by implication or otherwise under any patent or patent rights of Intersil or its subsidiaries.

For information regarding Intersil Corporation and its products, see www.intersil.com