

**Dual, 400kHz, Ultra-Low Power Operational Amplifier**

The HA-5142 ultra-low power operational amplifier provides AC and DC performance characteristics similar to or better than most general purpose amplifiers while only drawing 1/30 of the supply current of most general purpose amplifiers. In applications which require low power dissipation and good AC electrical characteristics, this device offers the industry's best speed/power ratio.

The HA-5142 provides accurate signal processing by virtue of its low input offset voltage (2mV), low input bias current (45nA), high open loop gain (100kV/V) and low noise (20nV/√Hz), for low power operational amplifiers. These characteristics coupled with a 1.5V/μs slew rate and a 400kHz bandwidth make the HA-5142 ideal for use in low power instrumentation, audio amplifier and active filter designs. The wide range of supply voltages (3V to 30V) also allow this amplifier to be very useful in low voltage battery powered equipment. This device is also tested and guaranteed at both ±15V and single ended +5V supplies.

This amplifier is available with industry standard pinouts which allow the HA-5142 to be interchangeable with most other dual operational amplifiers. For military grade product refer to the HA-5142/883 data sheet.

**Pinout**

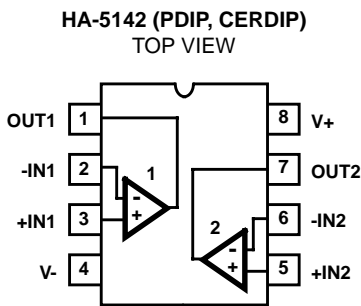

**Features**

- Low Supply Current . . . . . 45μA/Amp
- Wide Supply Voltage Range Single . . . . . 3V to 30V  
- or Dual . . . . . ±1.5V to ±15V
- High Slew Rate. . . . . 1.5V/μs
- High Gain . . . . . 100kV/V
- Unity Gain Stable

**Applications**

- Portable Instruments
- Meter Amplifiers
- Telephone Headsets
- Microphone Amplifiers
- Instrumentation  
- For Further Design Ideas See Application Note 544

**Ordering Information**

PART NUMBER	TEMP. RANGE (°C)	PACKAGE	PKG. NO.
HA3-5142-5	0 to 75	8 Ld PDIP	E8.3
HA7-5142-2	-55 to 125	8 Ld CERDIP	F8.3A

Schematic Diagram

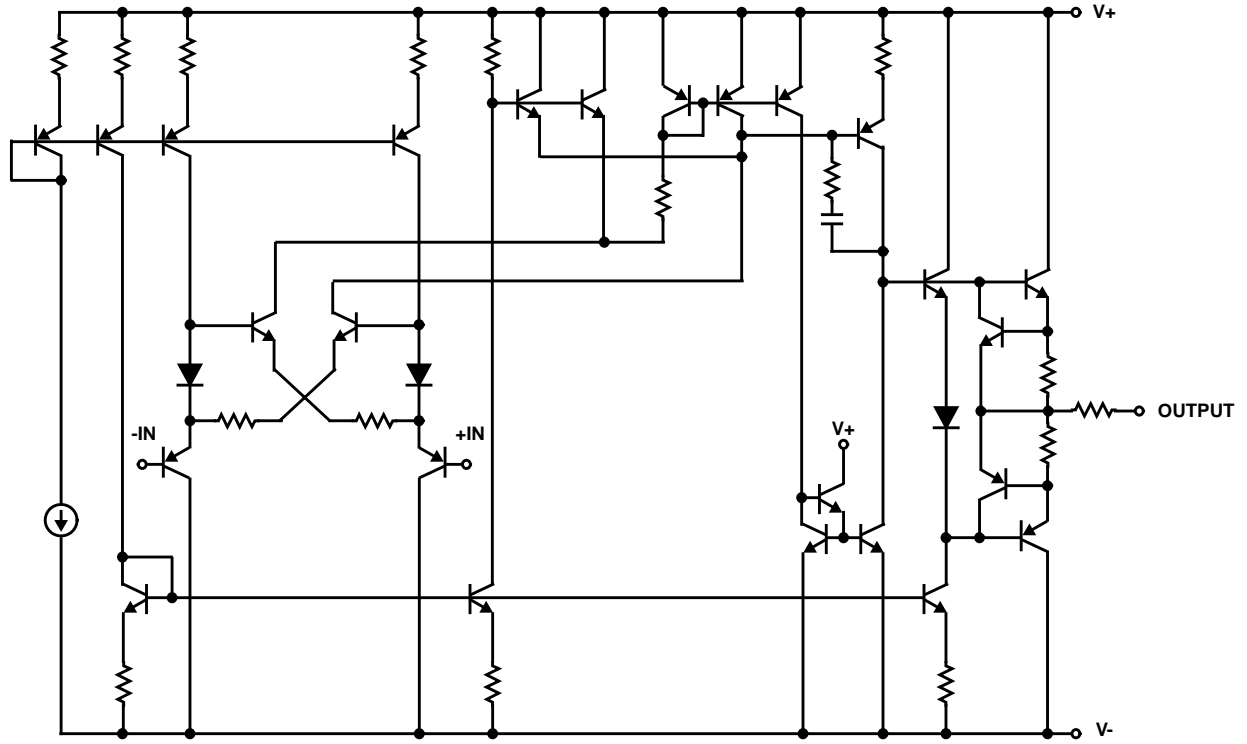

# HA-5142

## Absolute Maximum Ratings

Supply Voltage Between V+ and V- Terminals . . . . . 35V  
 Differential Input Voltage . . . . . 7V  
 Output Current . . . . . Short Circuit Protected

## Operating Conditions

Temperature Range  
 HA-5142-5 . . . . . 0°C to 75°C  
 HA-5142-2 . . . . . -55°C to 125°C

## Thermal Information

Thermal Resistance (Typical, Note 1)  $\theta_{JA}$  (°C/W)  $\theta_{JC}$  (°C/W)  
 8 Lead PDIP Package . . . . . 120 N/A  
 8 Lead CERDIP Package . . . . . 135 50  
 Maximum Junction Temperature (Hermetic Packages) . . . . . 175°C  
 Maximum Junction Temperature (Plastic Packages) . . . . . 150°C  
 Maximum Storage Temperature Range . . . . . -65°C to 150°C  
 Maximum Lead Temperature (Soldering 10s) . . . . . 300°C

*CAUTION: Stresses above those listed in "Absolute Maximum Ratings" may cause permanent damage to the device. This is a stress only rating and operation of the device at these or any other conditions above those indicated in the operational sections of this specification is not implied.*

### NOTE:

- $\theta_{JA}$  is measured with the component mounted on an evaluation PC board in free air.

## Electrical Specifications $R_S = 100\Omega$ , $C_L \leq 10pF$ , Unless Otherwise Specified

PARAMETER	TEST CONDITIONS	TEMP. (°C)	-2, -5 V+ = +5V, V- = 0V			-2, -5 V+ = +15V, V- = -15V			UNITS
			MIN	TYP	MAX	MIN	TYP	MAX	
			<b>INPUT CHARACTERISTICS</b>						
Offset Voltage	Note 11	25	-	2	6	-	2	6	mV
		Full	-	-	8	-	-	8	mV
Average Offset Voltage Drift		Full	-	3	-	-	3	-	$\mu V/^\circ C$
Bias Current	Note 11	25	-	45	100	-	45	100	nA
		Full	-	-	125	-	-	125	nA
Offset Current	Note 11	25	-	0.3	10	-	0.3	10	nA
		Full	-	-	20	-	-	20	nA
Common Mode Range		Full	0 to 3	-	-	$\pm 10$	-	-	V
Differential Input Resistance		25	-	0.6	-	-	0.6	-	M $\Omega$
Input Noise Voltage	f = 1kHz	25	-	20	-	-	20	-	nV/ $\sqrt{Hz}$
Input Noise Current	f = 1kHz	25	-	0.25	-	-	0.25	-	pA/ $\sqrt{Hz}$
<b>TRANSFER CHARACTERISTICS</b>									
Large Signal Voltage Gain	Notes 2, 4	25	20	100	-	20	100	-	kV/V
		Full	15	-	-	15	-	-	kV/V
Common Mode Rejection Ratio	Note 7	Full	77	105	-	77	105	-	dB
Bandwidth	Notes 2, 3	25	-	0.4	-	-	0.4	-	MHz
<b>OUTPUT CHARACTERISTICS</b>									
Output Voltage Swing	Notes 2, 10	25	1.0 to 3.8	0.7 to 4.2	-	$\pm 10$	$\pm 13$	-	V
		Full	1.2 to 3.5	0.9 to 4.0	-	$\pm 10$	$\pm 13$	-	V
Full Power Bandwidth	Notes 2, 4, 8	25	-	240	-	-	24	-	kHz

**Electrical Specifications**  $R_S = 100\Omega$ ,  $C_L \leq 10pF$ , Unless Otherwise Specified (Continued)

PARAMETER	TEST CONDITIONS	TEMP. (°C)	-2, -5 V+ = +5V, V- = 0V			-2, -5 V+ = +15V, V- = -15V			UNITS
			MIN	TYP	MAX	MIN	TYP	MAX	
<b>TRANSIENT RESPONSE</b> (Notes 2, 3)									
Rise Time		25	-	600	-	-	600	-	ns
Slew Rate	Note 6	25	0.8	1.5	-	0.8	1.5	-	V/ $\mu$ s
Settling Time	Note 5	25	-	10	-	-	10	-	$\mu$ s
<b>POWER SUPPLY CHARACTERISTICS</b>									
Supply Current		25	-	45	80	-	100	150	$\mu$ A/Amp
		Full	-	-	100	-	-	200	$\mu$ A/Amp
Power Supply Rejection Ratio	Note 9	Full	77	105	-	77	105	-	dB

NOTES:

2.  $R_L = 50k\Omega$ .
3.  $C_L = 50pF$ .
4.  $V_O = 1.4$  to  $2.5V$  for  $V_{SUPPLY} = +5, 0V$ ;  $V_O = \pm 10V$  for  $V_{SUPPLY} = \pm 15V$ .
5. Settling Time is specified to 0.1% of final value for a 3V output step and  $A_V = -1$  for  $V_{SUPPLY} = +5V, 0V$ . Output step = 10V for  $V_{SUPPLY} = \pm 15V$ .
6. Maximum input slew rate = 10V/ $\mu$ s.
7.  $V_{CM} = 0$  to 3V for  $V_{SUPPLY} = +5, 0V$ ;  $V_{CM} = \pm 10V$  for  $V_{SUPPLY} = \pm 15V$ .
8. Full Power Bandwidth is guaranteed by equation:  $FPBW = \frac{\text{Slew Rate}}{2\pi V_{PEAK}}$ .
9.  $\Delta V_S = +10V$  for  $V_{SUPPLY} = +5, 0V$ ;  $\Delta V_S = \pm 5V$  for  $V_{SUPPLY} = \pm 15V$ .
10. For  $V_{SUPPLY} = +5, 0V$  terminate  $R_L$  at +2.5V. Typical output current is  $\pm 3mA$ .
11.  $V_O = 1.4V$  for  $V_{SUPPLY} = +5V, 0V$ .

Test Circuits and Waveforms

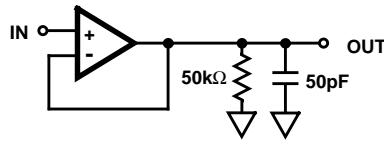
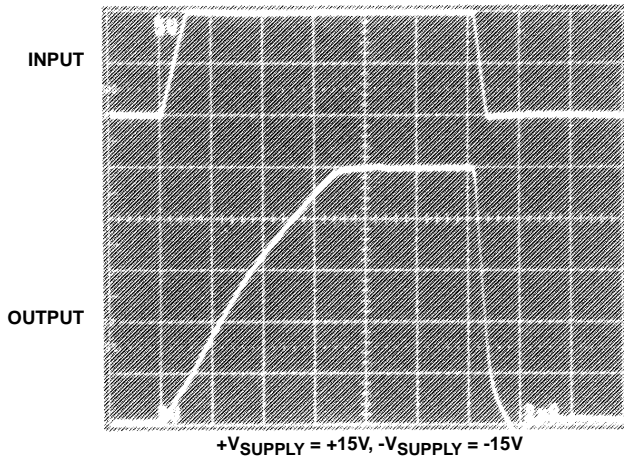
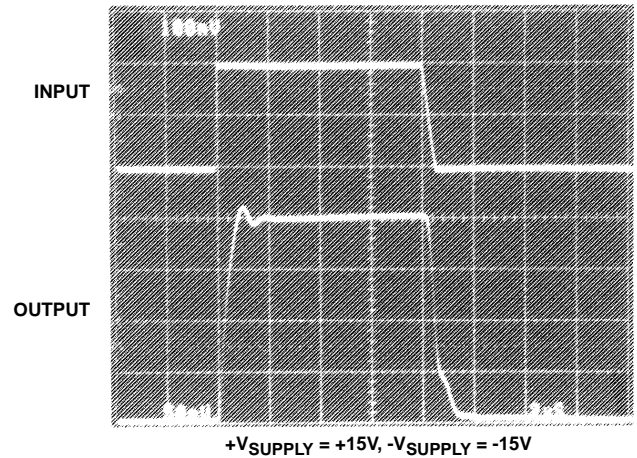

FIGURE 1. SLEW RATE AND TRANSIENT RESPONSE TEST CIRCUIT



Vertical Scale: Input = 5V/Div.; Output = 2V/Div.  
Horizontal Scale: 2μs/Div.

LARGE SIGNAL RESPONSE



Vertical Scale: Input = 100mV/Div.; Output = 50mV/Div.  
Horizontal Scale: 2μs/Div.

SMALL SIGNAL RESPONSE

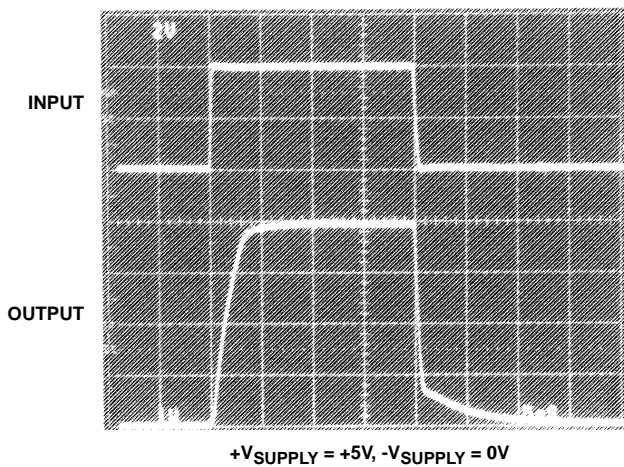

Vertical Scale: Input = 2V/Div.; Output = 1V/Div.  
Horizontal Scale: 5μs/Div.

LARGE SIGNAL RESPONSE

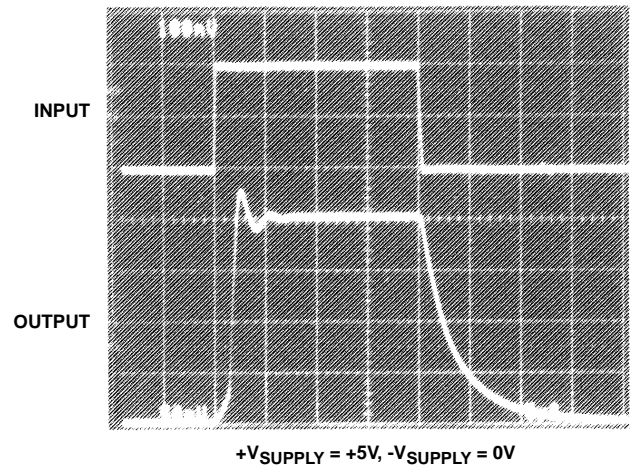

Vertical Scale: Input = 100mV/Div.; Output = 50mV/Div.  
Horizontal Scale: 5μs/Div.

SMALL SIGNAL RESPONSE

**Typical Performance Curves**  $V_S = \pm 2.5V$ ,  $T_A = 25^\circ C$ , Unless Otherwise Specified

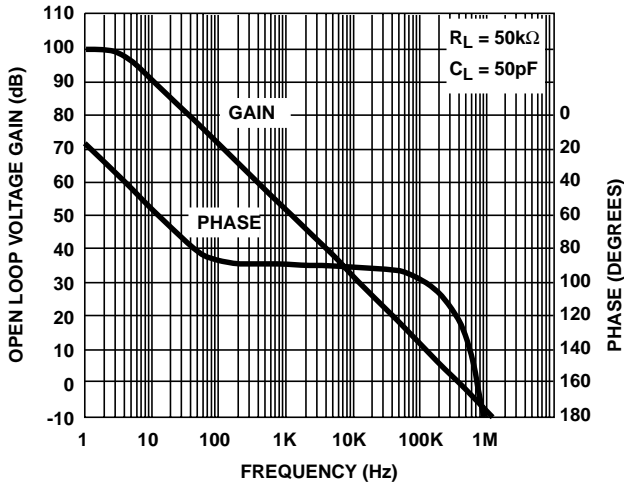

FIGURE 2. OPEN LOOP FREQUENCY RESPONSE

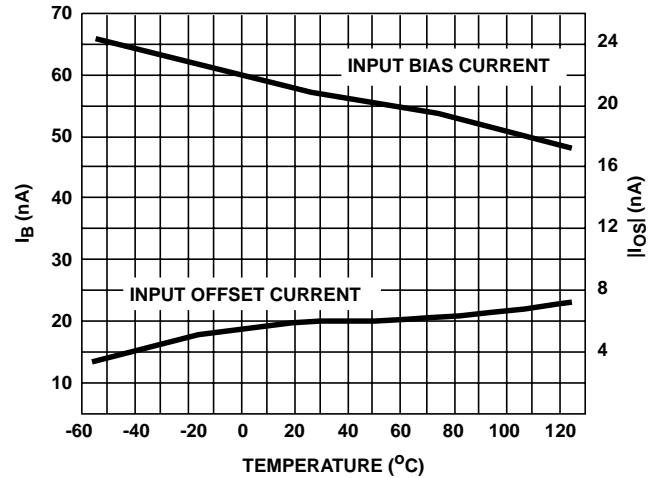

FIGURE 3. INPUT OFFSET CURRENT AND BIAS CURRENT vs TEMPERATURE

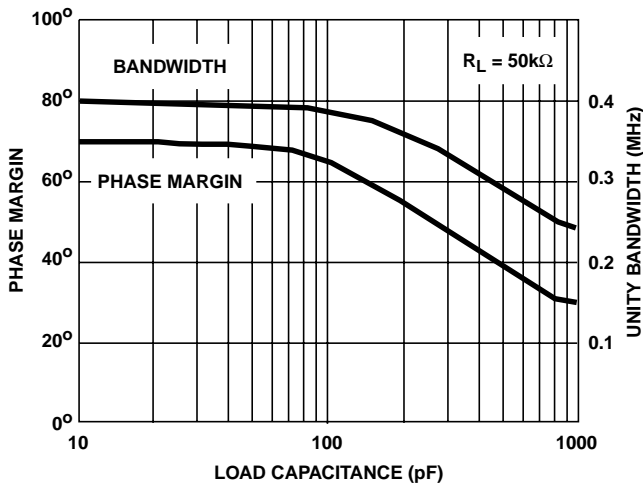

FIGURE 4. BANDWIDTH AND PHASE MARGIN vs LOAD CAPACITANCE

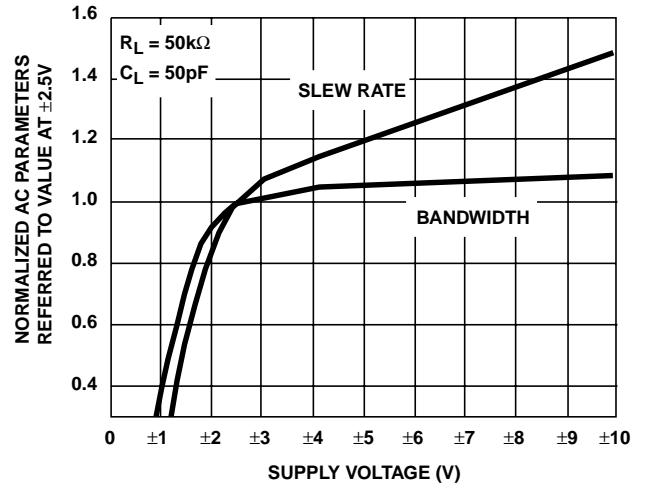

FIGURE 5. NORMALIZED AC PARAMETERS vs SUPPLY VOLTAGE

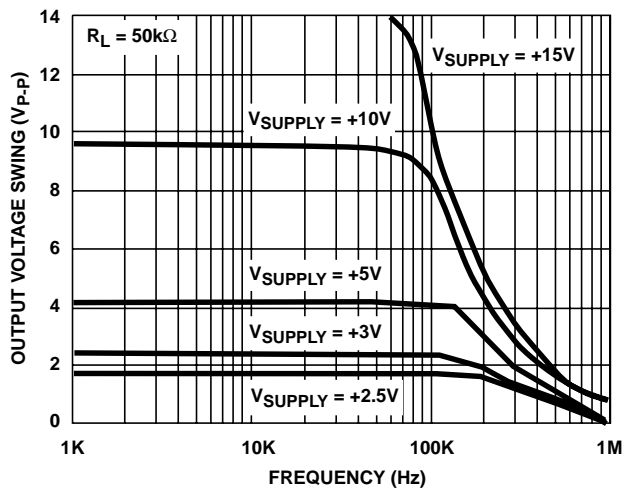

FIGURE 6. OUTPUT VOLTAGE SWING vs FREQUENCY AND SINGLE SUPPLY VOLTAGE

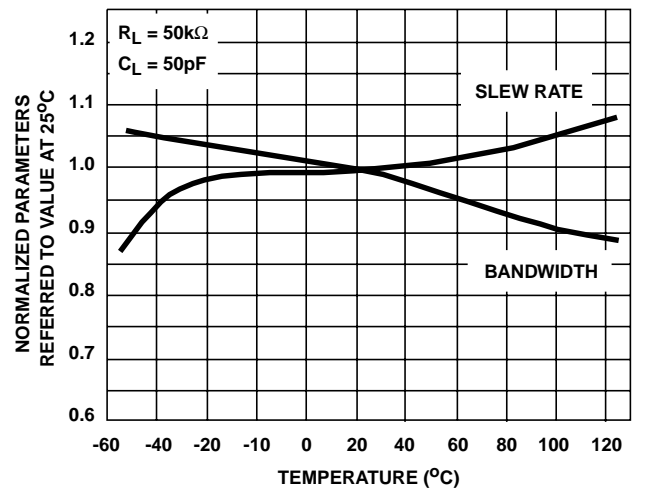

FIGURE 7. NORMALIZED AC PARAMETERS vs TEMPERATURE

Typical Performance Curves  $V_S = \pm 2.5V, T_A = 25^\circ C$ , Unless Otherwise Specified (Continued)

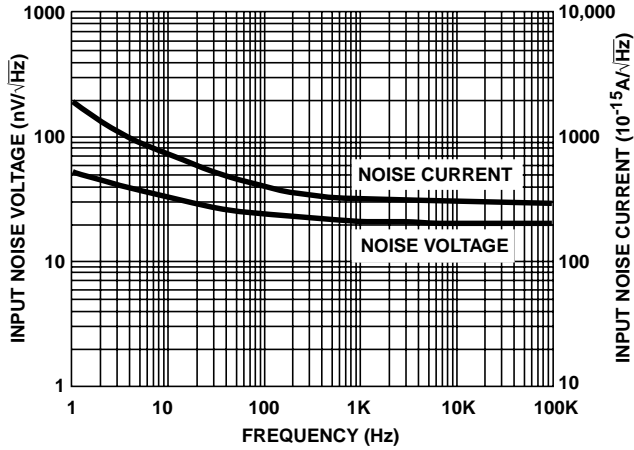

FIGURE 8. INPUT NOISE vs FREQUENCY

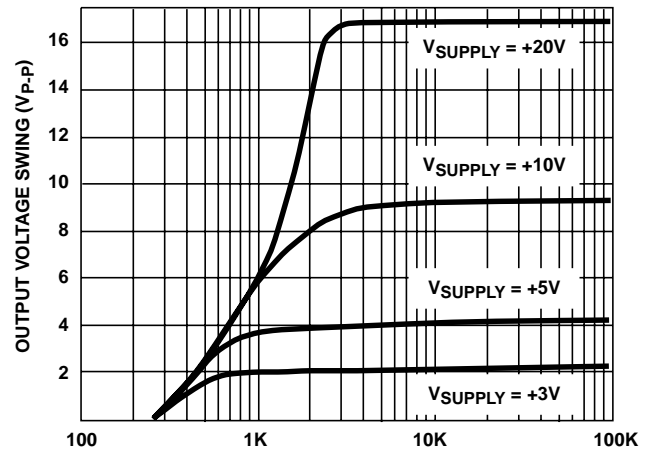

FIGURE 9. MAXIMUM OUTPUT VOLTAGE SWING vs LOAD RESISTANCE AND SINGLE SUPPLY VOLTAGE

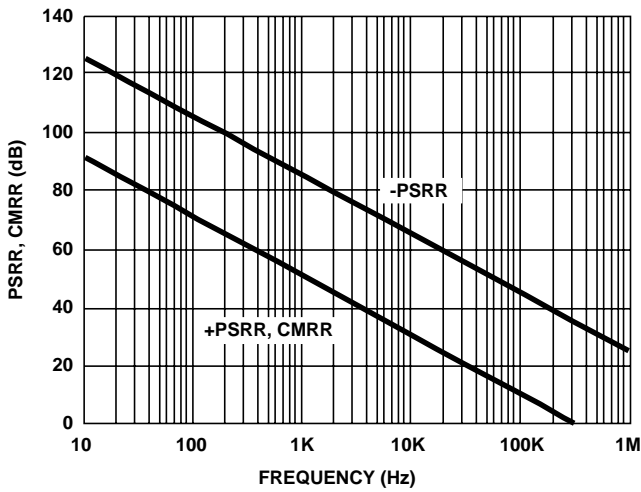

FIGURE 10. PSRR AND CMRR vs FREQUENCY

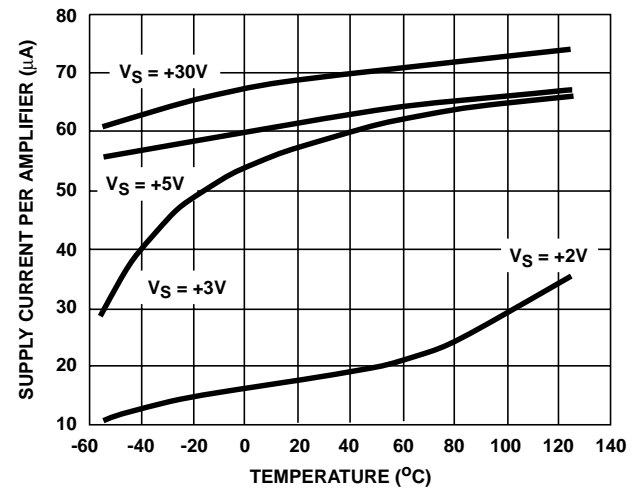

FIGURE 11. POWER SUPPLY CURRENT vs TEMPERATURE AND SINGLE SUPPLY VOLTAGE

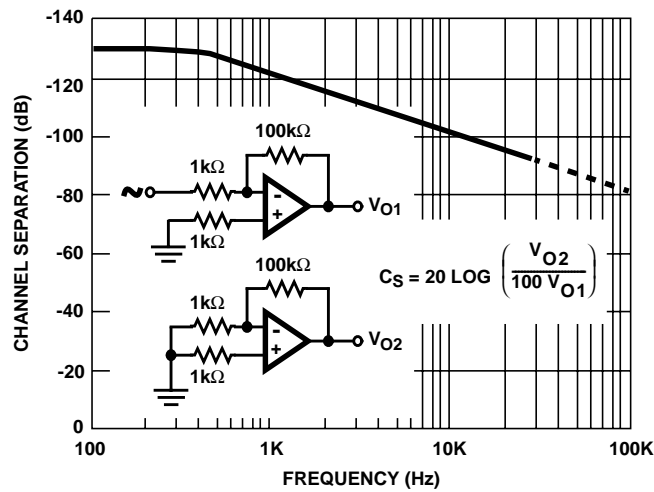

FIGURE 12. CHANNEL SEPARATION vs FREQUENCY

**Die Characteristics**

**DIE DIMENSIONS:**

104 mils x 55 mils x 19 mils  
2650 $\mu$ m x 1400 $\mu$ m x 483 $\mu$ m

**METALLIZATION:**

Type: Al, 1% Cu  
Thickness: 16k $\text{\AA}$   $\pm$ 2k $\text{\AA}$

**PASSIVATION:**

Type: Nitride (Si<sub>3</sub>N<sub>4</sub>) over Silox (SiO<sub>2</sub>, 5% Phos.)  
Silox Thickness: 12k $\text{\AA}$   $\pm$ 2k $\text{\AA}$   
Nitride Thickness: 3.5k $\text{\AA}$   $\pm$ 1.5k $\text{\AA}$

**TRANSISTOR COUNT:**

72

**SUBSTRATE POTENTIAL (POWERED UP):**

V-

**PROCESS:**

Bipolar/JFET Dielectric Isolation

**Metallization Mask Layout**

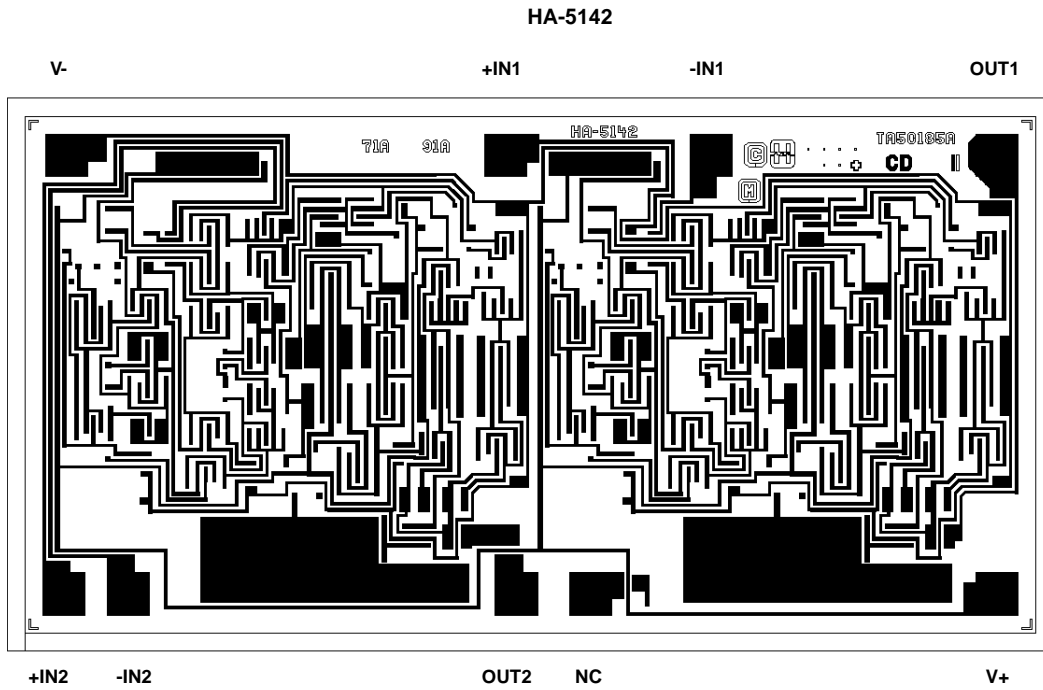



Dual-In-Line Plastic Packages (PDIP)

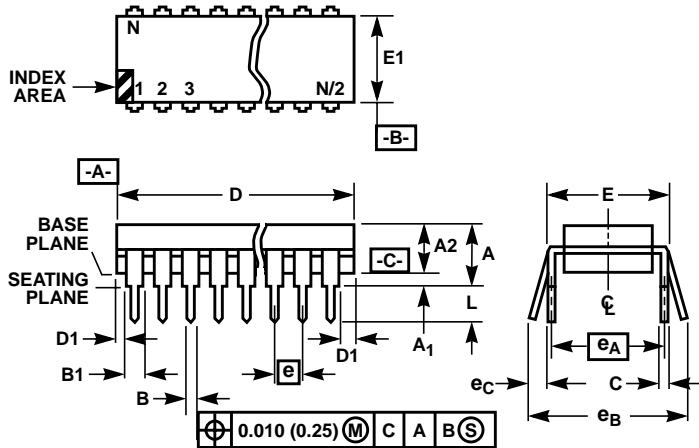

NOTES:

- Controlling Dimensions: INCH. In case of conflict between English and Metric dimensions, the inch dimensions control.
- Dimensioning and tolerancing per ANSI Y14.5M-1982.
- Symbols are defined in the "MO Series Symbol List" in Section 2.2 of Publication No. 95.
- Dimensions A, A1 and L are measured with the package seated in JEDEC seating plane gauge GS-3.
- D, D1, and E1 dimensions do not include mold flash or protrusions. Mold flash or protrusions shall not exceed 0.010 inch (0.25mm).
- E and  $e_A$  are measured with the leads constrained to be perpendicular to datum  $-C-$ .
- $e_B$  and  $e_C$  are measured at the lead tips with the leads unconstrained.  $e_C$  must be zero or greater.
- B1 maximum dimensions do not include dambar protrusions. Dambar protrusions shall not exceed 0.010 inch (0.25mm).
- N is the maximum number of terminal positions.
- Corner leads (1, N, N/2 and N/2 + 1) for E8.3, E16.3, E18.3, E28.3, E42.6 will have a B1 dimension of 0.030 - 0.045 inch (0.76 - 1.14mm).

E8.3 (JEDEC MS-001-BA ISSUE D)  
8 LEAD DUAL-IN-LINE PLASTIC PACKAGE

SYMBOL	INCHES		MILLIMETERS		NOTES
	MIN	MAX	MIN	MAX	
A	-	0.210	-	5.33	4
A1	0.015	-	0.39	-	4
A2	0.115	0.195	2.93	4.95	-
B	0.014	0.022	0.356	0.558	-
B1	0.045	0.070	1.15	1.77	8, 10
C	0.008	0.014	0.204	0.355	-
D	0.355	0.400	9.01	10.16	5
D1	0.005	-	0.13	-	5
E	0.300	0.325	7.62	8.25	6
E1	0.240	0.280	6.10	7.11	5
e	0.100 BSC		2.54 BSC		-
$e_A$	0.300 BSC		7.62 BSC		6
$e_B$	-	0.430	-	10.92	7
L	0.115	0.150	2.93	3.81	4
N	8		8		9

Rev. 0 12/93

**Ceramic Dual-In-Line Frit Seal Packages (CERDIP)**

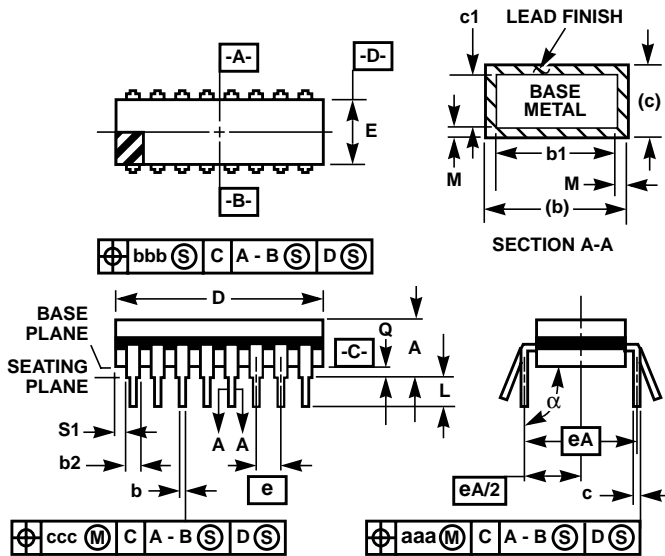

**F8.3A MIL-STD-1835 GDIP1-T8 (D-4, CONFIGURATION A)  
8 LEAD CERAMIC DUAL-IN-LINE FRIT SEAL PACKAGE**

SYMBOL	INCHES		MILLIMETERS		NOTES
	MIN	MAX	MIN	MAX	
A	-	0.200	-	5.08	-
b	0.014	0.026	0.36	0.66	2
b1	0.014	0.023	0.36	0.58	3
b2	0.045	0.065	1.14	1.65	-
b3	0.023	0.045	0.58	1.14	4
c	0.008	0.018	0.20	0.46	2
c1	0.008	0.015	0.20	0.38	3
D	-	0.405	-	10.29	5
E	0.220	0.310	5.59	7.87	5
e	0.100 BSC		2.54 BSC		-
eA	0.300 BSC		7.62 BSC		-
eA/2	0.150 BSC		3.81 BSC		-
L	0.125	0.200	3.18	5.08	-
Q	0.015	0.060	0.38	1.52	6
S1	0.005	-	0.13	-	7
alpha	90°	105°	90°	105°	-
aaa	-	0.015	-	0.38	-
bbb	-	0.030	-	0.76	-
ccc	-	0.010	-	0.25	-
M	-	0.0015	-	0.038	2, 3
N	8		8		8

Rev. 0 4/94

**NOTES:**

1. Index area: A notch or a pin one identification mark shall be located adjacent to pin one and shall be located within the shaded area shown. The manufacturer's identification shall not be used as a pin one identification mark.
2. The maximum limits of lead dimensions b and c or M shall be measured at the centroid of the finished lead surfaces, when solder dip or tin plate lead finish is applied.
3. Dimensions b1 and c1 apply to lead base metal only. Dimension M applies to lead plating and finish thickness.
4. Corner leads (1, N, N/2, and N/2+1) may be configured with a partial lead paddle. For this configuration dimension b3 replaces dimension b2.
5. This dimension allows for off-center lid, meniscus, and glass overrun.
6. Dimension Q shall be measured from the seating plane to the base plane.
7. Measure dimension S1 at all four corners.
8. N is the maximum number of terminal positions.
9. Dimensioning and tolerancing per ANSI Y14.5M - 1982.
10. Controlling dimension: INCH

All Intersil semiconductor products are manufactured, assembled and tested under **ISO9000** quality systems certification.

*Intersil semiconductor products are sold by description only. Intersil Corporation reserves the right to make changes in circuit design and/or specifications at any time without notice. Accordingly, the reader is cautioned to verify that data sheets are current before placing orders. Information furnished by Intersil is believed to be accurate and reliable. However, no responsibility is assumed by Intersil or its subsidiaries for its use; nor for any infringements of patents or other rights of third parties which may result from its use. No license is granted by implication or otherwise under any patent or patent rights of Intersil or its subsidiaries.*

For information regarding Intersil Corporation and its products, see web site [www.intersil.com](http://www.intersil.com)

**Sales Office Headquarters**

**NORTH AMERICA**  
Intersil Corporation  
P. O. Box 883, Mail Stop 53-204  
Melbourne, FL 32902  
TEL: (321) 724-7000  
FAX: (321) 724-7240

**EUROPE**  
Intersil SA  
Mercure Center  
100, Rue de la Fusee  
1130 Brussels, Belgium  
TEL: (32) 2.724.2111  
FAX: (32) 2.724.22.05

**ASIA**  
Intersil (Taiwan) Ltd.  
7F-6, No. 101 Fu Hsing North Road  
Taipei, Taiwan  
Republic of China  
TEL: (886) 2 2716 9310  
FAX: (886) 2 2715 3029