

330MHz, Low Power, Current Feedback Video Operational Amplifier

The HFA1105 is a high speed, low power current feedback amplifier built with Intersil's proprietary complementary bipolar UHF-1 process.

This amplifier features an excellent combination of low power dissipation (58mW) and high performance. The slew rate, bandwidth, and low output impedance (0.08Ω) make this amplifier a good choice for driving Flash ADCs.

Component and composite video systems also benefit from this op amp's excellent gain flatness, and good differential gain and phase specifications. The HFA1105 is ideal for interfacing to Intersil's line of video crosspoint switches (HA4201, HA4600, HA4314, HA4404, HA4344), to create high performance, low power switchers and routers.

The HFA1105 is a low power, high performance upgrade for the CLC406. For a comparable amplifier with output disable or output limiting functions, please see the data sheets for the HFA1145 and HFA1135 respectively.

For Military grade product, please refer to the HFA1145/883 data sheet.

Ordering Information

PART NUMBER (BRAND)	TEMP. RANGE (°C)	PACKAGE	PKG. DWG. #
HFA1105IB (H1105I)	-40 to 85	8 Ld SOIC	M8.15
HFA11XXEVAL (Note)	DIP Evaluation Board for High Speed Op Amps		

NOTE: Requires a SOIC-to-DIP adapter. See "Evaluation Board" section inside.

Features

- Low Supply Current 5.8mA
- High Input Impedance 1MΩ
- Wide -3dB Bandwidth. 330MHz
- Very Fast Slew Rate 1000V/μs
- Gain Flatness (to 75MHz) ±0.1dB
- Differential Gain 0.02%
- Differential Phase. 0.03 Degrees
- Pin Compatible Upgrade for CLC406

Applications

- Flash A/D Drivers
- Video Switching and Routing
- Professional Video Processing
- Video Digitizing Boards/Systems
- Multimedia Systems
- RGB Preamps
- Medical Imaging
- Hand Held and Miniaturized RF Equipment
- Battery Powered Communications

Pinout

**HFA1105 (SOIC)
TOP VIEW**

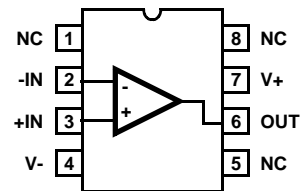

HFA1105

Absolute Maximum Ratings

Supply Voltage (V+ to V-) 11V
 DC Input Voltage V_{SUPPLY}
 Differential Input Voltage 8V
 Output Current (Note 1) Short Circuit Protected
 30mA Continuous
 60mA \leq 50% Duty Cycle
 ESD Rating >600V

Temperature Range -40°C to 85°C

Thermal Information

Thermal Resistance (Typical, Note 2) θ_{JA} (°C/W)
 SOIC Package 165
 Maximum Junction Temperature (Die) 175°C
 Maximum Junction Temperature (Plastic Package) 150°C
 Maximum Storage Temperature Range -65°C to 150°C
 Maximum Lead Temperature (Soldering 10s) 300°C
 (Lead Tips Only)

CAUTION: Stresses above those listed in "Absolute Maximum Ratings" may cause permanent damage to the device. This is a stress only rating and operation of the device at these or any other conditions above those indicated in the operational sections of this specification is not implied.

NOTES:

- Output is short circuit protected to ground. Brief short circuits to ground will not degrade reliability, however continuous (100% duty cycle) output current must not exceed 30mA for maximum reliability.
- θ_{JA} is measured with the component mounted on an evaluation PC board in free air.

Electrical Specifications $V_{SUPPLY} = \pm 5V$, $A_V = +1$, $R_F = 510W$, $R_L = 100W$, Unless Otherwise Specified

PARAMETER	TEST CONDITIONS	(NOTE 3) TEST LEVEL	TEMP. (°C)	MIN	TYP	MAX	UNITS
INPUT CHARACTERISTICS							
Input Offset Voltage		A	25	-	2	5	mV
		A	Full	-	3	8	mV
Average Input Offset Voltage Drift		B	Full	-	1	10	$\mu V/^\circ C$
Input Offset Voltage Common-Mode Rejection Ratio	$\Delta V_{CM} = \pm 1.8V$	A	25	47	50	-	dB
	$\Delta V_{CM} = \pm 1.8V$	A	85	45	48	-	dB
	$\Delta V_{CM} = \pm 1.2V$	A	-40	45	48	-	dB
Input Offset Voltage Power Supply Rejection Ratio	$\Delta V_{PS} = \pm 1.8V$	A	25	50	54	-	dB
	$\Delta V_{PS} = \pm 1.8V$	A	85	47	50	-	dB
	$\Delta V_{PS} = \pm 1.2V$	A	-40	47	50	-	dB
Non-Inverting Input Bias Current		A	25	-	6	15	μA
		A	Full	-	10	25	μA
Non-Inverting Input Bias Current Drift		B	Full	-	5	60	$nA/^\circ C$
Non-Inverting Input Bias Current Power Supply Sensitivity	$\Delta V_{PS} = \pm 1.8V$	A	25	-	0.5	1	$\mu A/V$
	$\Delta V_{PS} = \pm 1.8V$	A	85	-	0.8	3	$\mu A/V$
	$\Delta V_{PS} = \pm 1.2V$	A	-40	-	0.8	3	$\mu A/V$
Non-Inverting Input Resistance	$\Delta V_{CM} = \pm 1.8V$	A	25	0.8	1.2	-	$M\Omega$
	$\Delta V_{CM} = \pm 1.8V$	A	85	0.5	0.8	-	$M\Omega$
	$\Delta V_{CM} = \pm 1.2V$	A	-40	0.5	0.8	-	$M\Omega$
Inverting Input Bias Current		A	25	-	2	7.5	μA
		A	Full	-	5	15	μA
Inverting Input Bias Current Drift		B	Full	-	60	200	$nA/^\circ C$
Inverting Input Bias Current Common-Mode Sensitivity	$\Delta V_{CM} = \pm 1.8V$	A	25	-	3	6	$\mu A/V$
	$\Delta V_{CM} = \pm 1.8V$	A	85	-	4	8	$\mu A/V$
	$\Delta V_{CM} = \pm 1.2V$	A	-40	-	4	8	$\mu A/V$
Inverting Input Bias Current Power Supply Sensitivity	$\Delta V_{PS} = \pm 1.8V$	A	25	-	2	5	$\mu A/V$
	$\Delta V_{PS} = \pm 1.8V$	A	85	-	4	8	$\mu A/V$
	$\Delta V_{PS} = \pm 1.2V$	A	-40	-	4	8	$\mu A/V$

HFA1105

Electrical Specifications $V_{SUPPLY} = \pm 5V$, $A_V = +1$, $R_F = 510\Omega$, $R_L = 100\Omega$, Unless Otherwise Specified (Continued)

PARAMETER	TEST CONDITIONS	(NOTE 3) TEST LEVEL	TEMP. (°C)	MIN	TYP	MAX	UNITS
Inverting Input Resistance		C	25	-	60	-	Ω
Input Capacitance		C	25	-	1.6	-	pF
Input Voltage Common Mode Range (Implied by V_{IO} CMRR, $+R_{IN}$, and $-BIAS$ CMS Tests)		A	25, 85	± 1.8	± 2.4	-	V
		A	-40	± 1.2	± 1.7	-	V
Input Noise Voltage Density (Note 6)	$f = 100\text{kHz}$	B	25	-	3.5	-	$\text{nV}/\sqrt{\text{Hz}}$
Non-Inverting Input Noise Current Density (Note 6)	$f = 100\text{kHz}$	B	25	-	2.5	-	$\text{pA}/\sqrt{\text{Hz}}$
Inverting Input Noise Current Density (Note 6)	$f = 100\text{kHz}$	B	25	-	20	-	$\text{pA}/\sqrt{\text{Hz}}$
TRANSFER CHARACTERISTICS							
Open Loop Transimpedance Gain	$A_V = -1$	C	25	-	500	-	$\text{k}\Omega$
AC CHARACTERISTICS $R_F = 510\Omega$, Unless Otherwise Specified							
-3dB Bandwidth ($V_{OUT} = 0.2V_{P-P}$, Note 6)	$A_V = +1$, $+R_S = 510\Omega$	B	25	-	270	-	MHz
		B	Full	-	240	-	MHz
	$A_V = -1$, $R_F = 425\Omega$	B	25	-	300	-	MHz
		B	Full	-	260	-	MHz
	$A_V = +2$	B	25	-	330	-	MHz
		B	Full	-	260	-	MHz
$A_V = +10$, $R_F = 180\Omega$	B	25	-	130	-	MHz	
	B	Full	-	90	-	MHz	
Full Power Bandwidth ($V_{OUT} = 5V_{P-P}$ at $A_V = +2/-1$, $4V_{P-P}$ at $A_V = +1$, Note 6)	$A_V = +1$, $+R_S = 510\Omega$	B	25	-	135	-	MHz
	$A_V = -1$	B	25	-	140	-	MHz
	$A_V = +2$	B	25	-	115	-	MHz
Gain Flatness ($A_V = +2$, $V_{OUT} = 0.2V_{P-P}$, Note 6)	To 25MHz	B	25	-	± 0.03	-	dB
		B	Full	-	± 0.04	-	dB
	To 75MHz	B	25	-	± 0.11	-	dB
		B	Full	-	± 0.22	-	dB
Gain Flatness ($A_V = +1$, $+R_S = 510\Omega$, $V_{OUT} = 0.2V_{P-P}$, Note 6)	To 25MHz	B	25	-	± 0.03	-	dB
	To 75MHz	B	25	-	± 0.09	-	dB
Minimum Stable gain		A	Full	-	1	-	V/V
OUTPUT CHARACTERISTICS $A_V = +2$, $R_F = 510\Omega$, Unless Otherwise Specified							
Output Voltage Swing (Note 6)	$A_V = -1$, $R_L = 100\Omega$	A	25	± 3	± 3.4	-	V
		A	Full	± 2.8	± 3	-	V
Output Current (Note 6)	$A_V = -1$, $R_L = 50\Omega$	A	25, 85	50	60	-	mA
		A	-40	28	42	-	mA
Output Short Circuit Current		B	25	-	90	-	mA
Closed Loop Output Impedance (Note 6)	DC	B	25	-	0.08	-	Ω
Second Harmonic Distortion ($V_{OUT} = 2V_{P-P}$, Note 6)	10MHz	B	25	-	-48	-	dBc
	20MHz	B	25	-	-44	-	dBc
Third Harmonic Distortion ($V_{OUT} = 2V_{P-P}$, Note 6)	10MHz	B	25	-	-50	-	dBc
	20MHz	B	25	-	-45	-	dBc
Reverse Isolation (S_{12} , Note 6)	30MHz	B	25	-	-55	-	dB

HFA1105

Electrical Specifications $V_{SUPPLY} = \pm 5V$, $A_V = +1$, $R_F = 510\Omega$, $R_L = 100W$, Unless Otherwise Specified (Continued)

PARAMETER	TEST CONDITIONS	(NOTE 3) TEST LEVEL	TEMP. (°C)	MIN	TYP	MAX	UNITS
TRANSIENT CHARACTERISTICS $A_V = +2$, $R_F = 510\Omega$, Unless Otherwise Specified							
Rise and Fall Times	$V_{OUT} = 0.5V_{P-P}$	B	25	-	1.1	-	ns
		B	Full	-	1.4	-	ns
Overshoot (Note 4) ($V_{OUT} = 0$ to $0.5V$, V_{IN} $t_{RISE} = 1ns$)	+OS	B	25	-	3	-	%
	-OS	B	25	-	5	-	%
Overshoot (Note 4) ($V_{OUT} = 0.5V_{P-P}$, V_{IN} $t_{RISE} = 1ns$)	+OS	B	25	-	3	-	%
	-OS	B	25	-	11	-	%
Slew Rate ($V_{OUT} = 4V_{P-P}$, $A_V = +1$, $+R_S = 510\Omega$)	+SR	B	25	-	1000	-	V/ μs
		B	Full	-	975	-	V/ μs
	-SR (Note 5)	B	25	-	650	-	V/ μs
		B	Full	-	580	-	V/ μs
Slew Rate ($V_{OUT} = 5V_{P-P}$, $A_V = +2$)	+SR	B	25	-	1400	-	V/ μs
		B	Full	-	1200	-	V/ μs
	-SR (Note 5)	B	25	-	800	-	V/ μs
		B	Full	-	700	-	V/ μs
Slew Rate ($V_{OUT} = 5V_{P-P}$, $A_V = -1$)	+SR	B	25	-	2100	-	V/ μs
		B	Full	-	1900	-	V/ μs
	-SR (Note 5)	B	25	-	1000	-	V/ μs
		B	Full	-	900	-	V/ μs
Settling Time ($V_{OUT} = +2V$ to $0V$ step, Note 6)	To 0.1%	B	25	-	15	-	ns
	To 0.05%	B	25	-	23	-	ns
	To 0.02%	B	25	-	30	-	ns
Overdrive Recovery Time	$V_{IN} = \pm 2V$	B	25	-	8.5	-	ns
VIDEO CHARACTERISTICS $A_V = +2$, $R_F = 510\Omega$, Unless Otherwise Specified							
Differential Gain ($f = 3.58MHz$)	$R_L = 150\Omega$	B	25	-	0.02	-	%
	$R_L = 75\Omega$	B	25	-	0.03	-	%
Differential Phase ($f = 3.58MHz$)	$R_L = 150\Omega$	B	25	-	0.03	-	Degrees
	$R_L = 75\Omega$	B	25	-	0.05	-	Degrees
POWER SUPPLY CHARACTERISTICS							
Power Supply Range		C	25	± 4.5	-	± 5.5	V
Power Supply Current (Note 6)		A	25	-	5.8	6.1	mA
		A	Full	-	5.9	6.3	mA

NOTES:

- Test Level: A. Production Tested; B. Typical or Guaranteed Limit Based on Characterization; C. Design Typical for Information Only.
- Undershoot dominates for output signal swings below GND (e.g., $0.5V_{P-P}$), yielding a higher overshoot limit compared to the $V_{OUT} = 0$ to $0.5V$ condition. See the "Application Information" section for details.
- Slew rates are asymmetrical if the output swings below GND (e.g. a bipolar signal). Positive unipolar output signals have symmetric positive and negative slew rates comparable to the +SR specification. See the "Application Information" section, and the pulse response graphs for details.
- See Typical Performance Curves for more information.

Application Information

Optimum Feedback Resistor

Although a current feedback amplifier's bandwidth dependency on closed loop gain isn't as severe as that of a voltage feedback amplifier, there can be an appreciable decrease in bandwidth at higher gains. This decrease may be minimized by taking advantage of the current feedback amplifier's unique relationship between bandwidth and R_F . All current feedback amplifiers require a feedback resistor, even for unity gain applications, and R_F , in conjunction with the internal compensation capacitor, sets the dominant pole of the frequency response. Thus, the amplifier's bandwidth is inversely proportional to R_F . The HFA1105 design is optimized for $R_F = 510\Omega$ at a gain of +2. Decreasing R_F decreases stability, resulting in excessive peaking and overshoot (Note: Capacitive feedback will cause the same problems due to the feedback impedance decrease at higher frequencies). At higher gains, however, the amplifier is more stable so R_F can be decreased in a trade-off of stability for bandwidth.

The table below lists recommended R_F values for various gains, and the expected bandwidth. For a gain of +1, a resistor (+ R_S) in series with +IN is required to reduce gain peaking and increase stability.

GAIN (ACL)	R_F (Ω)	BANDWIDTH (MHz)
-1	425	300
+1	510 (+ $R_S = 510\Omega$)	270
+2	510	330
+5	200	300
+10	180	130

Non-Inverting Input Source Impedance

For best operation, the DC source impedance seen by the non-inverting input should be $\geq 50\Omega$. This is especially important in inverting gain configurations where the non-inverting input would normally be connected directly to GND.

Pulse Undershoot and Asymmetrical Slew Rates

The HFA1105 utilizes a quasi-complementary output stage to achieve high output current while minimizing quiescent supply current. In this approach, a composite device replaces the traditional PNP pulldown transistor. The composite device switches modes after crossing 0V, resulting in added distortion for signals swinging below ground, and an increased undershoot on the negative portion of the output waveform (See Figures 5, 8, and 11). This undershoot isn't present for small bipolar signals, or large positive signals. Another artifact of the composite device is asymmetrical slew rates for output signals with a negative voltage component. The slew rate degrades as the output signal crosses through 0V (See Figures 5, 8, and 11), resulting in a slower overall

negative slew rate. Positive only signals have symmetrical slew rates as illustrated in the large signal positive pulse response graphs (See Figures 4, 7, and 10).

PC Board Layout

The amplifier's frequency response depends greatly on the care taken in designing the PC board. **The use of low inductance components such as chip resistors and chip capacitors is strongly recommended, while a solid ground plane is a must!**

Attention should be given to decoupling the power supplies. A large value (10 μ F) tantalum in parallel with a small value (0.1 μ F) chip capacitor works well in most cases.

Terminated microstrip signal lines are recommended at the device's input and output connections. Capacitance, parasitic or planned, connected to the output must be minimized, or isolated as discussed in the next section.

Care must also be taken to minimize the capacitance to ground at the amplifier's inverting input (-IN), as this capacitance causes gain peaking, pulse overshoot, and if large enough, instability. To reduce this capacitance, the designer should remove the ground plane under traces connected to

-IN, and keep connections to -IN as short as possible.

An example of a good high frequency layout is the Evaluation Board shown in Figure 2.

Driving Capacitive Loads

Capacitive loads, such as an A/D input, or an improperly terminated transmission line will degrade the amplifier's phase margin resulting in frequency response peaking and possible oscillations. In most cases, the oscillation can be avoided by placing a resistor (R_S) in series with the output prior to the capacitance.

Figure 1 details starting points for the selection of this resistor. The points on the curve indicate the R_S and C_L combinations for the optimum bandwidth, stability, and settling time, but experimental fine tuning is recommended. Picking a point above or to the right of the curve yields an overdamped response, while points below or left of the curve indicate areas of underdamped performance.

R_S and C_L form a low pass network at the output, thus limiting system bandwidth well below the amplifier bandwidth of 270MHz (for $A_V = +1$). By decreasing R_S as C_L increases (as illustrated in the curves), the maximum bandwidth is obtained without sacrificing stability. In spite of this, the bandwidth decreases as the load capacitance increases. For example, at $A_V = +1$, $R_S = 62\Omega$, $C_L = 40pF$, the overall bandwidth is limited to 180MHz, and bandwidth drops to 75MHz at $A_V = +1$, $R_S = 8\Omega$, $C_L = 400pF$.

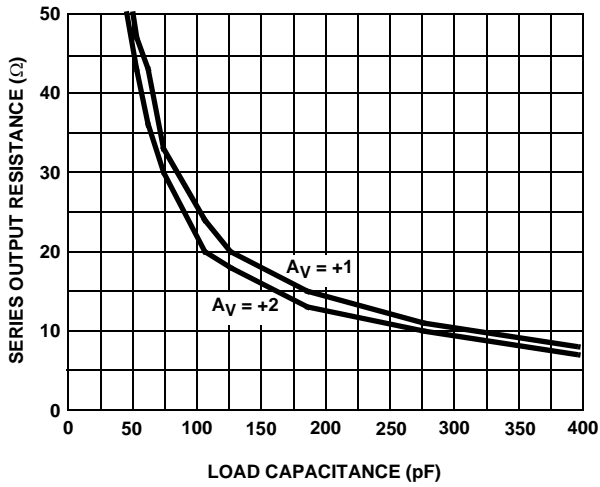

FIGURE 1. RECOMMENDED SERIES OUTPUT RESISTOR vs LOAD CAPACITANCE

Evaluation Board

The performance of the HFA1105 may be evaluated using the HFA11XX Evaluation Board and a SOIC to DIP adaptor like the Aries Electronics Part Number 14-350000-10.

The layout and schematic of the board are shown in Figure 2. To order evaluation boards (part number HFA11XXEVAL), please contact your local sales office.

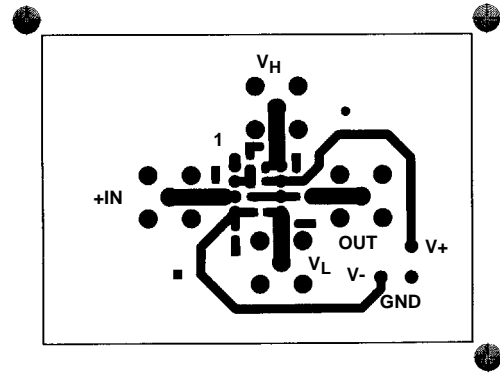

FIGURE 2A. TOP LAYOUT

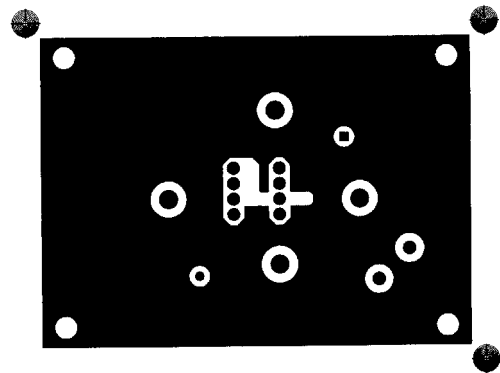

FIGURE 2B. BOTTOM LAYOUT

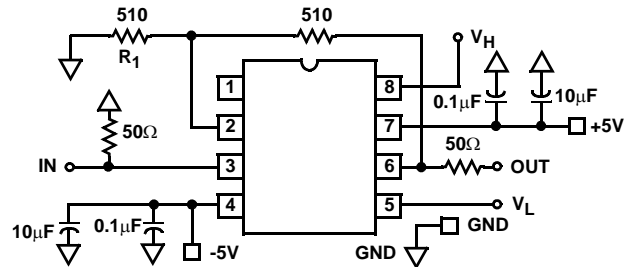

FIGURE 2C. SCHEMATIC

FIGURE 2. EVALUATION BOARD SCHEMATIC AND LAYOUT

Typical Performance Curves $V_{SUPPLY} = \pm 5V$, $R_F = 510\Omega$, $T_A = 25^\circ C$, $R_L = 100\Omega$, Unless Otherwise Specified

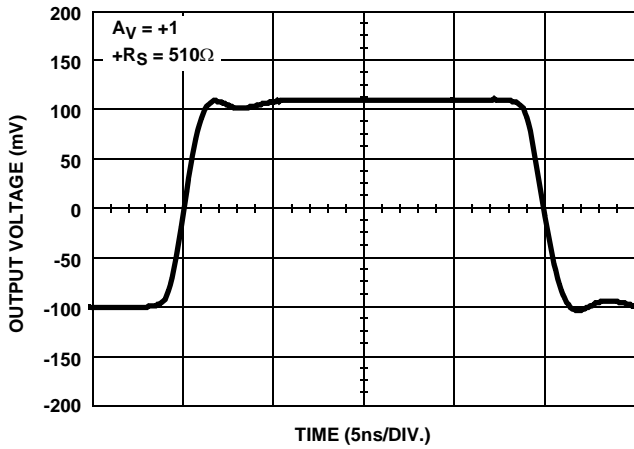

FIGURE 3. SMALL SIGNAL PULSE RESPONSE

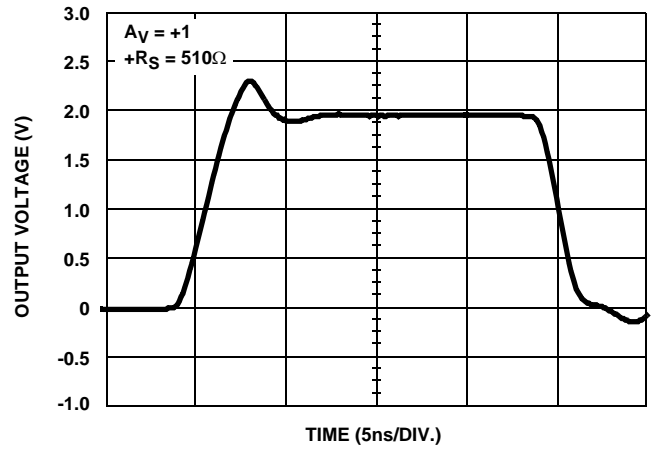

FIGURE 4. LARGE SIGNAL POSITIVE PULSE RESPONSE

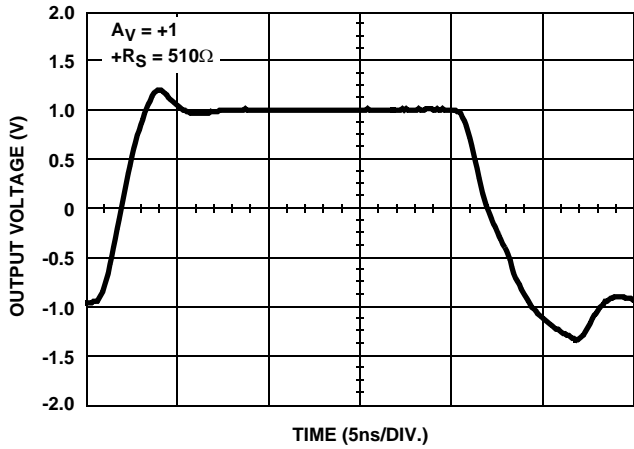

FIGURE 5. LARGE SIGNAL BIPOLAR PULSE RESPONSE

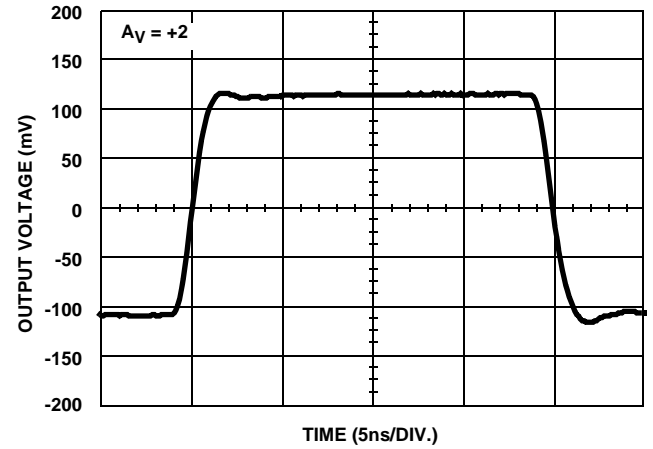

FIGURE 6. SMALL SIGNAL PULSE RESPONSE

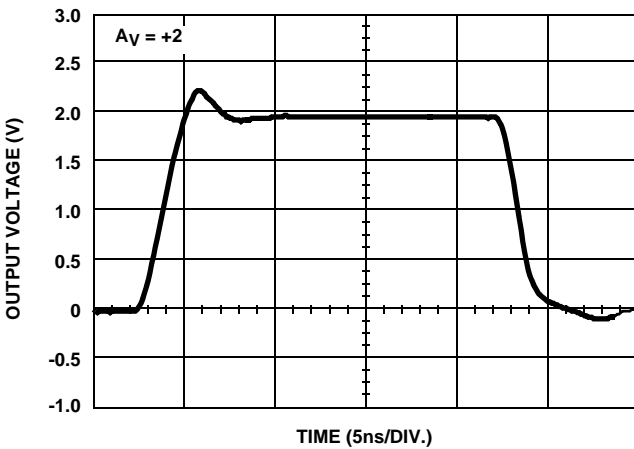

FIGURE 7. LARGE SIGNAL POSITIVE PULSE RESPONSE

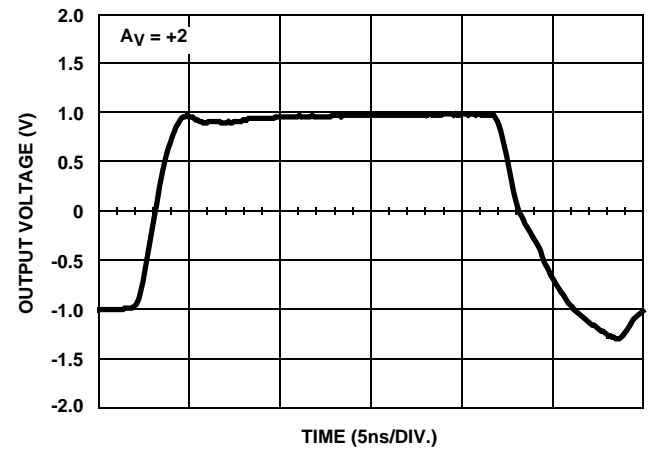

FIGURE 8. LARGE SIGNAL BIPOLAR PULSE RESPONSE

Typical Performance Curves $V_{SUPPLY} = \pm 5V$, $R_F = 510\Omega$, $T_A = 25^\circ C$, $R_L = 100\Omega$, Unless Otherwise Specified (Continued)

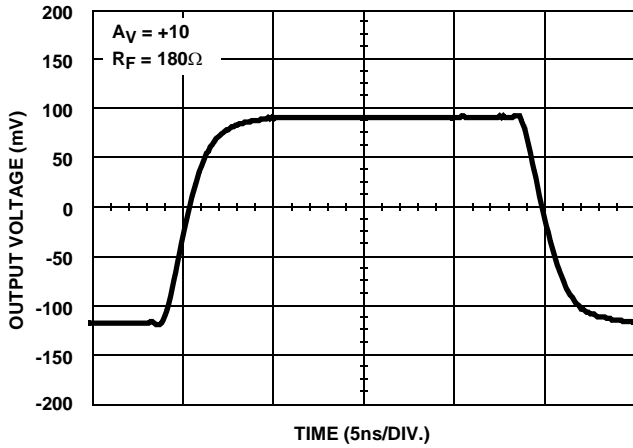

FIGURE 9. SMALL SIGNAL PULSE RESPONSE

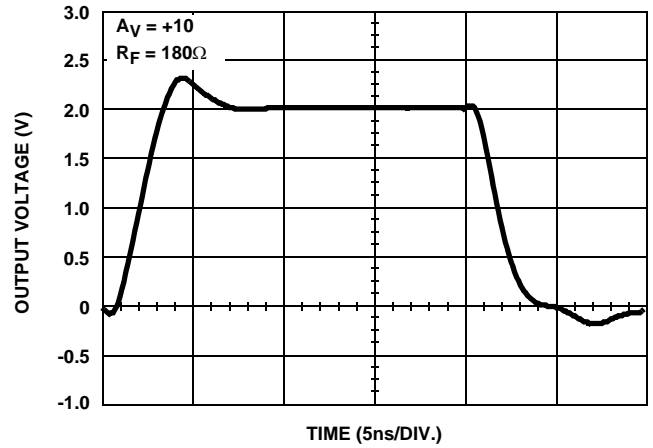

FIGURE 10. LARGE SIGNAL POSITIVE PULSE RESPONSE

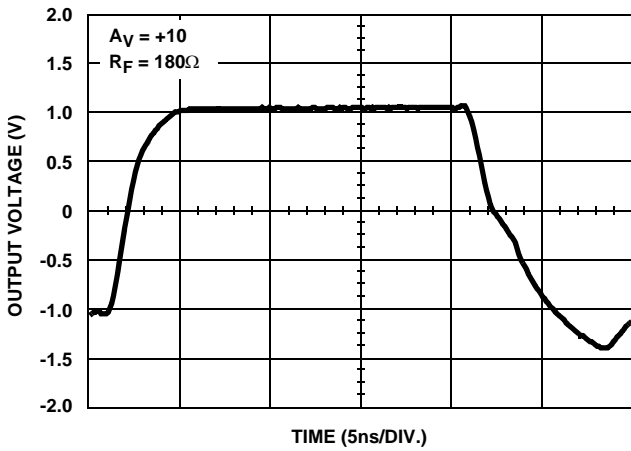

FIGURE 11. LARGE SIGNAL BIPOLAR PULSE RESPONSE

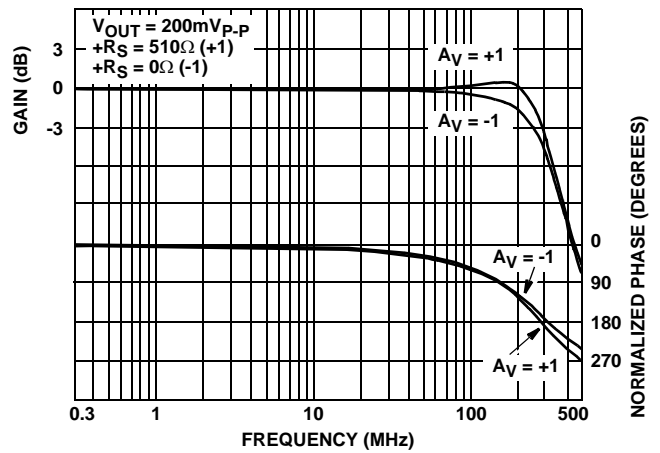

FIGURE 12. FREQUENCY RESPONSE

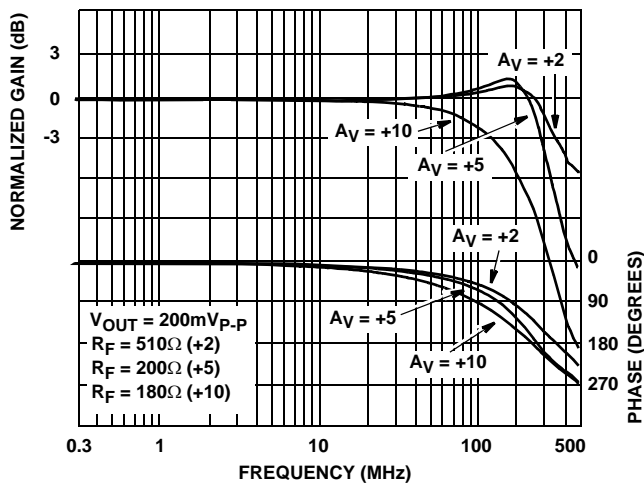

FIGURE 13. FREQUENCY RESPONSE

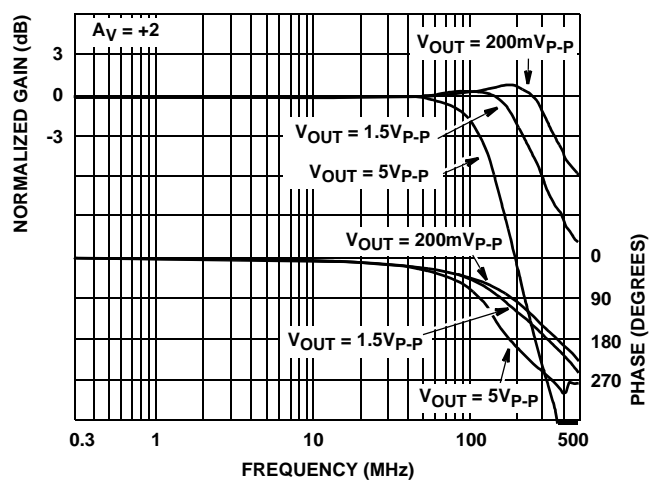

FIGURE 14. FREQUENCY RESPONSE FOR VARIOUS OUTPUT VOLTAGES

Typical Performance Curves $V_{SUPPLY} = \pm 5V$, $R_F = 510\Omega$, $T_A = 25^\circ C$, $R_L = 100\Omega$, Unless Otherwise Specified (Continued)

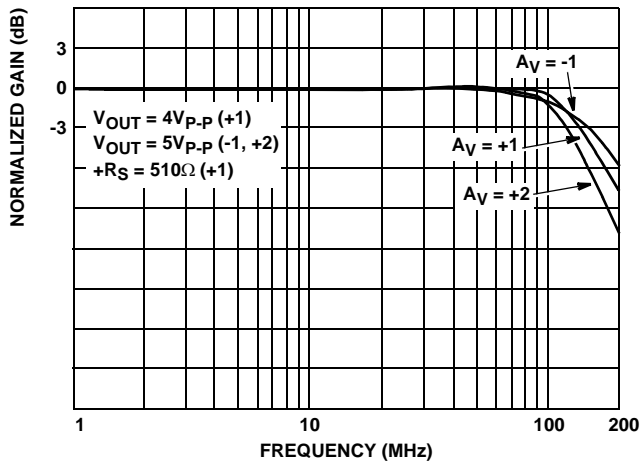

FIGURE 15. FULL POWER BANDWIDTH

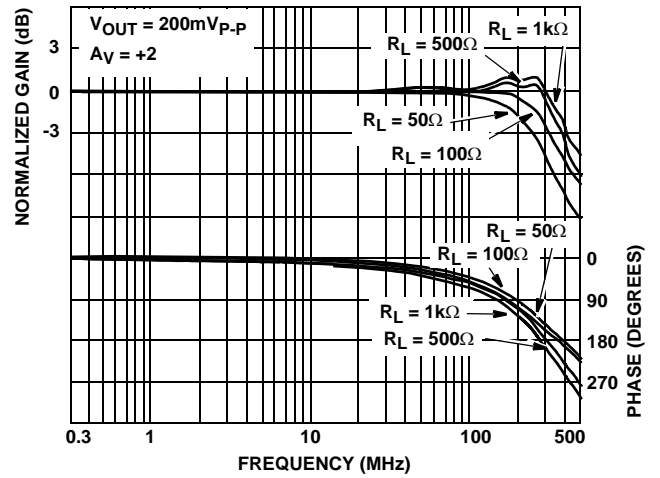

FIGURE 16. FREQUENCY RESPONSE FOR VARIOUS LOAD RESISTORS

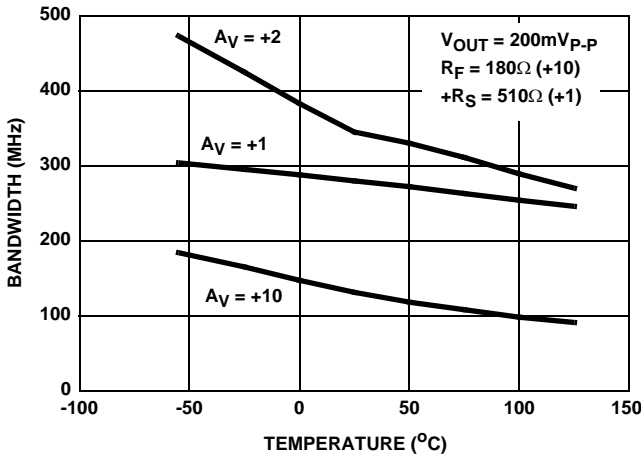

FIGURE 17. -3dB BANDWIDTH vs TEMPERATURE

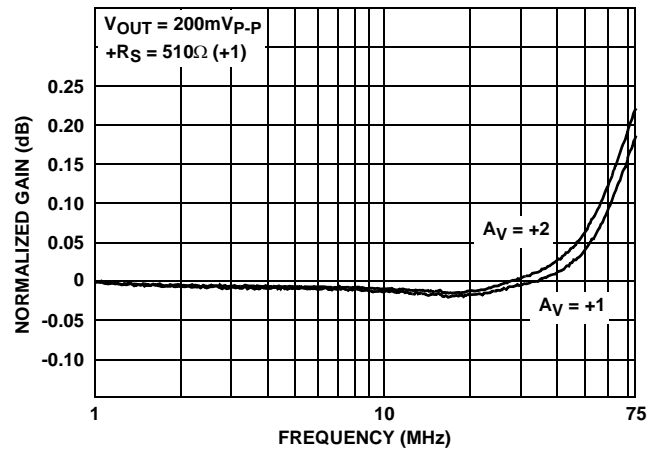

FIGURE 18. GAIN FLATNESS

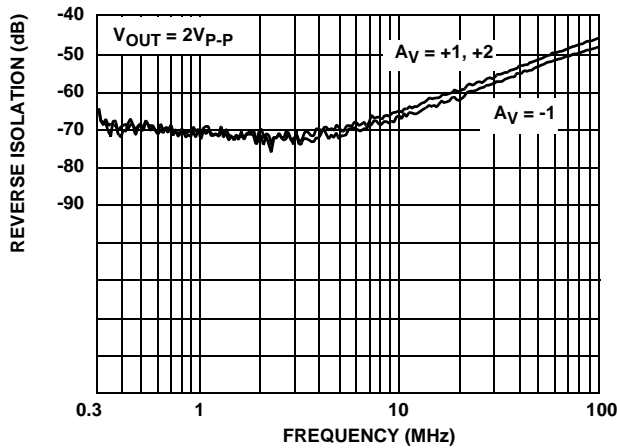

FIGURE 19. REVERSE ISOLATION

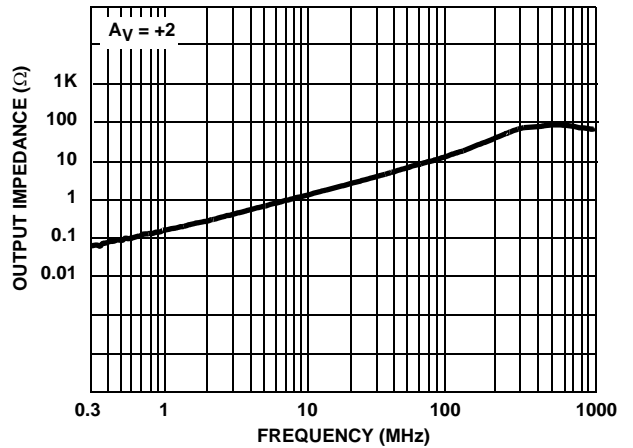

FIGURE 20. OUTPUT IMPEDANCE

Typical Performance Curves $V_{SUPPLY} = \pm 5V$, $R_F = 510\Omega$, $T_A = 25^\circ C$, $R_L = 100\Omega$, Unless Otherwise Specified (Continued)

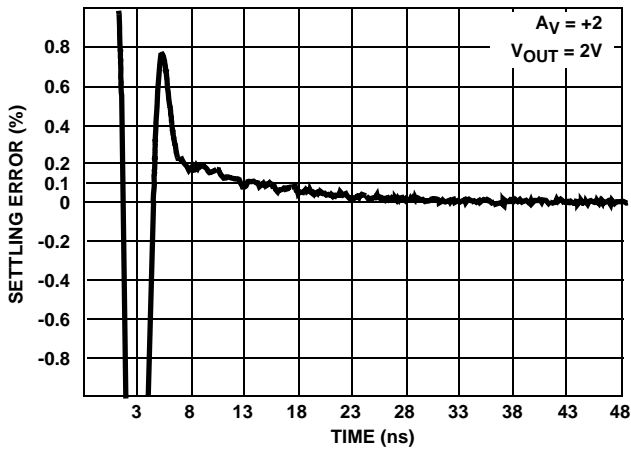

FIGURE 21. SETTLING RESPONSE

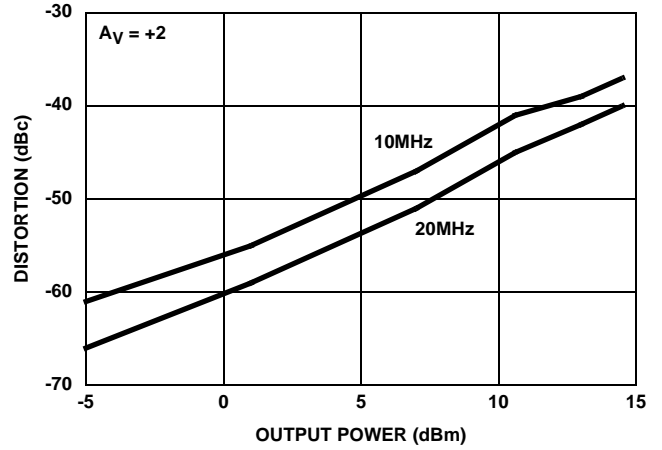

FIGURE 22. SECOND HARMONIC DISTORTION vs P_{OUT}

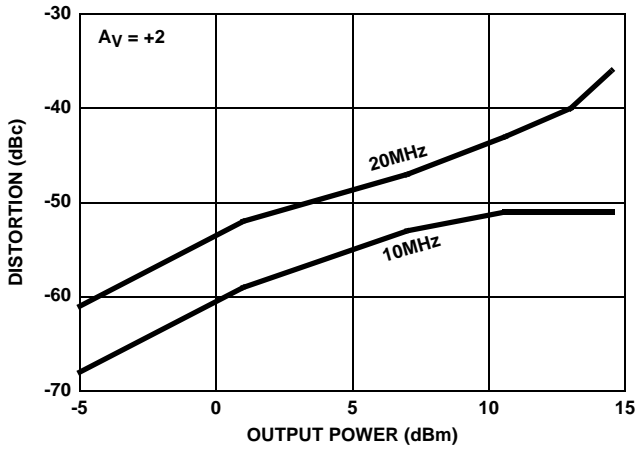

FIGURE 23. THIRD HARMONIC DISTORTION vs P_{OUT}

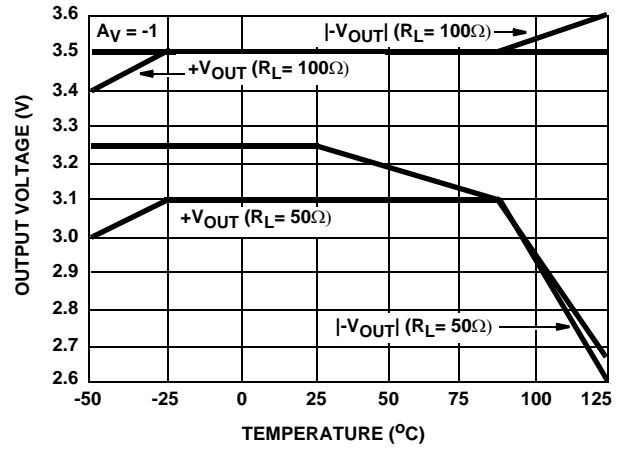

FIGURE 24. OUTPUT VOLTAGE vs TEMPERATURE

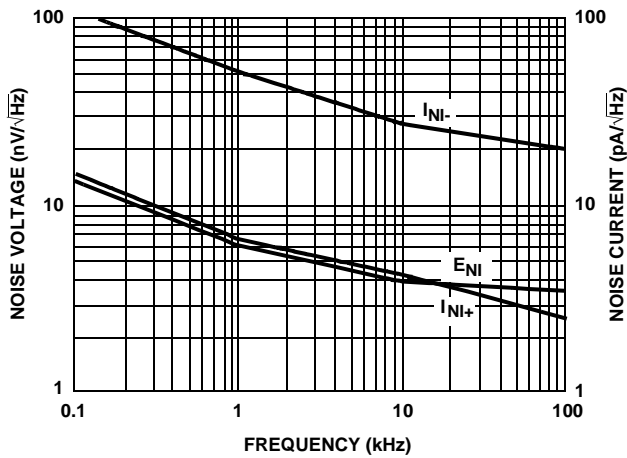

FIGURE 25. INPUT NOISE CHARACTERISTICS

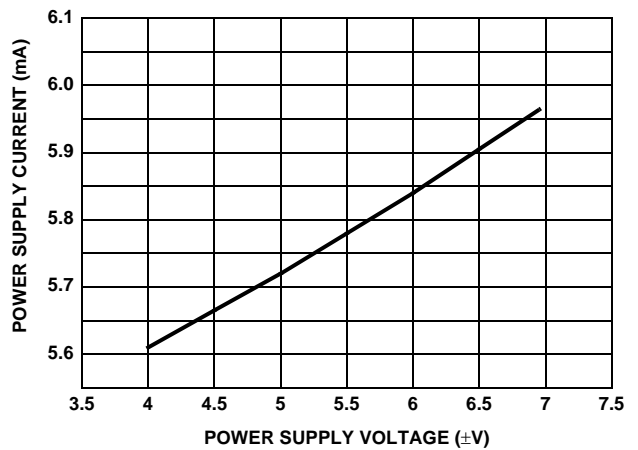

FIGURE 26. SUPPLY CURRENT vs SUPPLY VOLTAGE

Die Characteristics

DIE DIMENSIONS:

59 mils x 59 mils x 19 mils
1500µm x 1500µm x 483µm

METALLIZATION:

Type: Metal 1: AlCu(2%)/TiW
Thickness: Metal 1: 8kÅ ±0.4kÅ
Type: Metal 2: AlCu(2%)
Thickness: Metal 2: 16kÅ ±0.8kÅ

PASSIVATION:

Type: Nitride
Thickness: 4kÅ ±0.5kÅ

TRANSISTOR COUNT:

75

SUBSTRATE POTENTIAL (POWERED UP):

Floating (Recommend Connection to V-)

Metallization Mask Layout

HFA1105

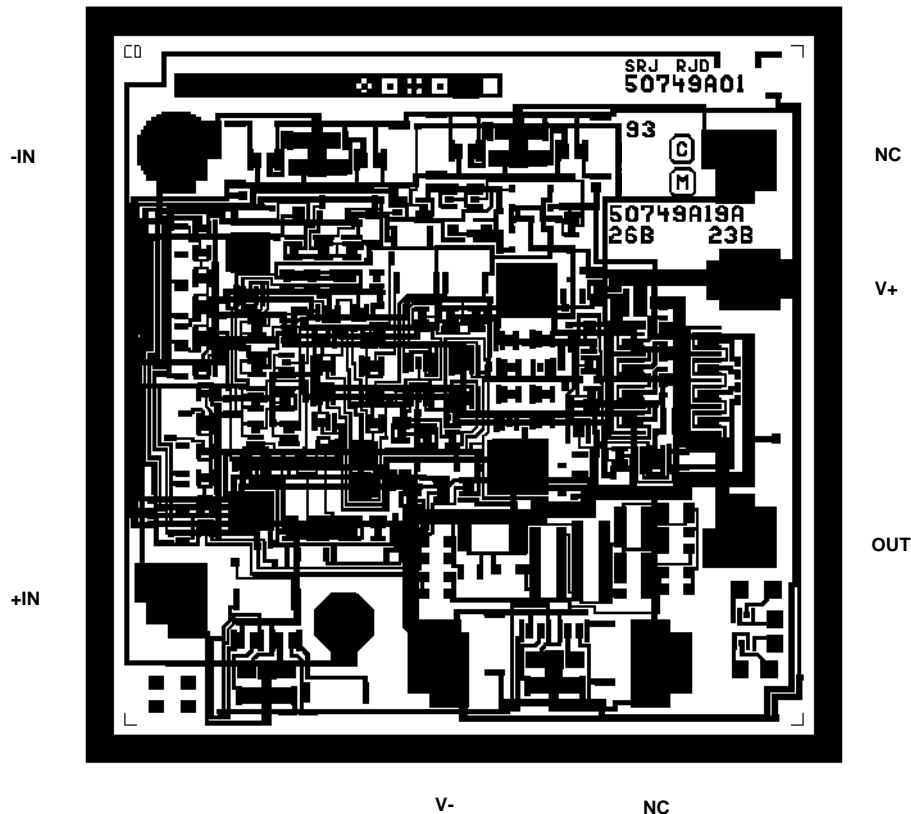

All Intersil U.S. products are manufactured, assembled and tested utilizing ISO9000 quality systems. Intersil Corporation's quality certifications can be viewed at www.intersil.com/design/quality

Intersil products are sold by description only. Intersil Corporation reserves the right to make changes in circuit design, software and/or specifications at any time without notice. Accordingly, the reader is cautioned to verify that data sheets are current before placing orders. Information furnished by Intersil is believed to be accurate and reliable. However, no responsibility is assumed by Intersil or its subsidiaries for its use; nor for any infringements of patents or other rights of third parties which may result from its use. No license is granted by implication or otherwise under any patent or patent rights of Intersil or its subsidiaries.

For information regarding Intersil Corporation and its products, see www.intersil.com