

52A, 30V, 0.019 Ohm, N-Channel Logic Level, Power MOSFETs

These are N-Channel enhancement mode silicon gate power field effect transistors. They are advanced power MOSFETs designed, tested, and guaranteed to withstand a specified level of energy in the breakdown avalanche mode of operation. All of these power MOSFETs are designed for applications such as switching regulators, switching converters, motor drivers, relay drivers, and drivers for high power bipolar switching transistors requiring high speed and low gate drive power. These types can be operated directly from integrated circuits.

Ordering Information

PART NUMBER	PACKAGE	BRAND
HPLU3103	TO-251AA	HP3103
HPLR3103	TO-252AA	HP3103

NOTE: When ordering, use the entire part number. Add the suffix T to obtain the TO-252AA variant in tape and reel, e.g., HPLR3103T.

Features

- Logic Level Gate Drive
- 52A†, 30V
- Low On-Resistance, $r_{DS(ON)} = 0.019\Omega$
- UIS Rating Curve
- Related Literature
 - TB334, "Guidelines for Soldering Surface Mount Components to PC Boards"

† Calculated continuous current based on maximum allowable junction temperature. Package limited to 20A continuous, see Figure 9.

Symbol

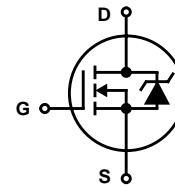

Packaging

JEDEC TO-251AA

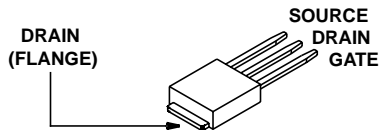

JEDEC TO-252AA

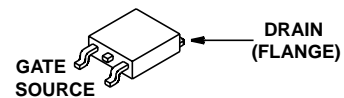

HPLR3103, HPLU3103

Absolute Maximum Ratings $T_C = 25^\circ\text{C}$, Unless Otherwise Specified

	HPLR3103, HPLU3103	UNITS
Drain to Source Voltage (Note 1)	V_{DSS}	30 V
Drain to Gate Voltage ($R_{GS} = 20k\Omega$) (Note 1)	V_{DGR}	30 V
Gate to Source Voltage	V_{GS}	$\pm 16V$
Continuous Drain Current	I_D	52 A
Pulsed Drain Current (Note 2)	I_{DM}	390 A
Single Pulse Avalanche Energy (Note 4)	E_{AS}	240 mj
Power Dissipation	P_D	89 W
Derate Above 25°C		0.71 $W/^\circ\text{C}$
Operating and Storage Temperature	T_J, T_{STG}	-55 to 150 $^\circ\text{C}$
Maximum Temperature for Soldering		
Leads at 0.063in (1.6mm) from Case for 10s	T_L	300 $^\circ\text{C}$
Package Body for 10s, See Techbrief 334	T_{pkg}	260 $^\circ\text{C}$

CAUTION: Stresses above those listed in "Absolute Maximum Ratings" may cause permanent damage to the device. This is a stress only rating and operation of the device at these or any other conditions above those indicated in the operational sections of this specification is not implied.

NOTE:

- $T_J = 25^\circ\text{C}$ to 125°C .

Electrical Specifications $T_C = 25^\circ\text{C}$, Unless Otherwise Specified

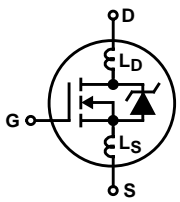
PARAMETER	SYMBOL	TEST CONDITIONS	MIN	TYP	MAX	UNITS	
Drain to Source Breakdown Voltage	BV_{DSS}	$I_D = 250\mu\text{A}, V_{GS} = 0V$	30	-	-	V	
Gate to Source Threshold Voltage	$V_{GS(TH)}$	$V_{GS} = V_{DS}, I_D = 250\mu\text{A}$	1	-	-	V	
Zero Gate Voltage Drain Current	I_{DSS}	$V_{DS} = 30V, V_{GS} = 0V$	-	-	25	μA	
		$V_{DS} = 24V, V_{GS} = 0V, T_C = 125^\circ\text{C}$	-	-	250	μA	
Gate to Source Leakage Current	I_{GSS}	$V_{GS} = \pm 16V$	-	-	100	nA	
Breakdown Voltage Temperature Coefficient	$\Delta V_{(BR)DSS} / \Delta T_J$	Reference to $25^\circ\text{C}, I_D = 1\text{mA}$	-	0.037	-	V	
Drain to Source On Resistance (Note 3)	$r_{DS(ON)}$	$I_D = 28A, V_{GS} = 10V$	-	-	0.019	Ω	
		$I_D = 23A, V_{GS} = 4.5V$	-	-	0.024	Ω	
Turn-On Delay Time	$t_{d(ON)}$	$V_{DD} = 15V, I_D \cong 34A, R_L = 0.441\Omega, V_{GS} = 4.5V, R_{GS} = 3.4\Omega, I_{g(REF)} = 3\text{mA}$	-	9	-	ns	
Rise Time	t_r		-	210	-	ns	
Turn-Off Delay Time (Note 3)	$t_{d(OFF)}$		-	20	-	ns	
Fall Time	t_f		-	54	-	ns	
Total Gate Charge	Q_g	$V_{DD} = 24V, I_D \cong 34A, V_{GS} = 4.5V$ (Figure 6)	-	-	50	nC	
Gate to Source Charge	Q_{gs}		-	-	14	nC	
Gate to Drain "Miller" Charge	Q_{gd}		-	-	28	nC	
Input Capacitance	C_{ISS}	$V_{DS} = 25V, V_{GS} = 0V, f = 1\text{MHz}$ (Figure 5)	-	1600	-	pF	
Output Capacitance	C_{OSS}		-	640	-	pF	
Reverse Transfer Capacitance	C_{RSS}		-	320	-	pF	
Internal Source Inductance	L_S	Measured From the Source Lead, 6mm (0.25in) From Package to Center of Die	Modified MOSFET Symbol Showing the Internal Devices Inductances		-	7.5	nH
Internal Drain Inductance	L_D	Measured From the Drain-Lead, 6mm (0.25in) From Package to Center of Die			-	4.5	nH

HPLR3103, HPLU3103

Electrical Specifications $T_C = 25^\circ\text{C}$, Unless Otherwise Specified

PARAMETER	SYMBOL	TEST CONDITIONS	MIN	TYP	MAX	UNITS
Thermal Resistance Junction to Case	$R_{\theta JC}$		-	-	1.4	$^\circ\text{C/W}$
Thermal Resistance Junction to Ambient	$R_{\theta JA}$		-	-	110	$^\circ\text{C/W}$
		(PCB Mount Steady State)	-	-	50	$^\circ\text{C/W}$

Source to Drain Diode Specifications

PARAMETER	SYMBOL	TEST CONDITIONS	MIN	TYP	MAX	UNITS
Continuous Source to Drain Current	I_{SD}	MOSFET Symbol Showing The Integral Reverse P-N Junction Diode	-	-	52 (Note 1)	A
Pulsed Source to Drain Current (Note 2)	I_{SDM}		-	-	220	A
Source to Drain Diode Voltage (Note 3)	V_{SD}	$I_{SD} = 28\text{A}$	-	-	1.3	V
Reverse Recovery Time (Note 3)	t_{rr}	$I_{SD} = 34\text{A}$, $dI_{SD}/dt = 100\text{A}/\mu\text{s}$	-	81	120	ns
Reverse Recovered Charge (Note 3)	Q_{RR}	$I_{SD} = 34\text{A}$, $dI_{SD}/dt = 100\text{A}/\mu\text{s}$	-	210	310	nC

NOTES:

2. Repetitive rating; pulse width limited by maximum junction temperature (See Figure 11).
3. Pulse width $\leq 300\mu\text{s}$; duty cycle $\leq 2\%$.
4. $V_{DD} = 15\text{V}$, starting $T_J = 25^\circ\text{C}$, $L = 300\mu\text{H}$, $R_G = 25\Omega$, peak $I_{AS} = 34\text{A}$, (Figure 10).

Typical Performance Curves

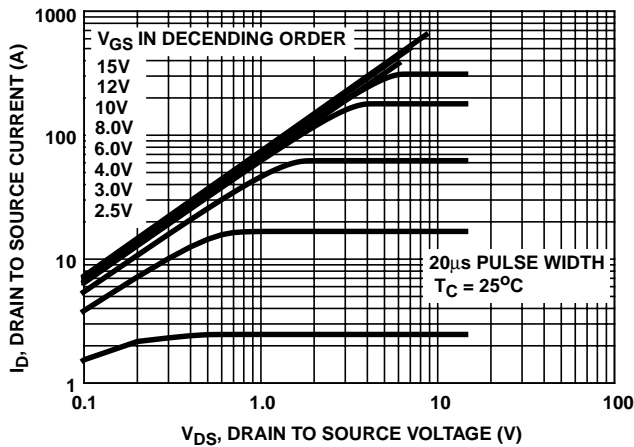

FIGURE 1. OUTPUT CHARACTERISTICS

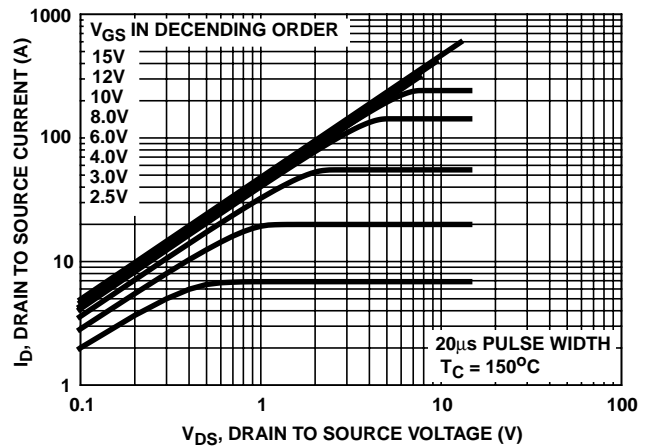

FIGURE 2. OUTPUT CHARACTERISTICS

Typical Performance Curves (Continued)

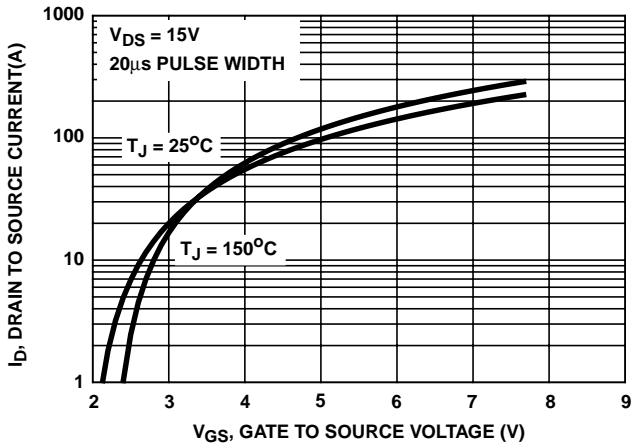

FIGURE 3. TRANSFER CHARACTERISTICS

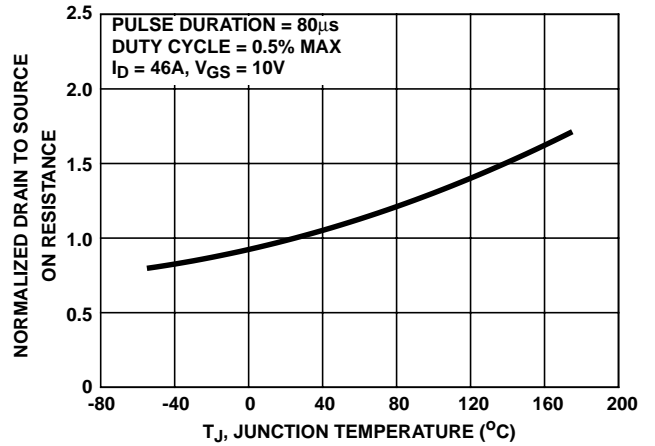

FIGURE 4. NORMALIZED DRAIN TO SOURCE ON RESISTANCE vs JUNCTION TEMPERATURE

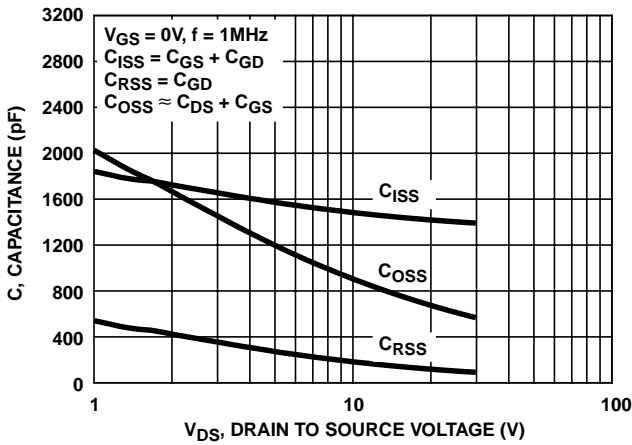

FIGURE 5. CAPACITANCE vs DRAIN TO SOURCE VOLTAGE

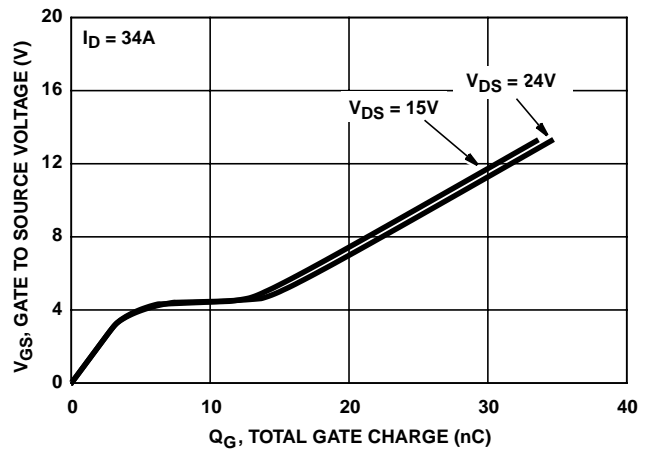

FIGURE 6. GATE CHARGE WAVEFORMS FOR CONSTANT GATE CURRENT

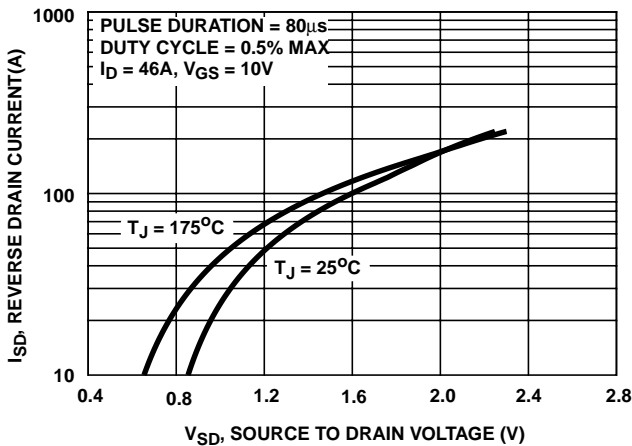

FIGURE 7. SOURCE TO DRAIN DIODE FORWARD VOLTAGE

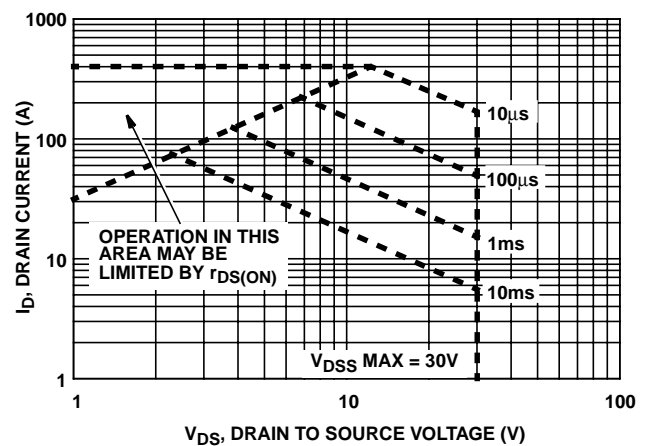

FIGURE 8. FORWARD BIAS SAFE OPERATING AREA

Typical Performance Curves (Continued)

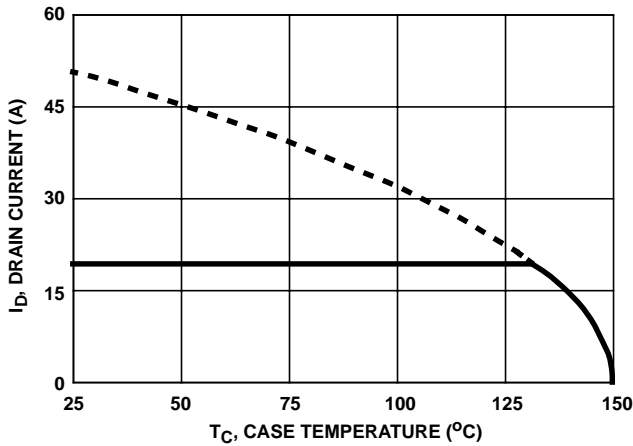

FIGURE 9. MAXIMUM CONTINUOUS DRAIN CURRENT vs CASE TEMPERATURE

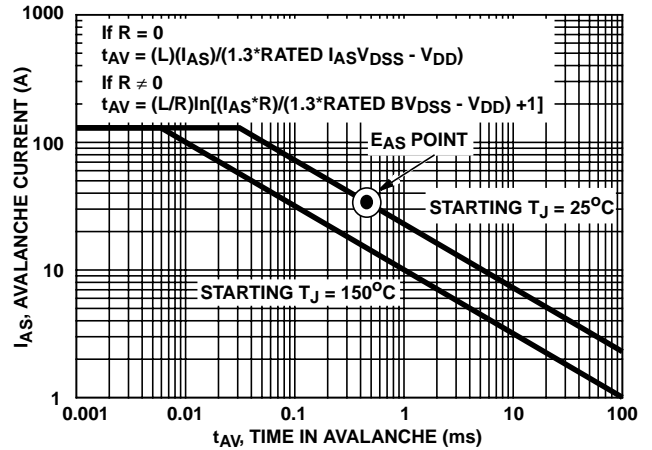

FIGURE 10. UNCLAMPED INDUCTIVE SWITCHING CAPABILITY

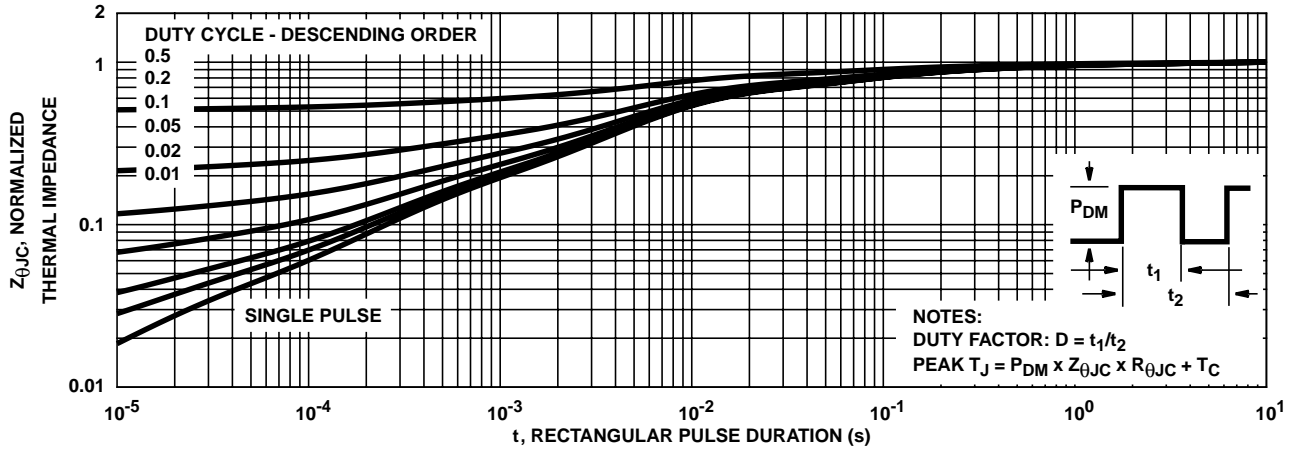

FIGURE 11. NORMALIZED MAXIMUM TRANSIENT THERMAL IMPEDANCE

Test Circuits and Waveforms

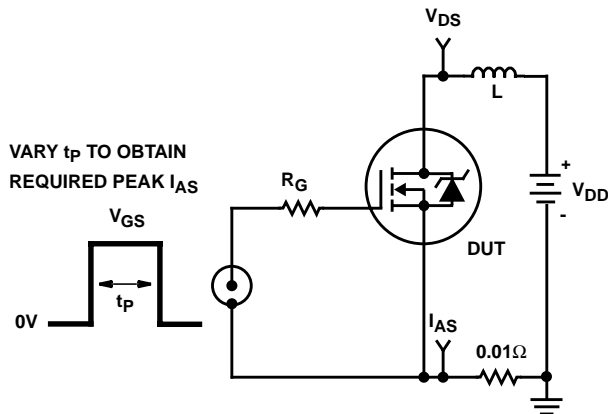

FIGURE 12. UNCLAMPED ENERGY TEST CIRCUIT

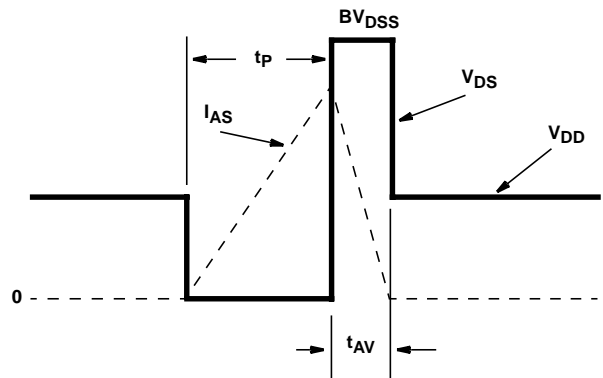

FIGURE 13. UNCLAMPED ENERGY WAVEFORMS

Test Circuits and Waveforms (Continued)

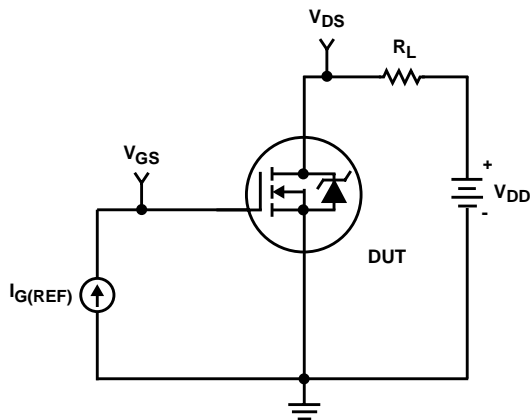

FIGURE 14. GATE CHARGE TEST CIRCUIT

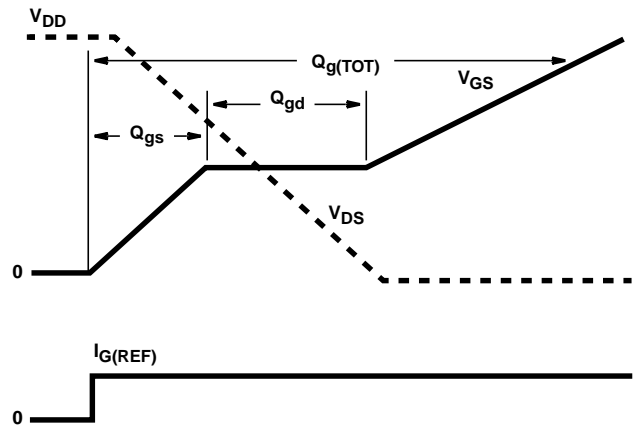

FIGURE 15. GATE CHARGE WAVEFORMS

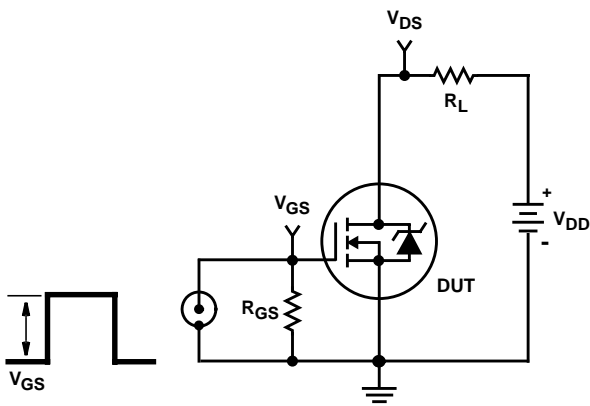

FIGURE 16. SWITCHING TIME TEST CIRCUIT

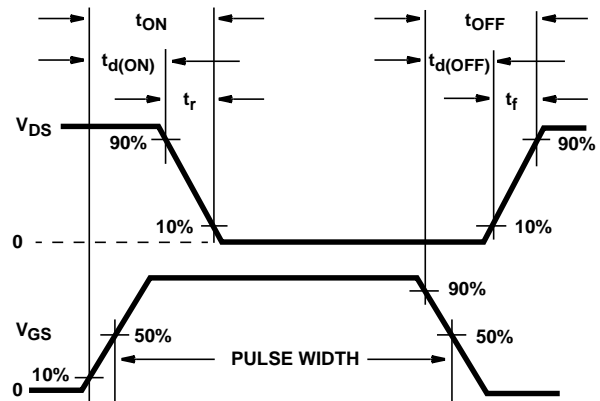

FIGURE 17. RESISTIVE SWITCHING WAVEFORMS

All Intersil semiconductor products are manufactured, assembled and tested under **ISO9000** quality systems certification.

Intersil semiconductor products are sold by description only. Intersil Corporation reserves the right to make changes in circuit design and/or specifications at any time without notice. Accordingly, the reader is cautioned to verify that data sheets are current before placing orders. Information furnished by Intersil is believed to be accurate and reliable. However, no responsibility is assumed by Intersil or its subsidiaries for its use; nor for any infringements of patents or other rights of third parties which may result from its use. No license is granted by implication or otherwise under any patent or patent rights of Intersil or its subsidiaries.

For information regarding Intersil Corporation and its products, see web site <http://www.intersil.com>

Sales Office Headquarters

NORTH AMERICA
 Intersil Corporation
 P. O. Box 883, Mail Stop 53-204
 Melbourne, FL 32902
 TEL: (407) 724-7000
 FAX: (407) 724-7240

EUROPE
 Intersil SA
 Mercure Center
 100, Rue de la Fusee
 1130 Brussels, Belgium
 TEL: (32) 2.724.2111
 FAX: (32) 2.724.22.05

ASIA
 Intersil (Taiwan) Ltd.
 7F-6, No. 101 Fu Hsing North Road
 Taipei, Taiwan
 Republic of China
 TEL: (886) 2 2716 9310
 FAX: (886) 2 2715 3029