

12A, 60V, 0.135 Ohm, N-Channel, Logic Level, Power MOSFETs

These N-Channel logic level ESD protected power MOSFETs are manufactured using the MegaFET process. This process, which uses feature sizes approaching those of LSI integrated circuits, gives optimum utilization of silicon, resulting in outstanding performance. They were designed for use with logic level (5V) driving sources in applications such as programmable controllers, automotive switching, switching regulators, switching converters, motor drivers, relay drivers, and emitter switches for bipolar transistors. This performance is accomplished through a special gate oxide design which provides full rated conductance at gate biases in the 3V to 5V range, thereby facilitating true on-off power control directly from logic circuit supply voltages.

Formerly developmental type TA09861.

Ordering Information

PART NUMBER	PACKAGE	BRAND
RFD12N06RLE	TO-251AA	12N6LE
RFD12N06RLESM	TO-252AA	12N6LE
RFP12N06RLE	TO-220AB	12N06RLE

NOTE: When ordering, use the entire part number. Add the suffix 9A to obtain the TO-252AA variant in tape and reel, i.e., RFD12N06RLESM9A.

Features

- 12A, 60V
- $r_{DS(ON)} = 0.135\Omega$
- Electrostatic Discharge Protected
- UIS Rating Curve (Single Pulse)
- Design Optimized for 5V Gate Drive
- Related Literature
 - TB334 "Guidelines for Soldering Surface Mount Components to PC Boards"

Symbol

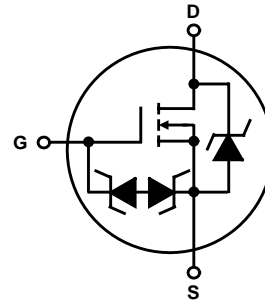

Packaging

JEDEC TO-251AA

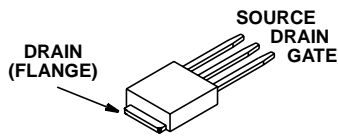

JEDEC TO-252AA

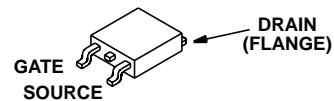

JEDEC TO-220AB

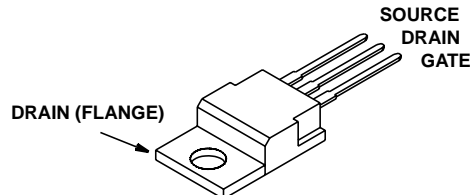

RFD12N06RLE, RFD12N06RLESM, RFP12N06RLE

Absolute Maximum Ratings $T_C = 25^\circ\text{C}$, Unless Otherwise Specified

	RFD12N06RLE, RFD12N06RLESM, RFP12N06RLE	UNITS
Drain to Source Voltage (Note 1)	60	V
Drain to Gate Voltage ($R_{GS} = 20k\Omega$) (Note 1)	60	V
Continuous Drain Current	12	A
Pulsed Drain Current (Note 3)	26	A
Gate to Source Voltage	-5 to 10	V
Power Dissipation	40	W
Linear Derating Factor	0.32	$W/^\circ\text{C}$
Single Pulse Avalanche Energy Rating	Refer to UIS SOA Curve	
Electrostatic Discharge Rating ESD, MIL-STD-883, Category B(2)	2	kV
Operating and Storage Temperature	-55 to 150	$^\circ\text{C}$
Maximum Temperature for Soldering		
Leads at 0.063in (1.6mm) from Case for 10s	300	$^\circ\text{C}$
Package Body for 10s, See Techbrief 334	260	$^\circ\text{C}$

CAUTION: Stresses above those listed in "Absolute Maximum Ratings" may cause permanent damage to the device. This is a stress only rating and operation of the device at these or any other conditions above those indicated in the operational sections of this specification is not implied.

NOTE:

1. $T_J = 25^\circ\text{C}$ to 125°C .

Electrical Specifications $T_C = 25^\circ\text{C}$, Unless Otherwise Specified

PARAMETER	SYMBOL	TEST CONDITIONS	MIN	TYP	MAX	UNITS
Drain to Source Breakdown Voltage	BV_{DSS}	$I_D = 250\mu\text{A}$, $V_{GS} = 0\text{V}$	60	-	-	V
Gate Threshold Voltage	$V_{GS(TH)}$	$V_{GS} = V_{DS}$, $I_D = 250\mu\text{A}$	1	-	2	V
Zero Gate Voltage Drain Current	I_{DSS}	$V_{DS} = \text{Rated } BV_{DSS}$, $V_{GS} = 0\text{V}$	-	-	1	μA
		$V_{DS} = 0.8 \times \text{Rated } BV_{DSS}$, $V_{GS} = 0\text{V}$, $T_C = 150^\circ\text{C}$	-	-	25	μA
Gate to Source Leakage Current	I_{GSS}	$V_{GS} = -5$ to 10V	-	-	± 10	μA
Drain to Source On Resistance (Note 2)	$r_{DS(ON)}$	$I_D = 12\text{A}$, $V_{GS} = 5\text{V}$ (Figures 7, 8)	-	-	0.135	Ω
		$I_D = 12\text{A}$, $V_{GS} = 4\text{V}$	-	-	0.160	Ω
Turn-On Time	$t_{(ON)}$	$V_{DD} = 30\text{V}$, $I_D \approx 6\text{A}$, $R_L = 5\Omega$, $R_{GS} = 6.25\Omega$, $V_{GS} = 5\text{V}$, (Figures 15, 16)	-	-	60	ns
Turn-On Delay Time	$t_{d(ON)}$		-	12	-	ns
Rise Time	t_r		-	20	-	ns
Turn-Off Delay Time	$t_{d(OFF)}$		-	24	-	ns
Fall Time	t_f		-	12	-	ns
Turn-Off Time	$t_{(OFF)}$		-	-	60	ns
Total Gate Charge	$Q_g(\text{TOT})$		$V_{GS} = 0\text{V}$ to 10V	-	-	40
Gate Charge at 5V	$Q_g(5)$	$V_{GS} = 0\text{V}$ to 5V				
Threshold Gate Charge	$Q_g(\text{TH})$	$V_{GS} = 0\text{V}$ to 1V				
Thermal Resistance Junction to Case	$R_{\theta JC}$		-	-	3.125	$^\circ\text{C/W}$
Thermal Resistance Junction to Ambient	$R_{\theta JA}$	TO-251AA and TO-252AA	-	-	100	$^\circ\text{C/W}$
		TO-220AB	-	-	62	$^\circ\text{C/W}$

Source to Drain Diode Specifications

PARAMETER	SYMBOL	TEST CONDITIONS	MIN	TYP	MAX	UNITS
Source to Drain Diode Voltage	V_{SD}	$I_{SD} = 12\text{A}$	-	-	1.2	V
Reverse Recovery Time	t_{rr}	$I_{SD} = 12\text{A}$, $dI_{SD}/dt = 100\text{A}/\mu\text{s}$	-	-	200	ns

NOTES:

2. Pulse test: pulse width $\leq 300\text{ms}$, duty cycle $\leq 2\%$.
3. Repetitive rating: pulse width is limited by maximum junction temperature.

Typical Performance Curves Unless Otherwise Specified

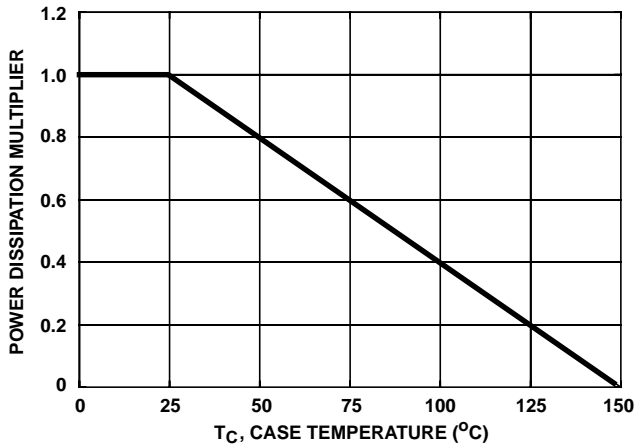

FIGURE 1. NORMALIZED POWER DISSIPATION vs CASE TEMPERATURE

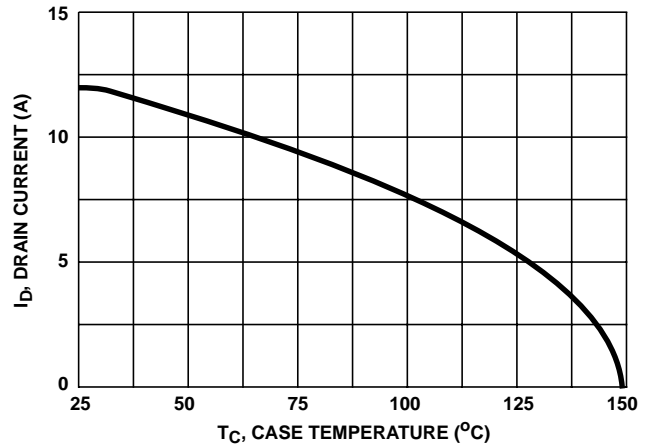

FIGURE 2. MAXIMUM CONTINUOUS DRAIN CURRENT vs CASE TEMPERATURE

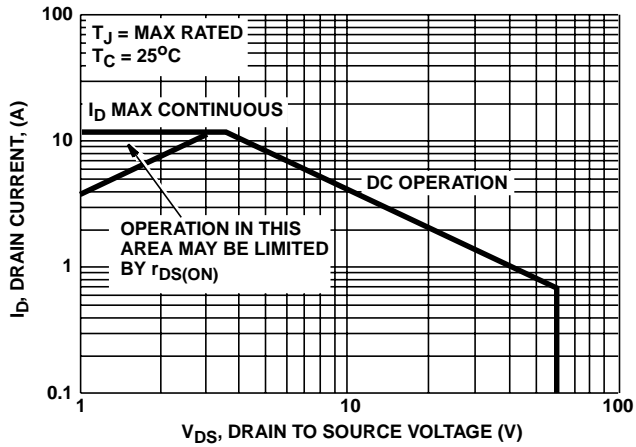
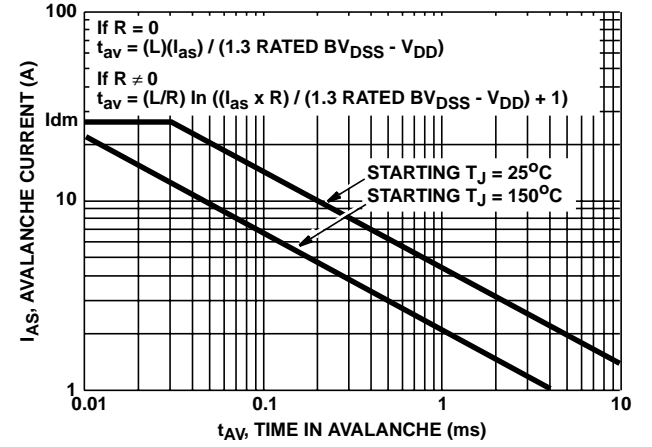

FIGURE 3. FORWARD BIAS SAFE OPERATING AREA



NOTE: Refer to Intersil Application Notes AN9321 and AN9322.

FIGURE 4. UNCLAMPED INDUCTIVE SWITCHING CAPABILITY

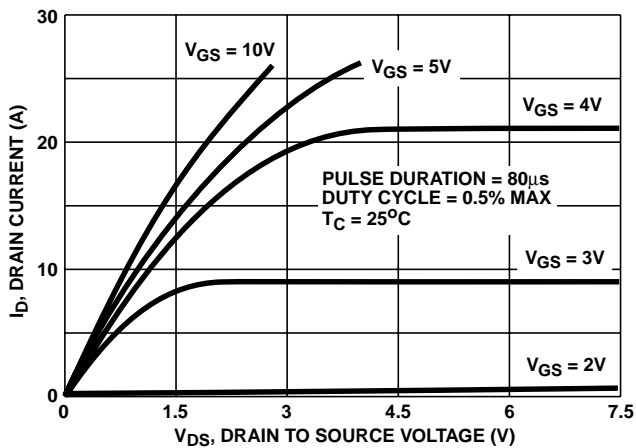

FIGURE 5. SATURATION CHARACTERISTICS

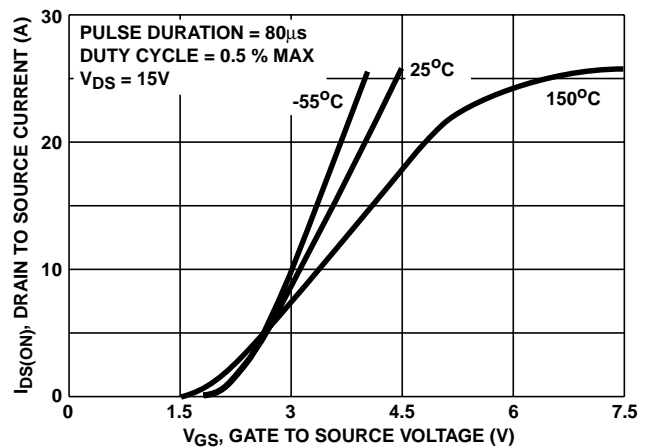

FIGURE 6. TRANSFER CHARACTERISTICS

Typical Performance Curves Unless Otherwise Specified (Continued)

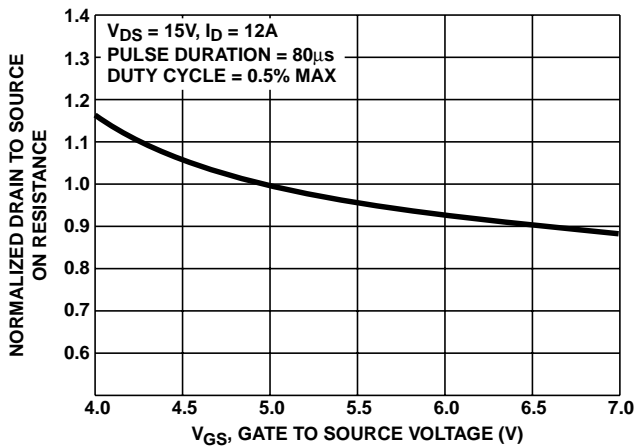

FIGURE 7. NORMALIZED DRAIN TO SOURCE ON RESISTANCE vs GATE TO SOURCE VOLTAGE

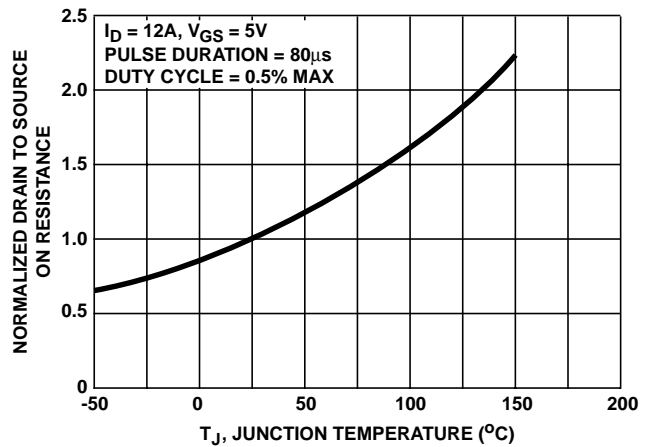

FIGURE 8. NORMALIZED DRAIN TO SOURCE ON RESISTANCE vs JUNCTION TEMPERATURE

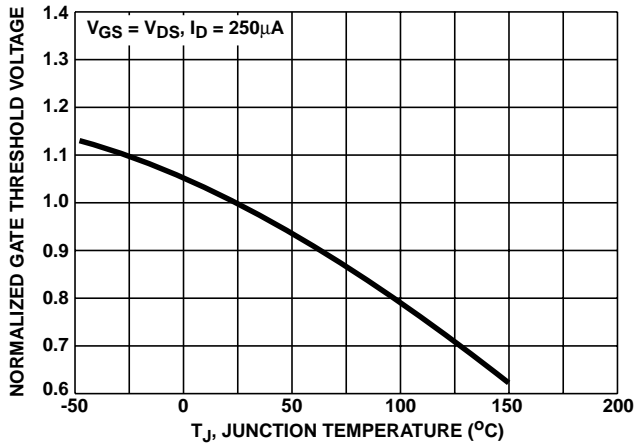

FIGURE 9. NORMALIZED GATE THRESHOLD VOLTAGE vs JUNCTION TEMPERATURE

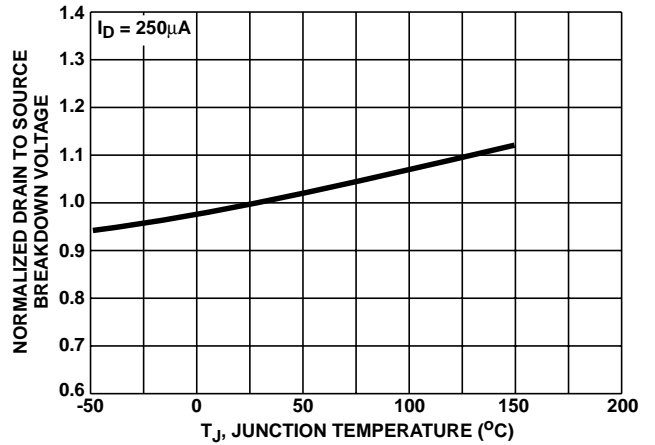

FIGURE 10. NORMALIZED DRAIN TO SOURCE BREAKDOWN VOLTAGE vs JUNCTION TEMPERATURE

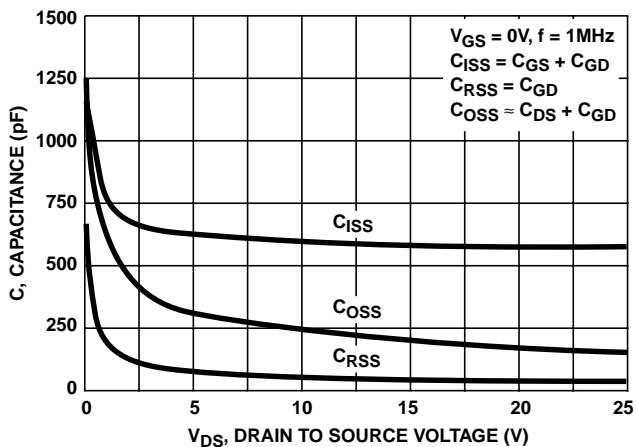
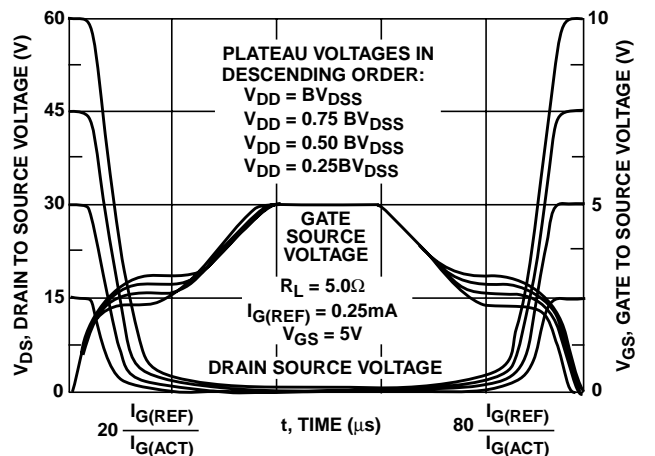

FIGURE 11. CAPACITANCE vs DRAIN TO SOURCE VOLTAGE



NOTE: Refer to Intersil Application Notes AN7254 and AN7260.

FIGURE 12. NORMALIZED SWITCHING WAVEFORMS FOR CONSTANT GATE CURRENT

Test Circuits and Waveforms

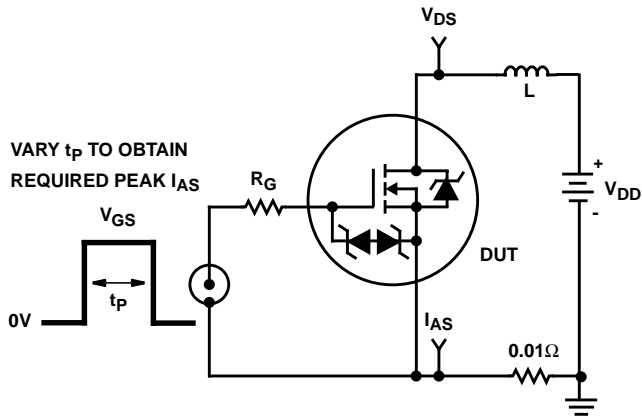

FIGURE 13. UNCLAMPED ENERGY TEST CIRCUIT

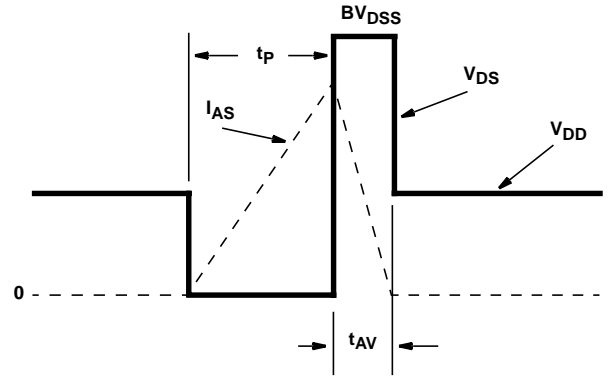

FIGURE 14. UNCLAMPED ENERGY WAVEFORMS

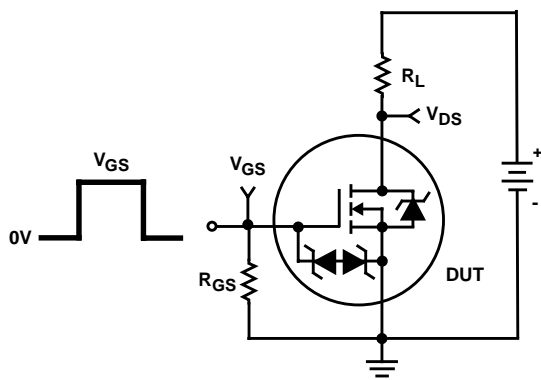

FIGURE 15. SWITCHING TIME TEST CIRCUIT

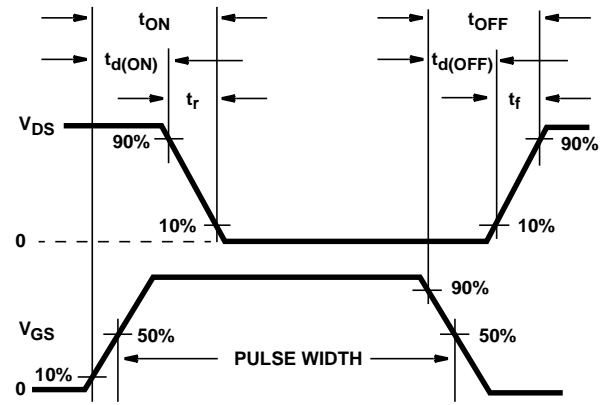

FIGURE 16. RESISTIVE SWITCHING WAVEFORMS

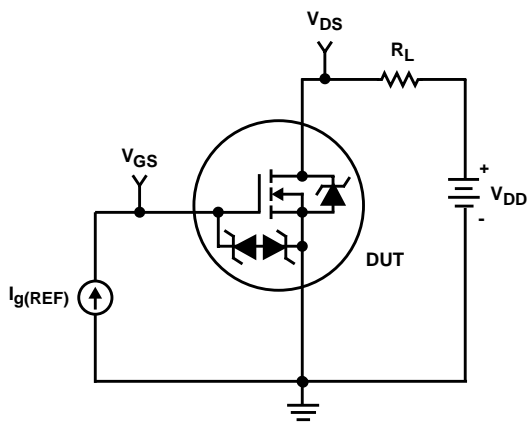

FIGURE 17. GATE CHARGE TEST CIRCUIT

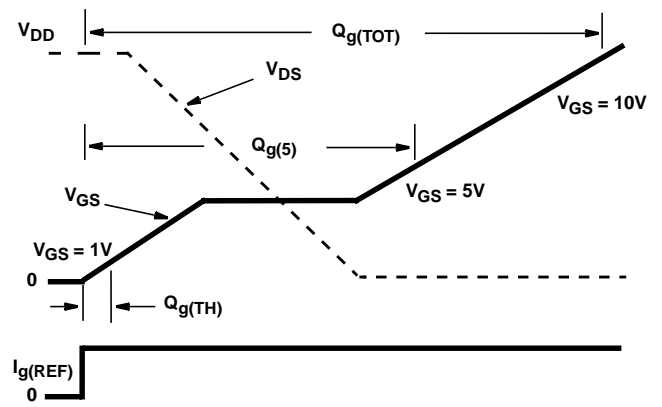

FIGURE 18. GATE CHARGE WAVEFORMS

All Intersil semiconductor products are manufactured, assembled and tested under **ISO9000** quality systems certification.

Intersil semiconductor products are sold by description only. Intersil Corporation reserves the right to make changes in circuit design and/or specifications at any time without notice. Accordingly, the reader is cautioned to verify that data sheets are current before placing orders. Information furnished by Intersil is believed to be accurate and reliable. However, no responsibility is assumed by Intersil or its subsidiaries for its use; nor for any infringements of patents or other rights of third parties which may result from its use. No license is granted by implication or otherwise under any patent or patent rights of Intersil or its subsidiaries.

For information regarding Intersil Corporation and its products, see web site <http://www.intersil.com>

Sales Office Headquarters

NORTH AMERICA

Intersil Corporation
P. O. Box 883, Mail Stop 53-204
Melbourne, FL 32902
TEL: (407) 724-7000
FAX: (407) 724-7240

EUROPE

Intersil SA
Mercure Center
100, Rue de la Fusee
1130 Brussels, Belgium
TEL: (32) 2.724.2111
FAX: (32) 2.724.22.05

ASIA

Intersil (Taiwan) Ltd.
7F-6, No. 101 Fu Hsing North Road
Taipei, Taiwan
Republic of China
TEL: (886) 2 2716 9310
FAX: (886) 2 2715 3029