

FEATURES

- Single Supply Operation
 - Input Voltage Range Extends to Ground
 - Output Swings to Ground while Sinking Current
- *Guaranteed* Offset Voltage 50 μ V Max.
- *Guaranteed* Low Drift 1.3 μ V/ $^{\circ}$ C Max.
- *Guaranteed* Offset Current 0.5nA Max.
- *Guaranteed* High Gain
 - 5mA Load Current 1.5 Million Min.
 - 17mA Load Current 0.8 Million Min.
- *Guaranteed* Low Supply Current 520 μ A Max.
- Supply Current can be Reduced by a Factor of 4
- Low Voltage Noise, 0.1Hz to 10Hz 0.55 μ Vp-p
- Low Current Noise—
 - Better than OP-07 0.07pA/ $\sqrt{\text{Hz}}$ at 10Hz
- High Input Impedance 250M Ω Min.
- *Guaranteed* Minimum Supply Voltage 2.7V Min.

APPLICATIONS

- Low Power Sample and Hold Circuits
- Battery Powered Precision Instrumentation
 - Strain Gauge Signal Conditioners
 - Thermocouple Amplifiers
- 4mA–20mA Current Loop Transmitters
- Active Filters

DESCRIPTION

The LT1006 is the first precision single supply operational amplifier. Its design has been optimized for single supply operation with a full set of specifications at 5V. Specifications at ± 15 V are also provided.

The LT1006 has low offset voltage of 20 μ V, drift of 0.2 μ V/ $^{\circ}$ C, offset current of 120pA, gain of 2.5 million, common-mode rejection of 114dB, and power supply rejection of 126dB.

Although supply current is only 340 μ A, a novel output stage can source or sink in excess of 20mA while retaining high voltage gain. Common-mode input range includes ground to accommodate low ground-referenced inputs from strain gauges or thermocouples, and output can swing to within a few millivolts of ground. If higher slew rate (in excess of 1V/ μ s) or micropower operation (supply current down to 90 μ A) is required, the operating currents can be modified by connecting an external optional resistor to Pin 8.

For similar single supply precision dual and quad op amps, please see the LT1013/LT1014 data sheet. For micropower dual and quad op amps, please see the LT1078/LT1079 data sheet.

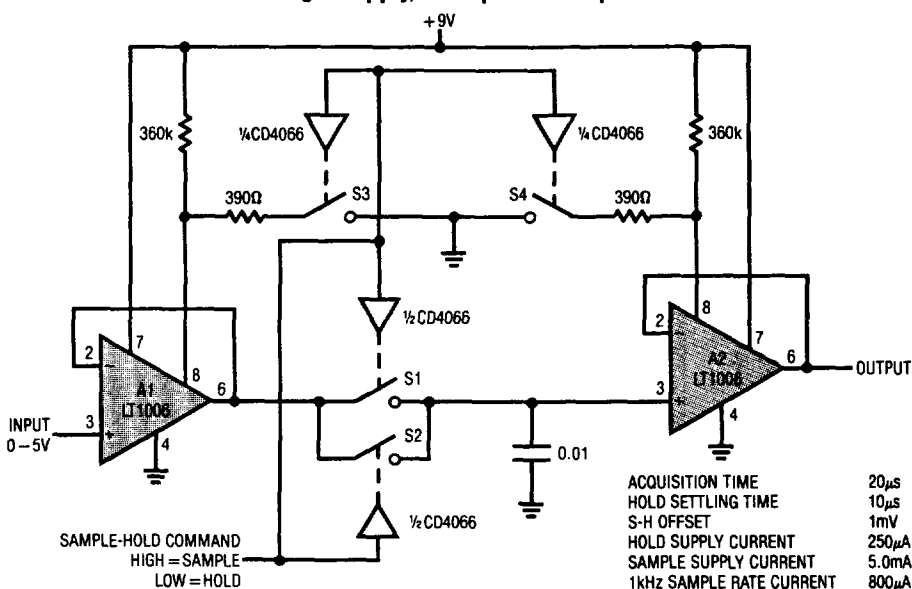
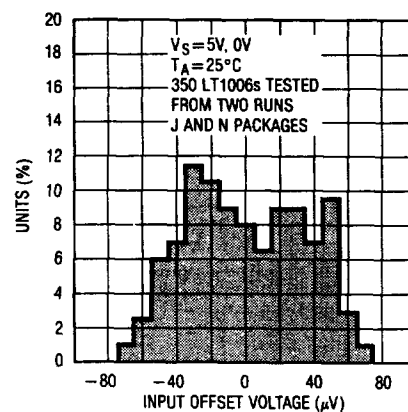
2
LT1006 Single Supply, Micropower Sample and Hold

Distribution of Input Offset Voltage

ABSOLUTE MAXIMUM RATINGS

Supply Voltage $\pm 22V$
 Input Voltage Equal to Positive Supply Voltage
 5V Below Negative Supply Voltage
 Differential Input Voltage..... 30V
 Output Short Circuit Duration Indefinite
 Operating Temperature Range
 LT1006AM, M $-55^{\circ}C$ to $125^{\circ}C$
 LT1006AC, C $0^{\circ}C$ to $70^{\circ}C$
 Storage Temperature Range
 All Devices $-65^{\circ}C$ to $150^{\circ}C$
 Lead Temperature (Soldering, 10 sec) $300^{\circ}C$

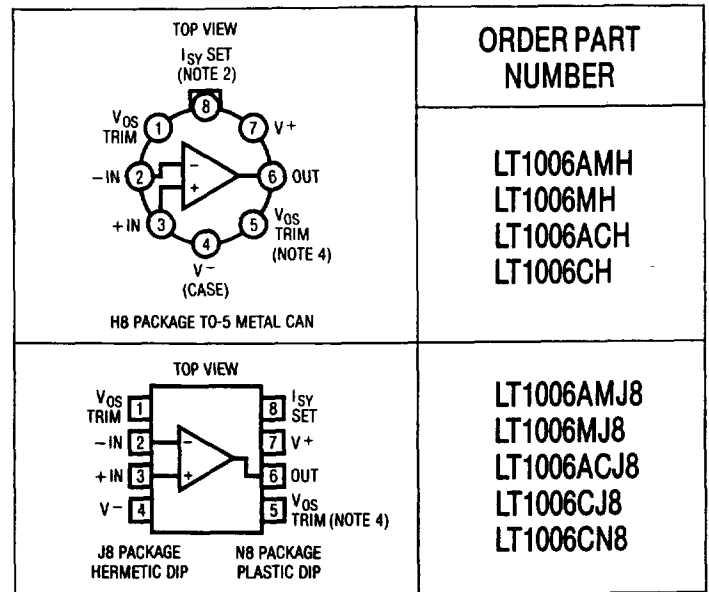
PACKAGE/ORDER INFORMATION



ORDER PART NUMBER
LT1006AMH LT1006MH LT1006ACH LT1006CH
LT1006AMJ8 LT1006MJ8 LT1006ACJ8 LT1006CJ8 LT1006CN8

ELECTRICAL CHARACTERISTICS $V_S = 5V, V_{CM} = 0V, V_{OUT} = 1.4V, T_A = 25^{\circ}C$, unless otherwise noted.

SYMBOL	PARAMETER	CONDITIONS	LT1006AM/AC			LT1006M/C			UNITS
			MIN	TYP	MAX	MIN	TYP	MAX	
V_{OS}	Input Offset Voltage			20	50		30	80	μV
$\frac{\Delta V_{OS}}{\Delta Time}$	Long Term Input Offset Voltage Stability			0.4			0.5		$\mu V/Mo$
I_{OS}	Input Offset Current			0.12	0.5		0.15	0.9	nA
I_B	Input Bias Current			9	15		10	25	nA
e_n	Input Noise Voltage	0.1Hz to 10Hz		0.55			0.55		μV_{p-p}
	Input Noise Voltage Density	$f_o = 10Hz$ (Note 3) $f_o = 1000Hz$ (Note 3)		23 22	32 25		23 22	32 25	nV/\sqrt{Hz} nV/\sqrt{Hz}
i_n	Input Noise Current Density	$f_o = 10Hz$		0.07			0.08		pA/\sqrt{Hz}
	Input Resistance	(Note 1)							$M\Omega$
	Differential Mode		180	400		100	300		$G\Omega$
	Common-Mode			5			4		
	Input Voltage Range		3.5 0	3.8 -0.3		3.5 0	3.8 -0.3		V V
CMRR	Common-Mode Rejection Ratio	$V_{CM} = 0V$ to $3.5V$	100	114		97	112		dB
PSRR	Power Supply Rejection Ratio	$V_S = \pm 2V$ to $\pm 18V, V_O = 0V$	106	126		103	124		dB
A_{VOL}	Large Signal Voltage Gain	$V_O = 0.03V$ to $4V, R_L = 10k$ $V_O = 0.03V$ to $3.5V, R_L = 2k$	1.0 0.5	2.5 2.0		0.7 0.3	2.0 1.8		$V/\mu V$ $V/\mu V$
	Maximum Output Voltage Swing	Output Low, No Load Output Low, 600 Ω to GND Output Low, $I_{SINK} = 1mA$ Output High, No Load Output High, 600 Ω to GND		15 5 220 4.0 3.4	25 10 350		15 5 220 4.0 3.4	25 10 350	mV mV mV V V
SR	Slew Rate		0.25	0.4		0.25	0.4		$V/\mu s$
I_S	Supply Current	$R_{SET} = \infty$ $R_{SET} = 180k$ Pin 8 to Pin 7 (Note 2)		340 90	520		350 90	570	μA μA
	Minimum Supply Voltage		2.7			2.7			V

ELECTRICAL CHARACTERISTICS

$V_S = 5V, 0V, V_{CM} = 0.1V, V_O = 1.4V, -55^{\circ}C \leq T_A \leq 125^{\circ}C$, unless otherwise noted.

SYMBOL	PARAMETER	CONDITIONS	LT1006AM			LT1006M			UNITS
			MIN	TYP	MAX	MIN	TYP	MAX	
V_{OS}	Input Offset Voltage		●	40	180		60	250	μV
$\frac{\Delta V_{OS}}{\Delta Temp}$	Input Offset Voltage Drift		●	0.2	1.3		0.3	1.8	$\mu V/^{\circ}C$
I_{OS}	Input Offset Current		●	0.4	2.0		0.5	4.0	nA
I_B	Input Bias Current		●	13	25		16	40	nA
A_{VOL}	Large Signal Voltage Gain	$V_O = 0.05V$ to $3.5V, R_L = 2k$	●	0.25	0.8		0.15	0.7	$V/\mu V$
CMRR	Common-Mode Rejection Ratio	$V_{CM} = 0.1V$ to $3.2V$	●	90	103		87	102	dB
PSRR	Power Supply Rejection Ratio	$V_S = \pm 2V$ to $\pm 18V, V_O = 0V$	●	100	117		97	116	dB
	Maximum Output Voltage Swing	Output Low, 600Ω to GND Output High, 600Ω to GND	●	6	15		6	18	mV
			●	3.2	3.8		3.1	3.8	V
I_S	Supply Current		●	380	630		400	680	μA

2

ELECTRICAL CHARACTERISTICS

$V_S = 5V, 0V, V_{CM} = 0V, V_O = 1.4V, 0^{\circ}C \leq T_A \leq 70^{\circ}C$, unless otherwise noted.

SYMBOL	PARAMETER	CONDITIONS	LT1006AC			LT1006C			UNITS
			MIN	TYP	MAX	MIN	TYP	MAX	
V_{OS}	Input Offset Voltage	LT1006N8	●	30	110		45	160	μV
			●				50	190	μV
$\frac{\Delta V_{OS}}{\Delta Temp}$	Input Offset Voltage Drift	LT1006N8	●	0.2	1.3		0.3	1.8	$\mu V/^{\circ}C$
			●				0.5	2.5	$\mu V/^{\circ}C$
I_{OS}	Input Offset Current		●	0.25	1.2		0.3	2.5	nA
I_B	Input Bias Current		●	11	20		12	30	nA
A_{VOL}	Large Signal Voltage Gain	$V_O = 0.04V$ to $3.5V, R_L = 2k$	●	0.35	1.3		0.25	1.2	$V/\mu V$
CMRR	Common-Mode Rejection Ratio	$V_{CM} = 0V$ to $3.4V$	●	96	109		92	108	dB
PSRR	Power Supply Rejection Ratio	$V_S = \pm 2V$ to $\pm 18V, V_O = 0V$	●	101	120		97	118	dB
	Maximum Output Voltage Swing	Output Low, 600Ω to GND Output High, 600Ω to GND	●	6	13		6	13	mV
			●	3.3	3.9		3.2	3.9	V
I_S	Supply Current		●	350	570		360	620	μA

The ● denotes the specifications which apply over the full operating temperature range.

Note 1: This parameter is guaranteed by design and is not tested.

Note 2: Regular operation does not require an external resistor. In order to program the supply current for low power or high speed operation, connect an external resistor from Pin 8 to Pin 7 or from Pin 8 to Pin 4, respectively. Supply current specifications (for $R_{SET} = 180k$) do not include current in R_{SET} .

Note 3: This parameter is tested on a sample basis only. All noise parameters are tested with $V_S = \pm 2.5V, V_O = 0V$.

Note 4: Optional offset nulling is accomplished with a potentiometer connected between the trim terminals and the wiper to V^- . A 10k pot (providing a null range of $\pm 6mV$) is recommended for minimum drift of nulled offset voltage with temperature. For increased trim resolution and accuracy, two fixed resistors can be used in conjunction with a smaller potentiometer. For example: two 4.7k resistors tied to pins 1 and 5, with a 500 Ω pot in the middle, will have a null range of $\pm 150\mu V$.

ELECTRICAL CHARACTERISTICS $V_S = \pm 15V, T_A = 25^\circ C$, unless otherwise noted.

SYMBOL	PARAMETER	CONDITIONS	LT1006AM/AC			LT1006M/C			UNITS
			MIN	TYP	MAX	MIN	TYP	MAX	
V_{OS}	Input Offset Voltage			30	100		50	180	μV
I_{OS}	Input Offset Current			0.1	0.5		0.15	0.9	nA
I_B	Input Bias Current			7.5	12.0		8.0	20.0	nA
	Input Voltage Range		13.5 -15.0	13.8 -15.3		13.5 -15.0	13.8 -15.3		V V
CMRR	Common-Mode Rejection Ratio	$V_{CM} = +13.5V, -15V$	100	117		97	116		dB
PSRR	Power Supply Rejection Ratio	$V_S = \pm 2V$ to $\pm 18V, V_O = 0V$	106	126		103	124		dB
A_{VOL}	Large Signal Voltage Gain	$V_O = \pm 10V, R_L = 2k$ $V_O = \pm 10V, R_L = 600\Omega$	1.5 0.8	5.0 1.5		1.2 0.5	4.0 1.0		$V/\mu V$ $V/\mu V$
V_{OUT}	Maximum Output Voltage Swing	$R_L = 2k$	± 13	± 14		± 12.5	± 14		V
SR	Slew Rate	$R_{SET} = \infty$ $R_{SET} = 390\Omega$ Pin 8 to Pin 4	0.25 1.0	0.4 1.2		0.25 1.0	0.4 1.2		$V/\mu s$ $V/\mu s$
I_S	Supply Current		360	540		360	600		μA

ELECTRICAL CHARACTERISTICS $V_S = \pm 15V, -55^\circ C \leq T_A \leq 125^\circ C$, unless otherwise noted.

SYMBOL	PARAMETER	CONDITIONS	LT1006AM			LT1006M			UNITS
			MIN	TYP	MAX	MIN	TYP	MAX	
V_{OS}	Input Offset Voltage			80	320		110	460	μV
$\frac{\Delta V_{OS}}{\Delta Temp}$	Input Offset Voltage Drift			0.5	2.2		0.6	2.8	$\mu V/^\circ C$
I_{OS}	Input Offset Current			0.2	2.0		0.3	3.0	nA
I_B	Input Bias Current			9	18		11	27	nA
A_{VOL}	Large Signal Voltage Gain	$V_O = \pm 10V, R_L = 2k$		0.5	1.5		0.25	1.0	$V/\mu V$
CMRR	Common-Mode Rejection Ratio	$V_{CM} = +13V, -14.9V$		97	114		94	113	dB
PSRR	Power Supply Rejection Ratio	$V_S = \pm 2V$ to $\pm 18V, V_O = 0V$		100	117		97	116	dB
	Maximum Output Voltage Swing	$R_L = 2k$		± 12	± 13.8		± 11.5	± 13.8	V
I_S	Supply Current			400	650		400	750	μA

ELECTRICAL CHARACTERISTICS $V_S = \pm 15V, 0^\circ C \leq T_A \leq 70^\circ C$, unless otherwise noted.

SYMBOL	PARAMETER	CONDITIONS	LT1006AC			LT1006C			UNITS
			MIN	TYP	MAX	MIN	TYP	MAX	
V_{OS}	Input Offset Voltage	LT1006N8		50	200		75 80	300 330	μV μV
$\frac{\Delta V_{OS}}{\Delta Temp}$	Input Offset Voltage Drift	LT1006N8		0.5	2.2		0.6 0.7	2.8 3.5	$\mu V/^\circ C$ $\mu V/^\circ C$
I_{OS}	Input Offset Current			0.15	1.0		0.25	2.0	nA
I_B	Input Bias Current			8.0	15		10	23	nA
A_{VOL}	Large Signal Voltage Gain	$V_O = \pm 10V, R_L = 2k$		1.0	3.0		0.7	2.5	$V/\mu V$
CMRR	Common-Mode Rejection Ratio	$V_{CM} = 13V, -15V$		98	116		94	114	dB
PSRR	Power Supply Rejection Ratio	$V_S = \pm 2V$ to $\pm 18V, V_O = 0V$		101	120		97	118	dB
	Maximum Output Voltage Swing	$R_L = 2k$		± 12.5	± 13.9		± 11.5	± 13.8	V
I_S	Supply Current			370	600		380	660	μA

TYPICAL PERFORMANCE CHARACTERISTICS

Offset Voltage Drift with Temperature of Representative Units

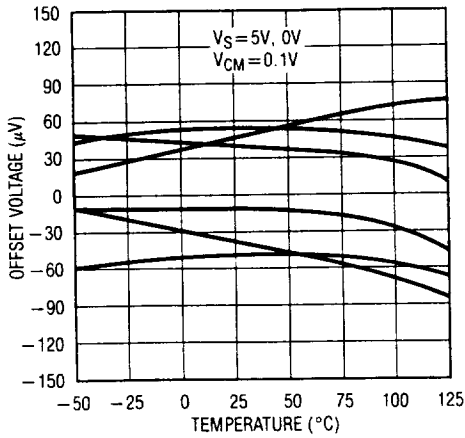

Offset Voltage vs Balanced Source Resistor

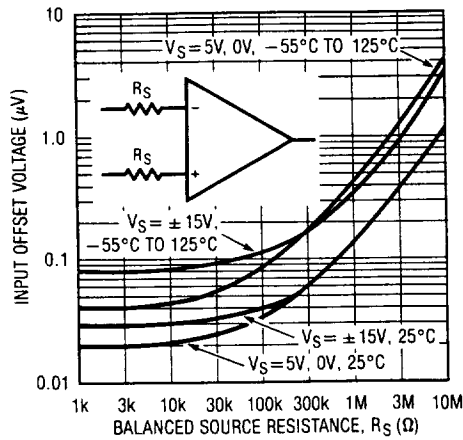

VOS vs Common-Mode Voltage and Temperature

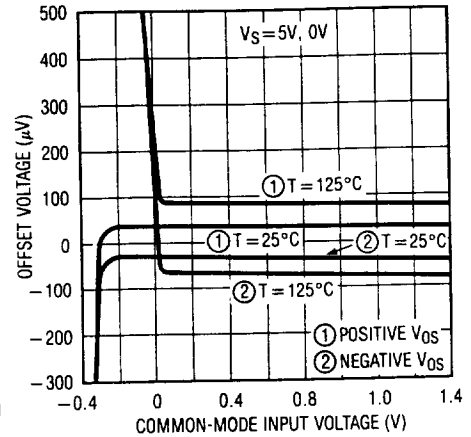

Warm-Up Drift

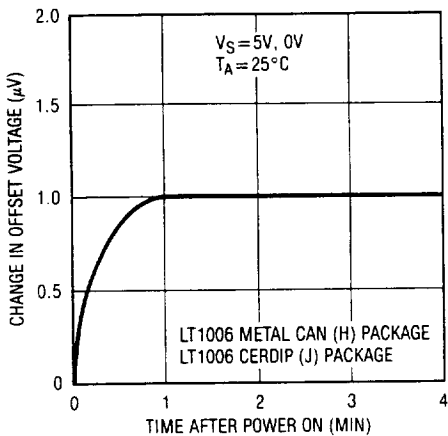

Voltage Gain vs Load Resistance, VS = 5V, 0V

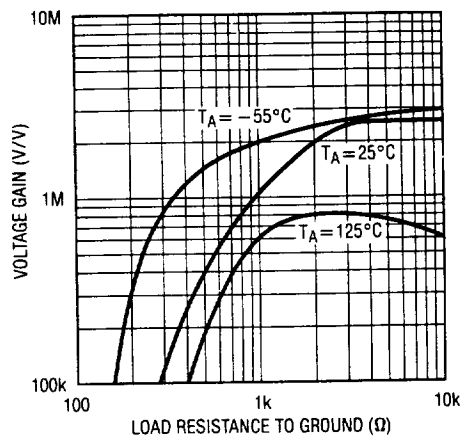

Voltage Gain vs Load Resistance with VS = ± 15V

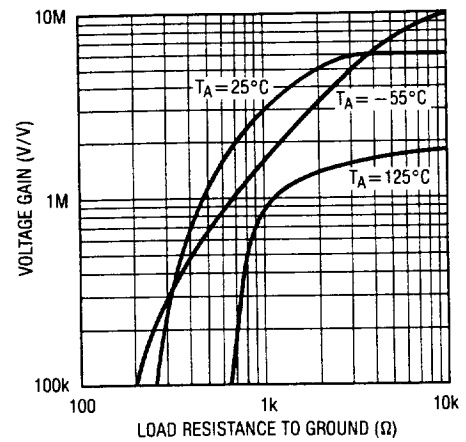

Input Bias Current vs Temperature

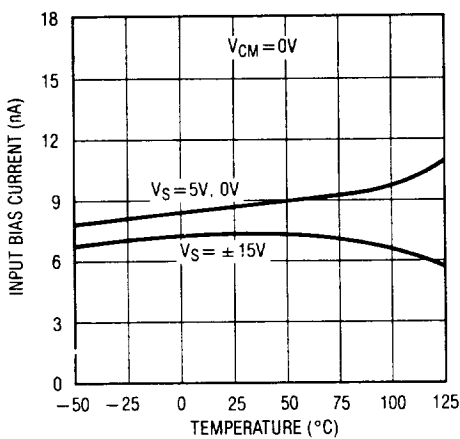

Input Offset Current vs Temperature

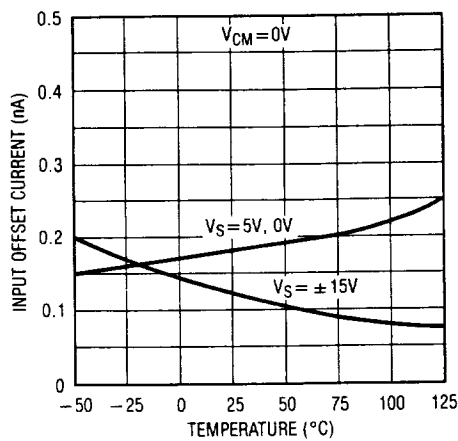

Input Bias Current vs Common-Mode Voltage

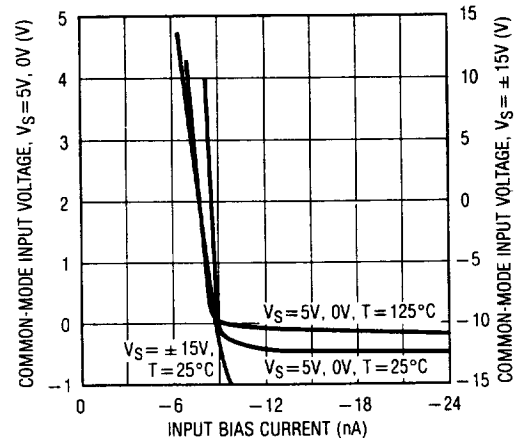

TYPICAL PERFORMANCE CHARACTERISTICS

10Hz Voltage Noise Distribution

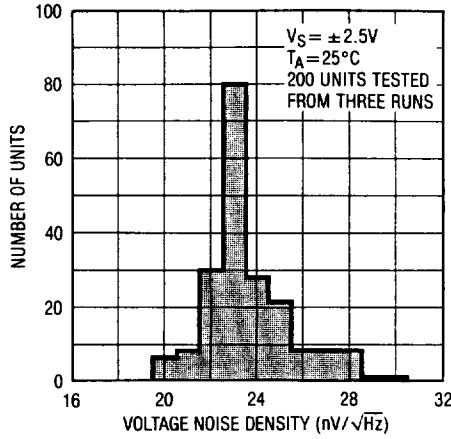

Noise Spectrum

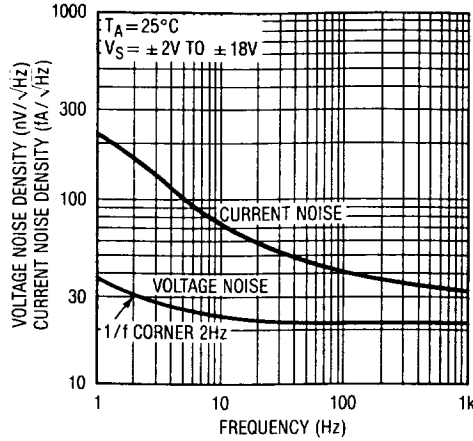

0.1Hz to 10Hz Noise

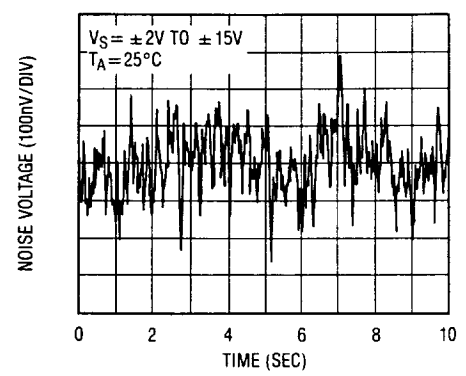

Supply Current vs Temperature

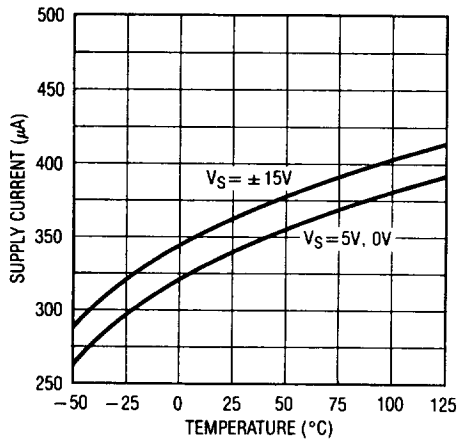

Reducing Power Dissipation

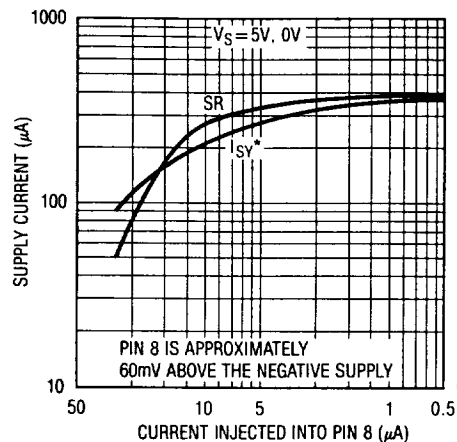

Increasing Slew Rate (R_{SET} to V^-)

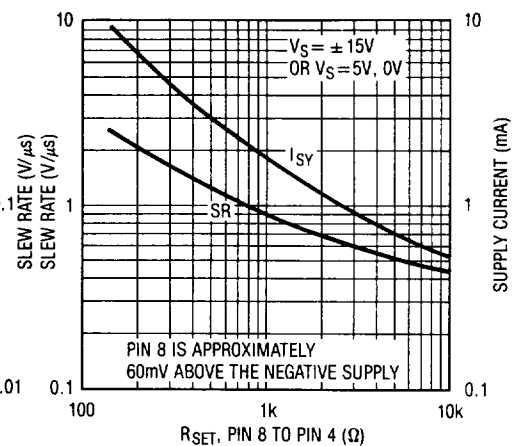

Output Saturation vs Sink Current vs Temperature

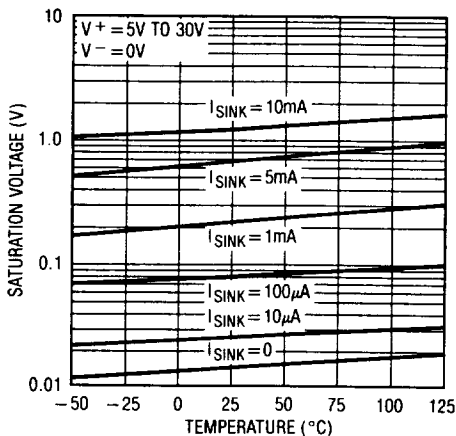

Maximum Output Swing vs Load Resistor

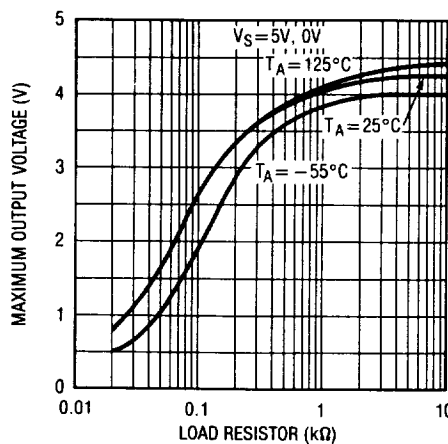

Common-Mode Rejection Ratio vs Frequency

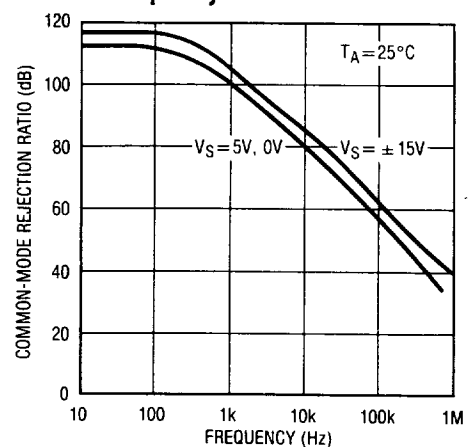

TYPICAL PERFORMANCE CHARACTERISTICS

Voltage Gain vs Frequency

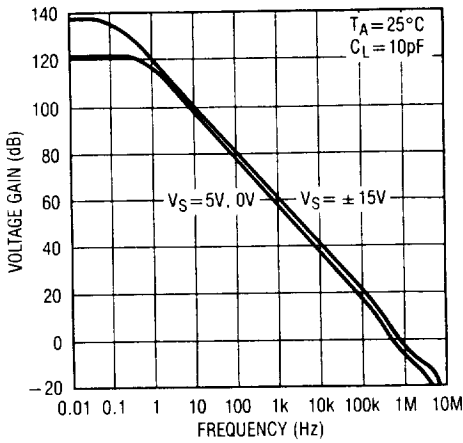

Gain, Phase vs Frequency

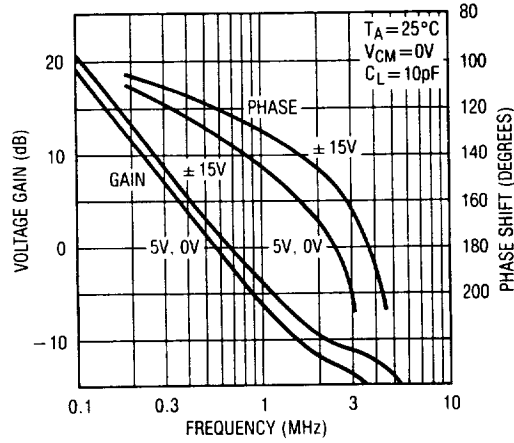

Power Supply Rejection Ratio vs Frequency

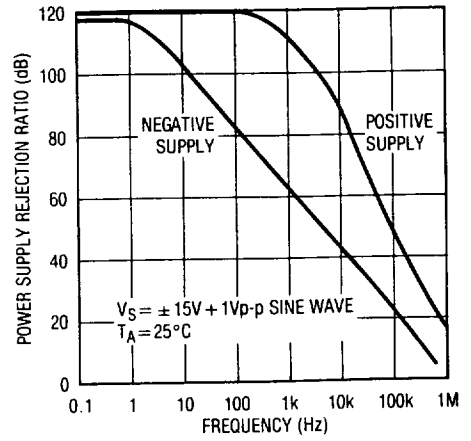

2

Large Transient Response, VS = 5V, 0V

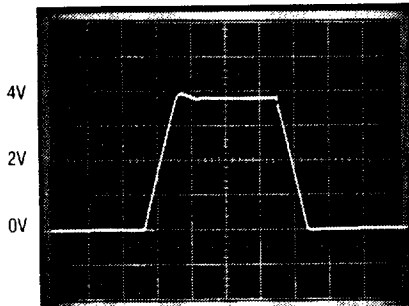

$A_V = 1$
 $R_L = 4.7k$ TO 5V
 INPUT = 0V TO 3.8V

Large Signal Transient Response, VS = 5V, 0V

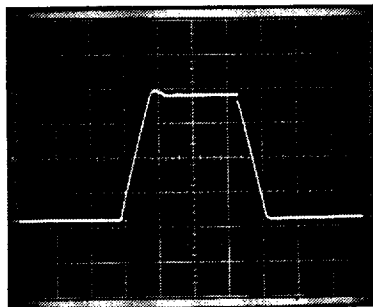

$A_V = 1$
 $R_L = 4.7k$ TO GROUND
 INPUT = 0V TO 3.8V

Large Signal Transient Response, VS = ±15V

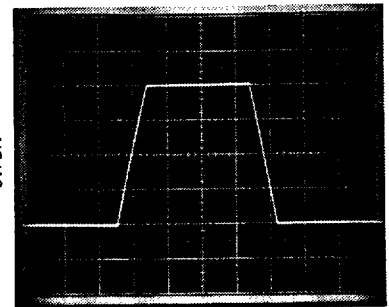

$A_V = 1$

Small Signal Transient Response, VS = 5V, 0V

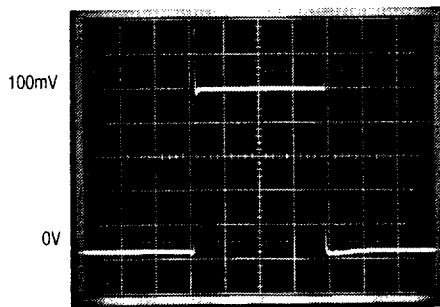

$A_V = 1$
 $C_L = 10pF$
 $R_L = 600\Omega$ TO GND
 INPUT = 0V TO 100mV PULSE

Small Signal Transient Response, VCC = ±2.5V to ±15V

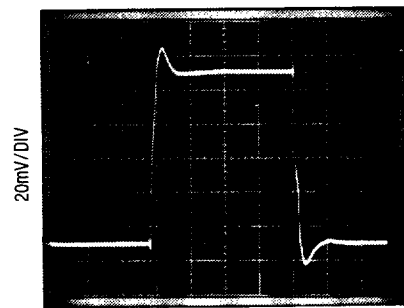

$A_V = 1$
 $C_L = 10pF$

APPLICATIONS INFORMATION

The LT1006 is fully specified for single supply operation, i.e., when the negative supply is 0V. Input common-mode range includes ground; the output swings within a few millivolts of ground. Single supply operation, however, can create special difficulties, both at the input and at the output. The LT1006 has specific circuitry which addresses these problems.

At the input, the driving signal can fall below 0V—inadvertently or on a transient basis. If the input is more than a few hundred millivolts below ground, two distinct problems can occur on previous single supply designs, such as the LM124, LM158, OP-20, OP-21, OP-220, OP-221, OP-420:

- a) When the input is more than a diode drop below ground, unlimited current will flow from the substrate (V^- terminal) to the input. This can destroy the unit. On the LT1006, the 400Ω resistors, in series with the input (see schematic diagram), protect the devices even when the input is 5V below ground.
- b) When the input is more than 400mV below ground (at 25°C), the input stage saturates (transistors Q3 and Q4)

and phase reversal occurs at the output. This can cause lock-up in servo systems. Due to a unique phase reversal protection circuitry (Q21, Q22, Q27, Q28), the LT1006's output does not reverse, as illustrated below, even when the inputs are at -1.5V .

At the output, the aforementioned single supply designs either cannot swing to within 600mV of ground (OP-20) or cannot sink more than a few microamperes while swinging to ground (LM124, LM158). The LT1006's all-NPN output stage maintains its low output resistance and high gain characteristics until the output is saturated.

In dual supply operations, the output stage is crossover distortion-free.

Since the output cannot go exactly to ground, but can only approach ground to within a few millivolts, care should be exercised to ensure that the output is not saturated. For example, a 1mV input signal will cause the amplifier to set up in its linear region in the gain 100 configuration shown below, but is not enough to make the amplifier function properly in the voltage follower mode.

Voltage Follower with Input Exceeding the Negative Common-Mode Range ($V_S = 5\text{V}, 0\text{V}$)

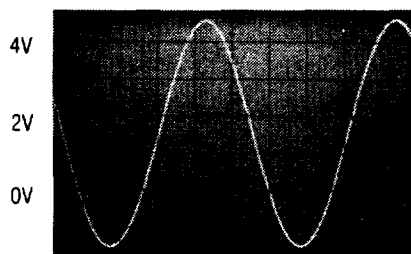

6Vp-p INPUT, $-1.5\text{V TO } 4.5\text{V}$

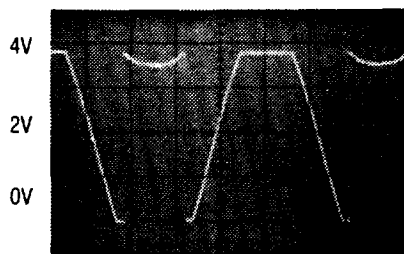

LM324, LM358, OP-20, OP-21
EXHIBIT OUTPUT PHASE
REVERSAL

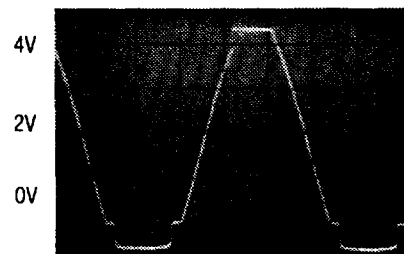

LT1006
NO PHASE REVERSAL

Gain 100 Amplifier

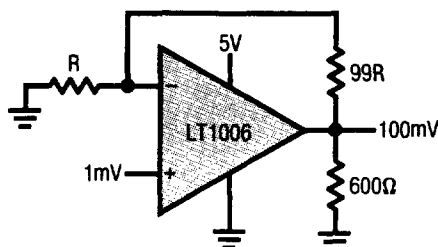

Voltage Follower

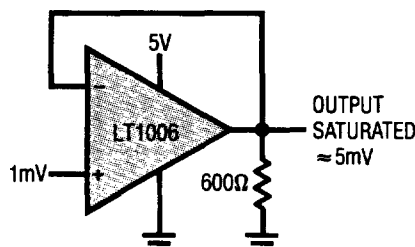

APPLICATIONS INFORMATION

In automated production testing the output is forced to 1.4V by the test loop; offset voltage is measured with a common-mode voltage of zero and the negative supply at zero (Pin 4). Without the test loop, these exact conditions cannot be achieved. The test circuit shown ensures that the output will never saturate even with worst-case offset voltages ($-250\mu\text{V}$ over the -55°C to 125°C range). The effective common-mode input is 0.3V with respect to the negative supply. As indicated by the common-mode rejection specifications the difference is only a few microvolts between the two methods of offset voltage measurement.

Test Circuit for Offset Voltage and Offset Drift with Temperature

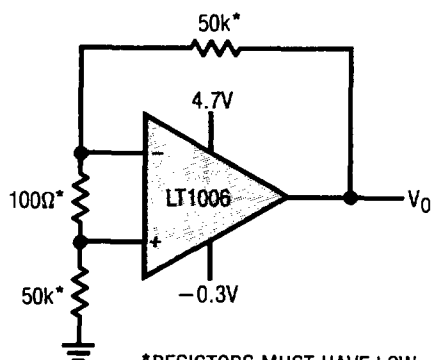

*RESISTORS MUST HAVE LOW THERMOELECTRIC POTENTIAL.

**THIS CIRCUIT IS ALSO USED AS THE BURN-IN CONFIGURATION, WITH SUPPLY VOLTAGES INCREASED TO $\pm 20\text{V}$.

$V_0 = 1000V_0s$

Low Supply Operation

The minimum guaranteed supply voltage for proper operation of the LT1006 is 2.7V. Typical supply current at this voltage is $320\mu\text{A}$, therefore power dissipation is only $860\mu\text{W}$.

Noise Testing

For application information on noise testing and calculations, please see the LT1007 or LT1028 data sheet.

Supply Current Programming

Connecting an optional external resistor to Pin 8 changes the biasing of the LT1006 in order to increase its speed or to decrease its power consumption. If higher slew rate is required, connect the external resistor from Pin 8 to Pin 4 [see performance curves for Increasing Slew Rate (R_{SET} to V^-)]. For lower power consumption, inject a current into Pin 8 (which is approximately 60mV above V^-) as shown on the Reducing Power Dissipation plot. This can be accomplished by connecting R_{SET} to the positive supply, or to save additional power, by obtaining the injected current from a low voltage battery.

2

Comparator Applications

The single supply operation of the LT1006 and its ability to swing close to ground while sinking current lends itself to use as a precision comparator with TTL compatible output.

Comparator Rise Response Time to 10mV, 5mV, 2mV Overdrives

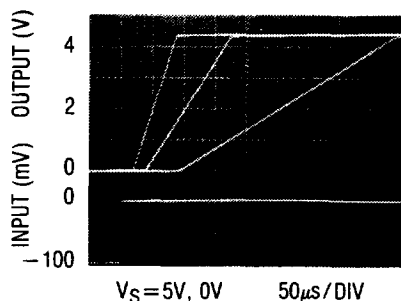

Comparator Fall Response Time to 10mV, 5mV, 2mV Overdrives

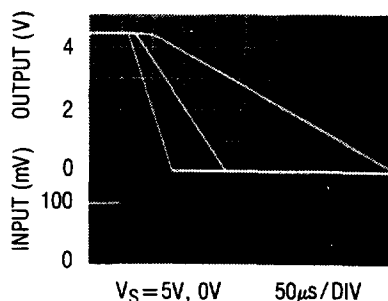

TYPICAL APPLICATIONS

Platinum RTD Signal Conditioner with Curvature Correction

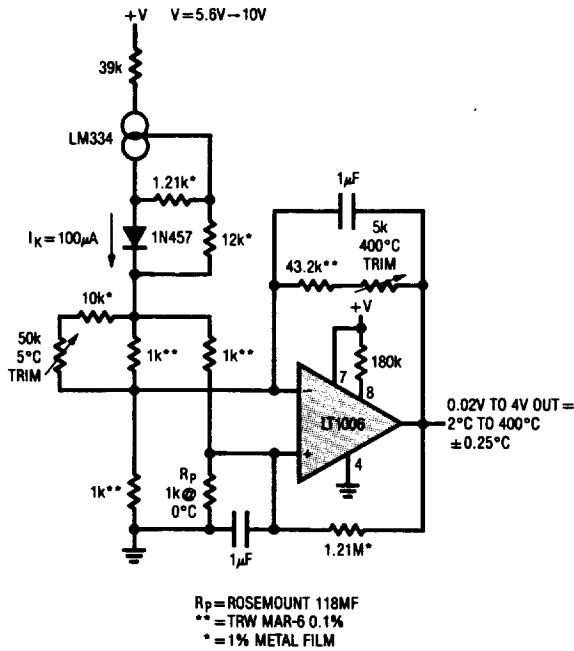

Voltage Controlled Current Source with Ground Referred Input and Output

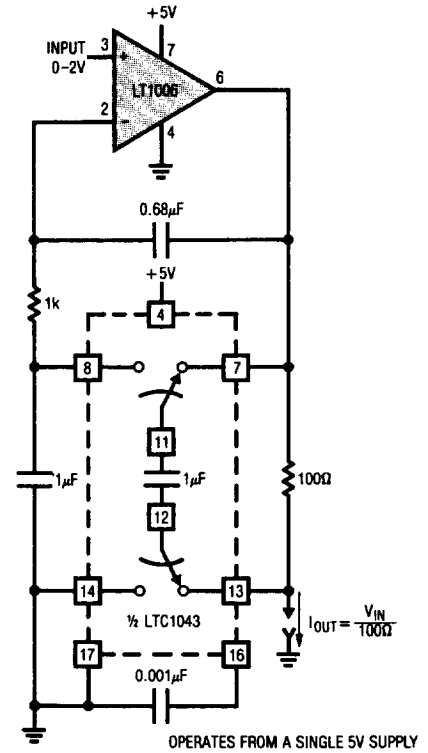

Micropower 1MHz V-F Converter

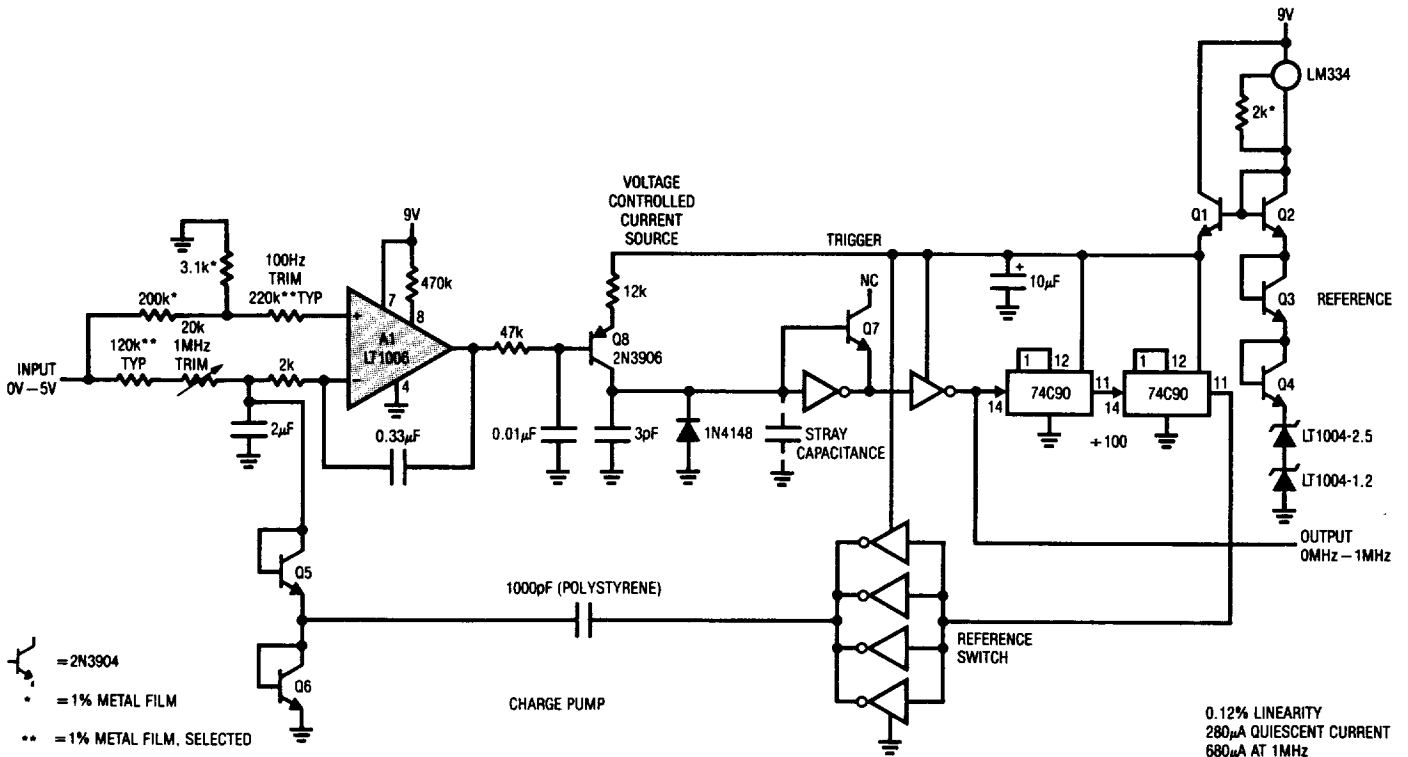

TYPICAL APPLICATIONS

Micropower Thermocouple Signal Conditioner with Cold Junction Compensation

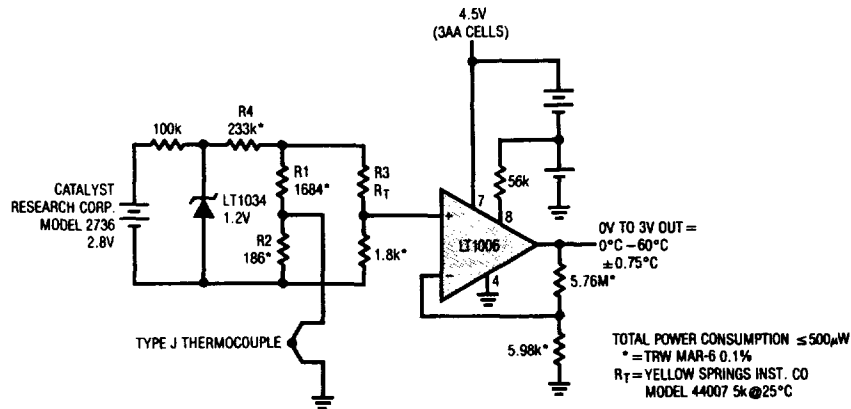

Linear Thermometer

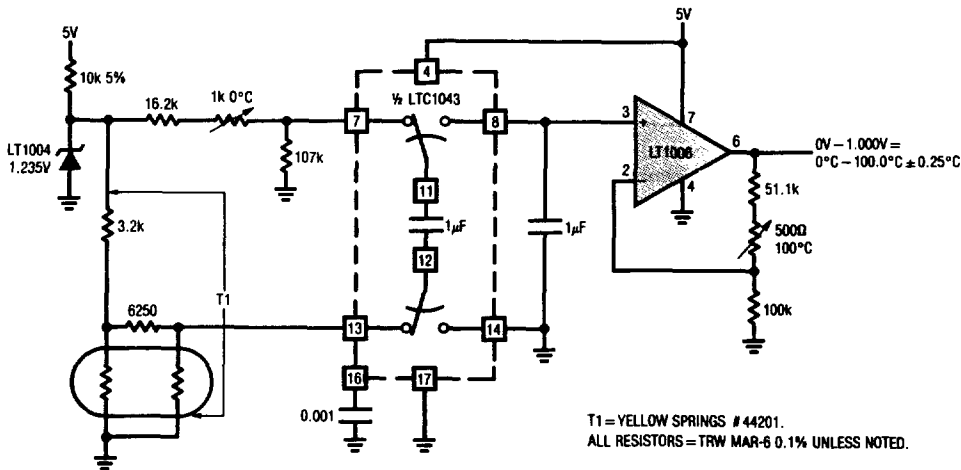

± 5V Precision Instrumentation Amplifier

