

Picoamp Input Current, Microvolt Offset, Low Noise Op Amp

FEATURES

- OP-07 Type Performance
 - at 1/8th of OP-07's Supply Current
 - at 1/20th of OP-07's Bias and Offset Currents
- *Guaranteed* Offset Voltage 25 μ V Max
- *Guaranteed* Bias Current 100pA Max
- *Guaranteed* Drift 0.6 μ V/ $^{\circ}$ C Max
- Low Noise, 0.1Hz to 10Hz 0.5 μ Vp-p
- *Guaranteed* Low Supply Current 500 μ A Max
- *Guaranteed* CMRR 114dB Min
- *Guaranteed* PSRR 114dB Min
- *Guaranteed* Operation @ ± 1.2 V Supplies

APPLICATIONS

- Replaces OP-07 While Saving Power
- Precision Instrumentation
- Charge Integrators
- Wide Dynamic Range Logarithmic Amplifiers
- Light Meters
- Low Frequency Active Filters
- Thermocouple Amplifiers

DESCRIPTION

The LT1012 is an internally compensated universal precision operational amplifier which can be used in practically all precision applications. The LT1012 combines picoampere bias currents (which are maintained over the full -55° C to 125° C temperature range), microvolt offset voltage (and low drift with time and temperature), low voltage and current noise, and low power dissipation. The LT1012 achieves precision operation on two Ni-Cad batteries with 1mW of power dissipation. Extremely high common mode and power supply rejection ratios, practically unmeasurable warm-up drift, and the ability to deliver 5mA load current with a voltage gain of one million round out the LT1012's superb precision specifications.

The all around excellence of the LT1012 eliminates the necessity of the time consuming error analysis procedure of precision system design in many applications; the LT1012 can be stocked as the universal internally compensated precision op amp.

Protected by U.S. patents 4,575,685 and 4,775,884

2

± 250 V Common Mode Range Instrumentation Amplifier ($A_V = 1$)

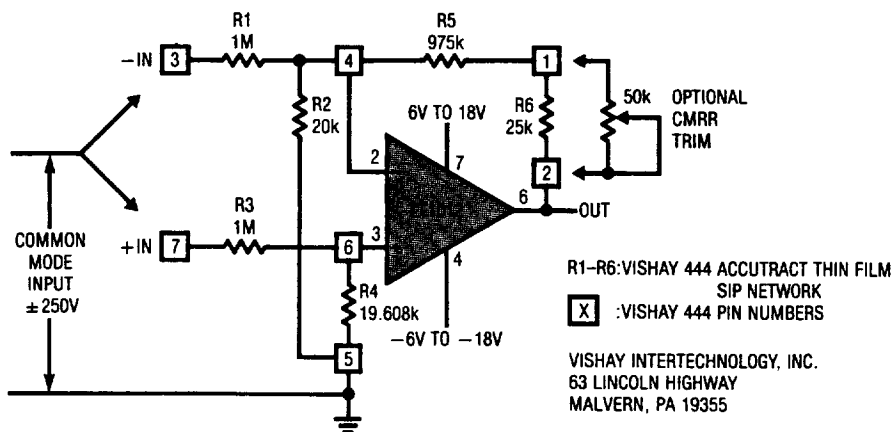

COMMON MODE REJECTION RATIO = 74dB (RESISTOR LIMITED)
 WITH OPTIONAL TRIM = 130dB
 OUTPUT OFFSET (TRIMMABLE TO ZERO) = 500 μ V
 OUTPUT OFFSET DRIFT = 10 μ V/ $^{\circ}$ C
 INPUT RESISTANCE = 1M

Typical Distribution of Input Offset Voltage

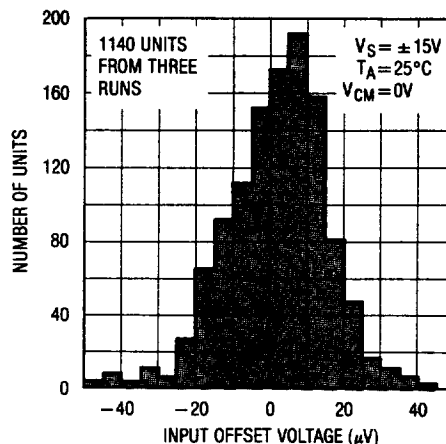

LT1012A/LT1012

ABSOLUTE MAXIMUM RATINGS

Supply Voltage.....	± 20V
Differential Input Current (Note 1).....	± 10mA
Input Voltage.....	± 20V
Output Short Circuit Duration.....	Indefinite
Operating Temperature Range	
LT1012AM, LT1012M.....	-55°C to 125°C
LT1012AC, LT1012C, LT1012D, LT1012S8.....	0°C to 70°C
Storage Temperature Range	
All Devices.....	-65°C to 150°C
Lead Temperature (Soldering, 10 sec.).....	300°C

PACKAGE/ORDER INFORMATION

	ORDER PART NUMBER
	LT1012S8
	PART MARKING
	1012

	ORDER PART NUMBER
	LT1012AMH LT1012MH LT1012ACH LT1012CH LT1012DH
	ORDER PART NUMBER
	LT1012ACN8 LT1012CN8 LT1012DN8

ELECTRICAL CHARACTERISTICS $V_S = \pm 15V, V_{CM} = 0V, T_A = 25^\circ C$, unless otherwise noted.

SYMBOL	PARAMETER	CONDITIONS	LT1012AM/AC			LT1012M			LT1012C			UNITS
			MIN	TYP	MAX	MIN	TYP	MAX	MIN	TYP	MAX	
V_{OS}	Input Offset Voltage	(Note 2)	8	25		8	35		10	50		μV
			20	90		20	90		25	120		μV
	Long Term Input Offset Voltage Stability		0.3			0.3			0.3		$\mu V/month$	
I_{OS}	Input Offset Current	(Note 2)	15	100		15	100		20	150		pA
			25	150		25	150		30	200		pA
I_B	Input Bias Current	(Note 2)	± 25	± 100		± 25	± 100		± 30	± 150		pA
			± 35	± 150		± 35	± 150		± 40	± 200		pA
e_n	Input Noise Voltage	0.1Hz to 10Hz	0.5			0.5			0.5		μV_{p-p}	
e_n	Input Noise Voltage Density	$f_o = 10Hz$ (Note 3)	17	30		17	30		17	30		$nV\sqrt{Hz}$
		$f_o = 1000Hz$ (Note 4)	14	22		14	22		14	22		$nV\sqrt{Hz}$
i_n	Input Noise Current Density	$f_o = 10Hz$	20			20			20		$fA\sqrt{Hz}$	
A_{VOL}	Large Signal Voltage Gain	$V_{OUT} = \pm 12V, R_L \geq 10k\Omega$	300	2000		300	2000		200	2000		V/mV
		$V_{OUT} = \pm 10V, R_L \geq 2k\Omega$	300	1000		200	1000		200	1000		V/mV
CMRR	Common Mode Rejection Ratio	$V_{CM} = \pm 13.5V$	114	132		114	132		110	132		dB
PSRR	Power Supply Rejection Ratio	$V_S = \pm 1.2V$ to $\pm 20V$	114	132		114	132		110	132		dB
			Input Voltage Range	± 13.5	± 14.0		± 13.5	± 14.0		± 13.5	± 14.0	
V_{OUT}	Output Voltage Swing	$R_L = 10k\Omega$	± 13	± 14		± 13	± 14		± 13	± 14		V
			Slew Rate	0.1	0.2		0.1	0.2		0.1	0.2	
I_S	Supply Current	(Note 2)	370	500		380	—		380	—		μA
			380	600		380	600		380	600		μA

ELECTRICAL CHARACTERISTICS $V_S = \pm 15V, V_{CM} = 0V, T_A = 25^\circ C$, unless otherwise noted.

SYMBOL	PARAMETER	CONDITIONS	LT1012D			LT1012S8			UNITS
			MIN	TYP	MAX	MIN	TYP	MAX	
V_{OS}	Input Offset Voltage	(Note 2)		12	60		15	120	μV
				25	—		25	180	μV
	Long Term Input Offset Voltage Stability			0.3			0.4	$\mu V/month$	
I_{OS}	Input Offset Current	(Note 2)		20	150		50	280	pA
				30	—		60	380	pA
I_B	Input Bias Current	(Note 2)		± 30	± 150		± 80	± 300	pA
				± 40	—		± 120	± 400	pA
e_n	Input Noise Voltage	0.1Hz to 10Hz		0.5			0.5	$\mu Vp-p$	
e_n	Input Noise Voltage Density	$f_o = 10Hz$ (Note 4)		17	30		17	30	$nV\sqrt{Hz}$
		$f_o = 1000Hz$ (Note 4)		14	22		14	22	$nV\sqrt{Hz}$
i_n	Input Noise Current Density	$f_o = 10Hz$		20			20	$fA\sqrt{Hz}$	
A_{VOL}	Large Signal Voltage Gain	$V_{OUT} = \pm 12V, R_L \geq 10k\Omega$	200	2000		200	2000	V/mV	
		$V_{OUT} = \pm 10V, R_L \geq 2k\Omega$	200	1000		120	1000	V/mV	
CMRR	Common Mode Rejection Ratio	$V_{CM} = \pm 13.5V$	110	132		110	132	dB	
PSRR	Power Supply Rejection Ratio	$V_S = \pm 1.2V$ to $\pm 20V$	110	132		110	132	dB	
	Input Voltage Range		± 13.5	± 14.0		± 13.5	± 14.0	V	
V_{OUT}	Output Voltage Swing	$R_L = 10k\Omega$		± 13	± 14		± 13	± 14	V
				0.1	0.2		0.1	0.2	$V/\mu sec$
I_S	Supply Current	(Note 2)		380	600		380	600	μA

2

ELECTRICAL CHARACTERISTICS $V_S = \pm 15V, V_{CM} = 0V, -55^\circ C \leq T_A \leq 125^\circ C$, unless otherwise noted.

SYMBOL	PARAMETER	CONDITIONS	LT1012AM			LT1012M			UNITS
			MIN	TYP	MAX	MIN	TYP	MAX	
V_{OS}	Input Offset Voltage	(Note 2)	●	30	60		30	180	μV
			●	40	180		40	250	μV
	Average Temperature Coefficient of Input Offset Voltage		●	0.2	0.6		0.2	1.5	$\mu V/^\circ C$
I_{OS}	Input Offset Current	(Note 2)	●	30	250		30	250	pA
			●	70	350		70	350	pA
	Average Temperature Coefficient of Input Offset Current		●	0.3	2.5		0.3	2.5	$pA/^\circ C$
I_B	Input Bias Current	(Note 2)	●	± 80	± 600		± 80	± 600	pA
			●	± 150	± 800		± 150	± 800	pA
	Average Temperature Coefficient of Input Bias Current		●	0.6	6.0		0.6	6.0	$pA/^\circ C$
A_{VOL}	Large Signal Voltage Gain	$V_{OUT} = \pm 12V, R_L \geq 10k\Omega$	●	200	1000		150	1000	V/mV
		$V_{OUT} = \pm 10V, R_L \geq 2k\Omega$	●	200	600		100	600	V/mV
CMRR	Common Mode Rejection Ratio	$V_{CM} = \pm 13.5V$	●	110	128		108	128	dB
PSRR	Power Supply Rejection Ratio	$V_S = \pm 1.5V$ to $\pm 20V$	●	110	126		108	126	dB
	Input Voltage Range		●	± 13.5			± 13.5		V
V_{OUT}	Output Voltage Swing	$R_L = 10k\Omega$	●	± 13	± 14		± 13	± 14	V
			●						
I_S	Supply Current		●	400	650		400	800	μA

The ● denotes the specifications which apply over the full operating temperature range.

Note 1: Differential input voltages greater than 1V will cause excessive current to flow through the input protection diodes unless limiting resistance is used.

Note 2: These specifications apply for $V_{MIN} \leq V_S \leq \pm 20V$ and $-13.5V \leq V_{CM} \leq 13.5V$ (for $V_S = \pm 15V$). $V_{MIN} = \pm 1.2V$ at $25^\circ C$, $\pm 1.3V$ from $0^\circ C$ to $70^\circ C$, $\pm 1.5V$ from $-55^\circ C$ to $125^\circ C$.

Note 3: 10Hz noise voltage density is sample tested on every lot. Devices 100% tested at 10Hz are available on request.

Note 4: This parameter is tested on a sample basis only.

LT1012A/LT1012

ELECTRICAL CHARACTERISTICS $V_S = \pm 15V, V_{CM} = 0V, 0^\circ C \leq T_A \leq 70^\circ C$, unless otherwise noted.

SYMBOL	PARAMETER	CONDITIONS	LT1012AC			LT1012C			UNITS
			MIN	TYP	MAX	MIN	TYP	MAX	
V_{OS}	Input Offset Voltage	(Note 2)	●	20	60	20	100	μV	
			●	30	160	30	200	μV	
	Average Temperature Coefficient of Input Offset Voltage		●	0.2	0.6	0.2	1.0	$\mu V/^\circ C$	
I_{OS}	Input Offset Current	(Note 2)	●	25	230	35	230	pA	
			●	40	300	45	300	pA	
	Average Temperature Coefficient of Input Offset Current		●	0.3	2.5	0.3	2.5	pA/ $^\circ C$	
I_B	Input Bias Current	(Note 2)	●	± 35	± 230	± 35	± 230	pA	
			●	± 50	± 300	± 50	± 300	pA	
	Average Temperature Coefficient of Input Bias Current		●	0.3	2.5	0.3	2.5	pA/ $^\circ C$	
A_{VOL}	Large Signal Voltage Gain	$V_{OUT} = \pm 12V, R_L \geq 10k\Omega$	●	200	1500	150	1500	V/mV	
		$V_{OUT} = \pm 10V, R_L \geq 2k\Omega$	●	200	1000	150	800	V/mV	
CMRR	Common Mode Rejection Ratio	$V_{CM} = \pm 13.5V$	●	110	130	108	130	dB	
PSRR	Power Supply Rejection Ratio	$V_S = \pm 1.3V$ to $\pm 20V$	●	110	128	108	128	dB	
			●	± 13.5		± 13.5		V	
V_{OUT}	Output Voltage Swing	$R_L = 10k\Omega$	●	± 13	± 14	± 13	± 14	V	
I_S	Supply Current		●	400	600	400	800	μA	

ELECTRICAL CHARACTERISTICS $V_S = \pm 15V, V_{CM} = 0V, 0^\circ C \leq T_A \leq 70^\circ C$, unless otherwise noted.

SYMBOL	PARAMETER	CONDITIONS	LT1012D			LT1012S8			UNITS
			MIN	TYP	MAX	MIN	TYP	MAX	
V_{OS}	Input Offset Voltage	(Note 2)	●	25	140	30	200	μV	
			●	40	—	45	270	μV	
	Average Temperature Coefficient of Input Offset Voltage		●	0.3	1.7	0.3	1.8	$\mu V/^\circ C$	
I_{OS}	Input Offset Current	(Note 2)	●	35	380	60	380	pA	
			●	45	—	80	500	pA	
	Average Temperature Coefficient of Input Offset Current		●	0.35	4.0	0.4	4.0	pA/ $^\circ C$	
I_B	Input Bias Current	(Note 2)	●	± 50	± 420	± 100	± 420	pA	
			●	± 65	—	± 150	± 550	pA	
	Average Temperature Coefficient of Input Bias Current		●	0.4	5.0	0.5	5.0	pA/ $^\circ C$	
A_{VOL}	Large Signal Voltage Gain	$V_{OUT} = \pm 12V, R_L \geq 10k\Omega$	●	150	1500	150	1500	V/mV	
		$V_{OUT} = \pm 10V, R_L \geq 2k\Omega$	●	150	800	100	800	V/mV	
CMRR	Common Mode Rejection Ratio	$V_{CM} = \pm 13.5V$	●	108	130	108	130	dB	
PSRR	Power Supply Rejection Ratio	$V_S = \pm 1.3V$ to $\pm 20V$	●	108	128	108	128	dB	
			●	± 13.5		± 13.5		V	
V_{OUT}	Output Voltage Swing	$R_L = 10k\Omega$	●	± 13	± 14	± 13	± 14	V	
I_S	Supply Current		●	400	800	400	800	μA	

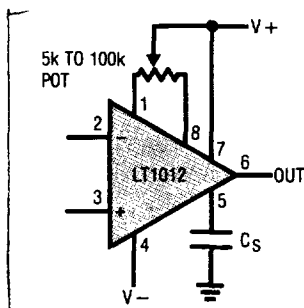

Optional Offset Nulling and Over-Compensation Circuits

Input offset voltage can be adjusted over a $\pm 800\mu V$ range with a 5k to 100k potentiometer.

The LT1012 is internally compensated for unity gain stability. The over-compensation capacitor, C_S , can be used to improve capacitive load handling capability, to narrow noise bandwidth, or to stabilize circuits with gain in the feedback loop.

TYPICAL PERFORMANCE CHARACTERISTICS

Offset Voltage vs Source Resistance (Balanced or Unbalanced)

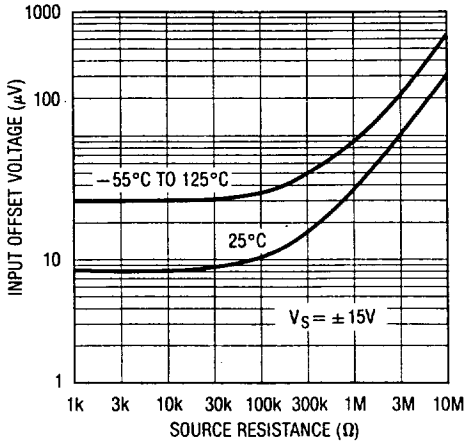

Typical Distribution of Input Bias Current

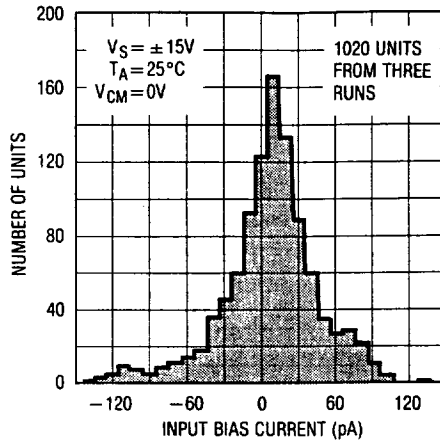

Typical Distribution of Input Offset Current

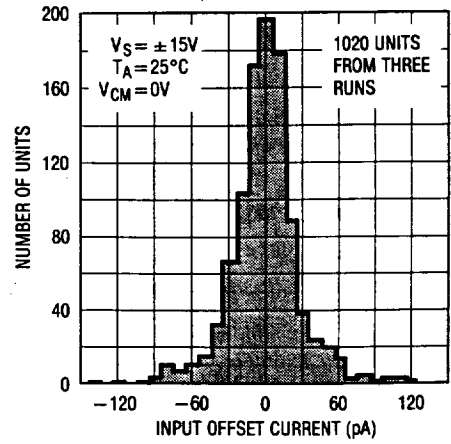

2

Input Bias Current vs Temperature

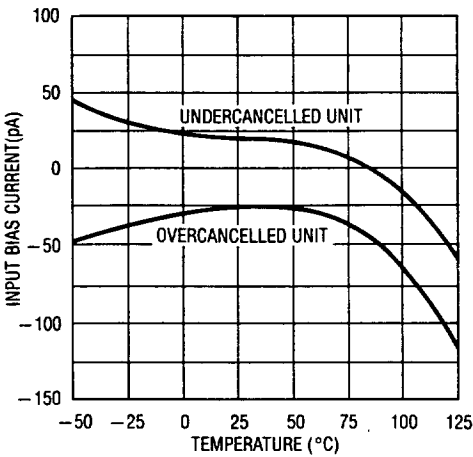

Input Bias Current Over Common Mode Range

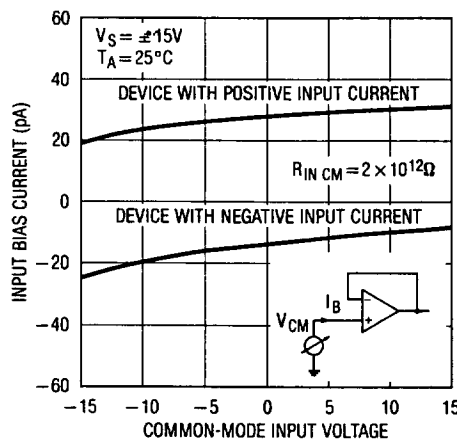

Offset Voltage Drift vs Source Resistance (Balanced or Unbalanced)

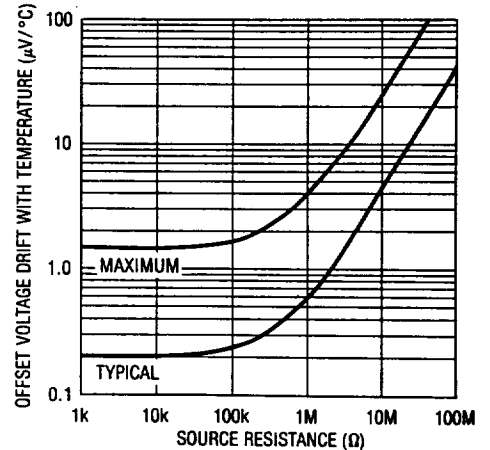

Warm-Up Drift

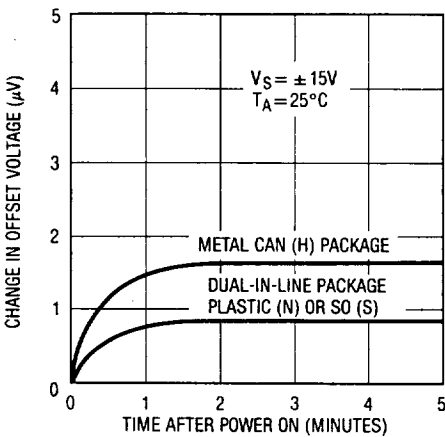

Long Term Stability of Four Representative Units

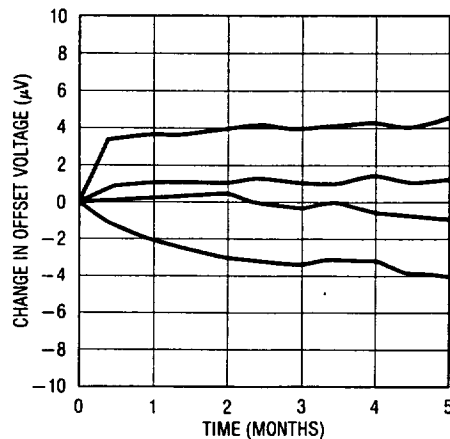

Offset Voltage Drift with Temperature of Four Representative Units

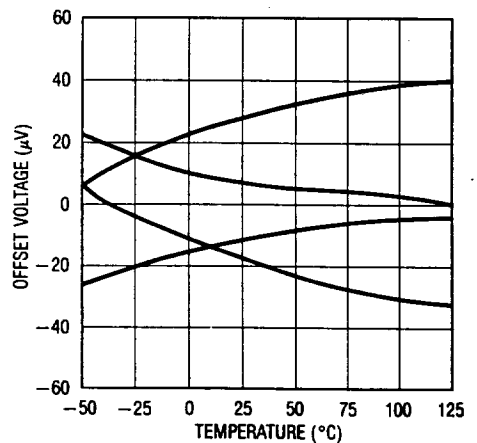

TYPICAL PERFORMANCE CHARACTERISTICS

0.1Hz to 10Hz Noise

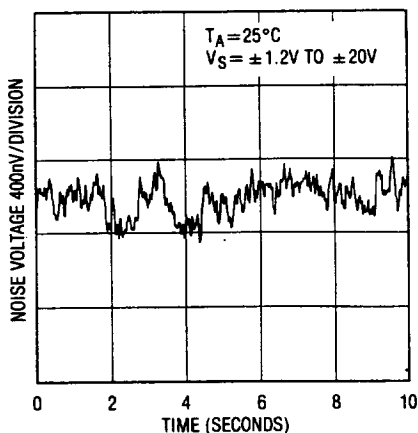

Noise Spectrum

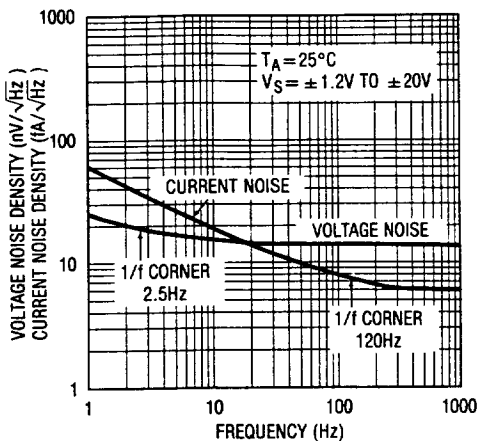

Total Noise vs Source Resistance

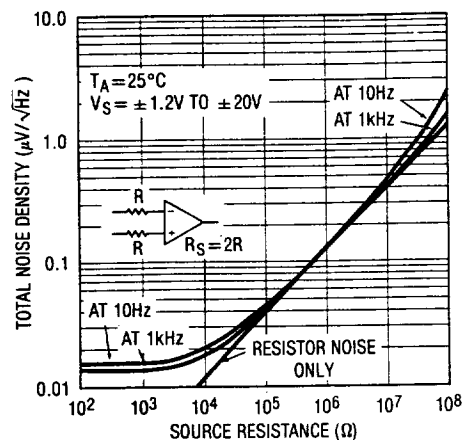

Supply Current vs Supply Voltage

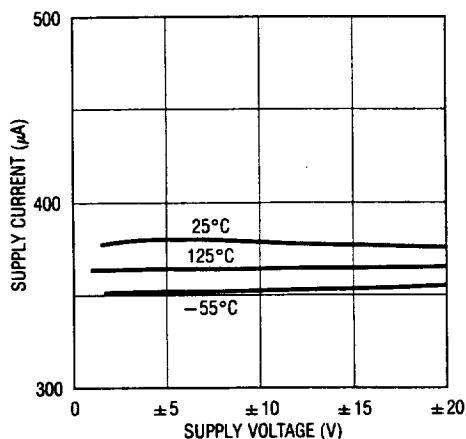

Common Mode Rejection vs Frequency

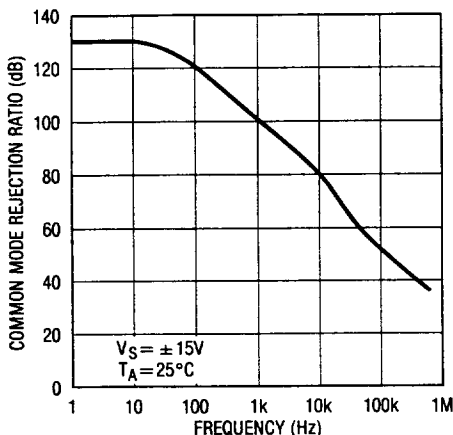

Power Supply Rejection vs Frequency

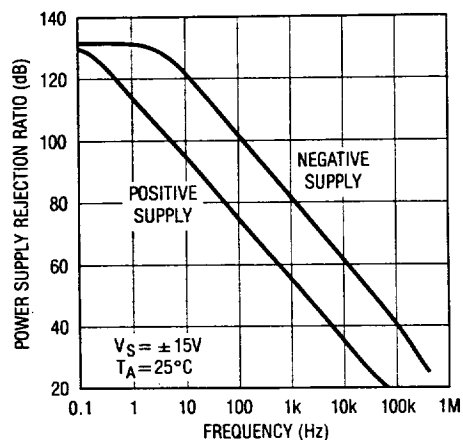

Voltage Gain vs Frequency

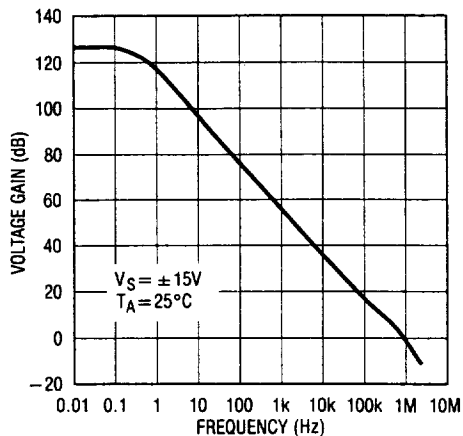

Gain, Phase Shift vs Frequency

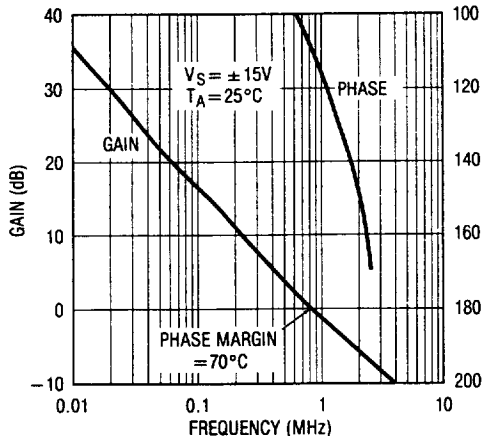

Voltage Gain vs Load Resistance

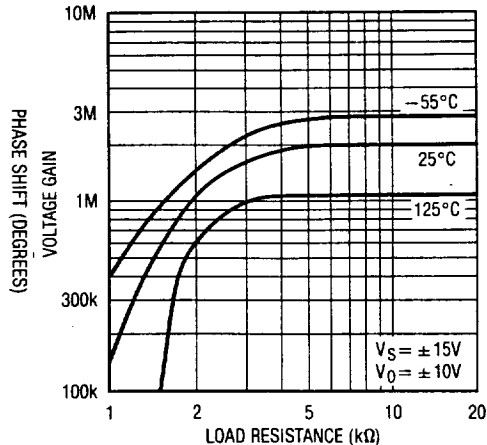

TYPICAL PERFORMANCE CHARACTERISTICS

Small Signal Transient Response

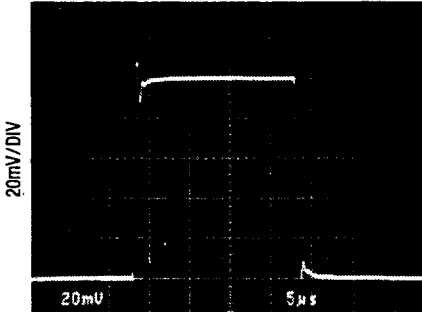

$A_V = +1$, $C_{LOAD} = 100pF$, $5\mu s/DIV$

Small Signal Transient Response

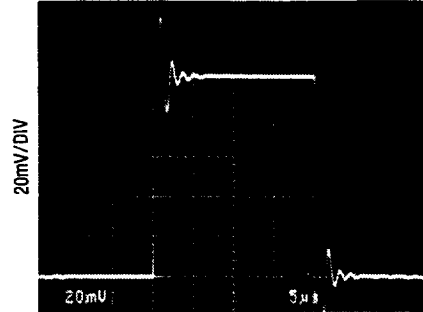

$A_V = +1$, $C_{LOAD} = 1000pF$, $5\mu s/DIV$

Large Signal Transient Response

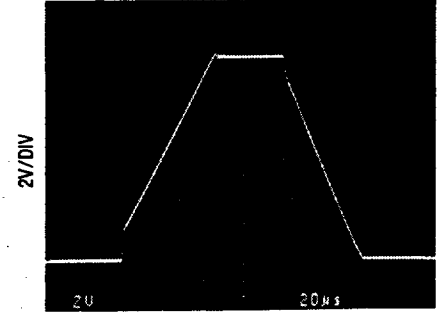

$A_V = +1$, $20\mu s/DIV$

Output Short Circuit Current vs Time

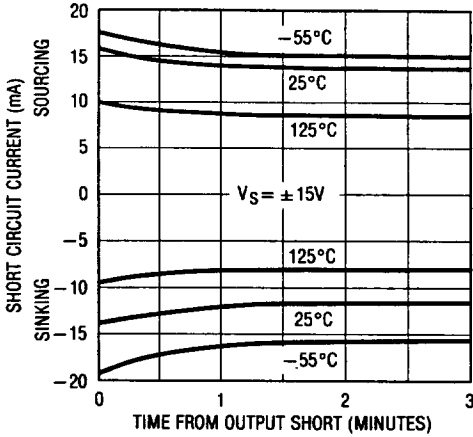

Slew Rate, Gain Bandwidth Product vs Over-Compensation Capacitor

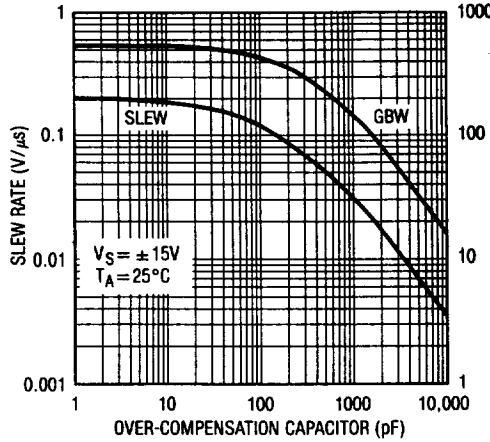

Closed Loop Output Impedance

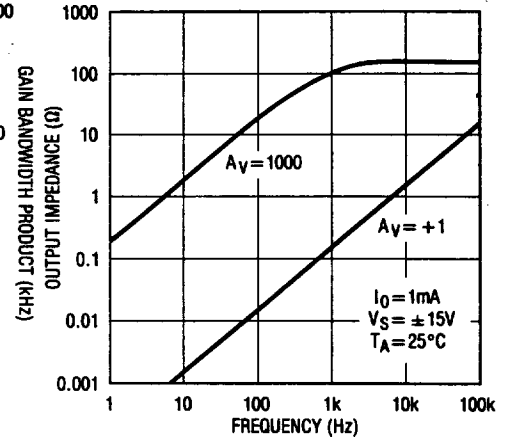

Common Mode Range and Voltage Swing at Minimum Supply Voltage

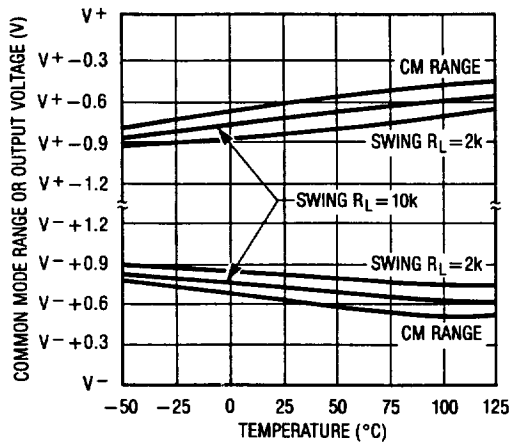

Minimum Supply Voltage, Voltage Gain at V_{MIN}

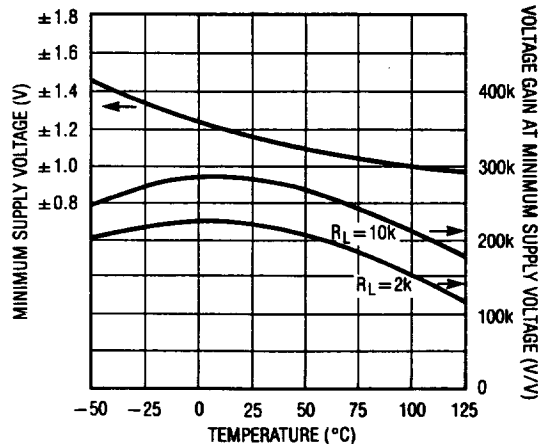

APPLICATIONS INFORMATION

The LT1012 may be inserted directly into OP-07, LM11, 108A or 101A sockets with or without removal of external frequency compensation or nulling components. The LT1012 can also be used in 741, LF411, LF156 or OP-15 applications provided that the nulling circuitry is removed.

Although the OP-97 is a copy of the LT1012, the LT1012 directly replaces and upgrades OP-97 applications. The LT1012C and D have lower offset voltage and drift than the OP-97F. The LT1012A has lower supply current than the OP-97A/E. In addition, all LT1012 grades guarantee operation at $\pm 1.2V$ supplies.

Achieving Picoampere/Microvolt Performance

In order to realize the picoampere/microvolt level accuracy of the LT1012, proper care must be exercised. For example, leakage currents in circuitry external to the op amp can significantly degrade performance. High quality insulation should be used (e.g. Teflon, Kel-F); cleaning of all insulating surfaces to remove fluxes and other residues will probably be required. Surface coating may be necessary to provide a moisture barrier in high humidity environments.

Board leakage can be minimized by encircling the input circuitry with a guard ring operated at a potential close to that of the inputs: in inverting configurations the guard ring should be tied to ground, in non-inverting connections to the inverting input at pin 2. Guarding both sides of the printed circuit

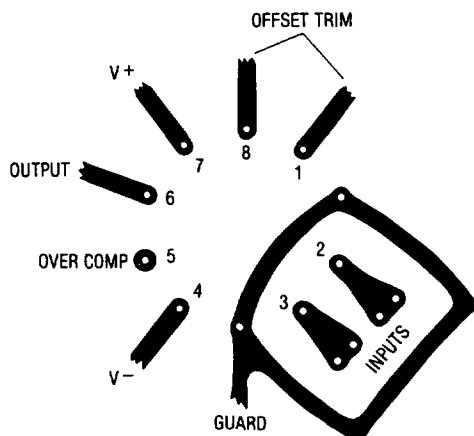

board is required. Bulk leakage reduction depends on the guard ring width. Nanoampere level leakage into the offset trim terminals can affect offset voltage and drift with temperature.

Microvolt level error voltages can also be generated in the external circuitry. Thermocouple effects caused by temperature gradients across dissimilar metals at the contacts to the input terminals can exceed the inherent drift of the amplifier. Air currents over device leads should be minimized, package leads should be short, and the two input leads should be as close together as possible and maintained at the same temperature.

Noise Testing

For application information on noise testing and calculations, please see the LT1008 data sheet.

Frequency Compensation

The LT1012 can be overcompensated to improve capacitive load handling capability or to narrow noise bandwidth. In many applications, the feedback loop around the amplifier has gain (e.g. logarithmic amplifiers); overcompensation can stabilize these circuits with a single capacitor.

The availability of the compensation terminal permits the use of feedforward frequency compensation to enhance slew rate. The voltage follower feedforward scheme bypasses the amplifier's gain stages and slews at nearly $10V/\mu s$.

The inputs of the LT1012 are protected with back-to-back diodes. Current limiting resistors are not used, because the leakage of these resistors would prevent the realization of picoampere level bias currents at elevated temperatures. In the voltage follower configuration, when the input is driven by a fast, large signal pulse ($>1V$), the input protection diodes effectively short the output to the input during slewing, and a current, limited only by the output short circuit protection will flow through the diodes.

TYPICAL APPLICATIONS

Kelvin-Sensed Platinum Temperature Sensor Amplifier

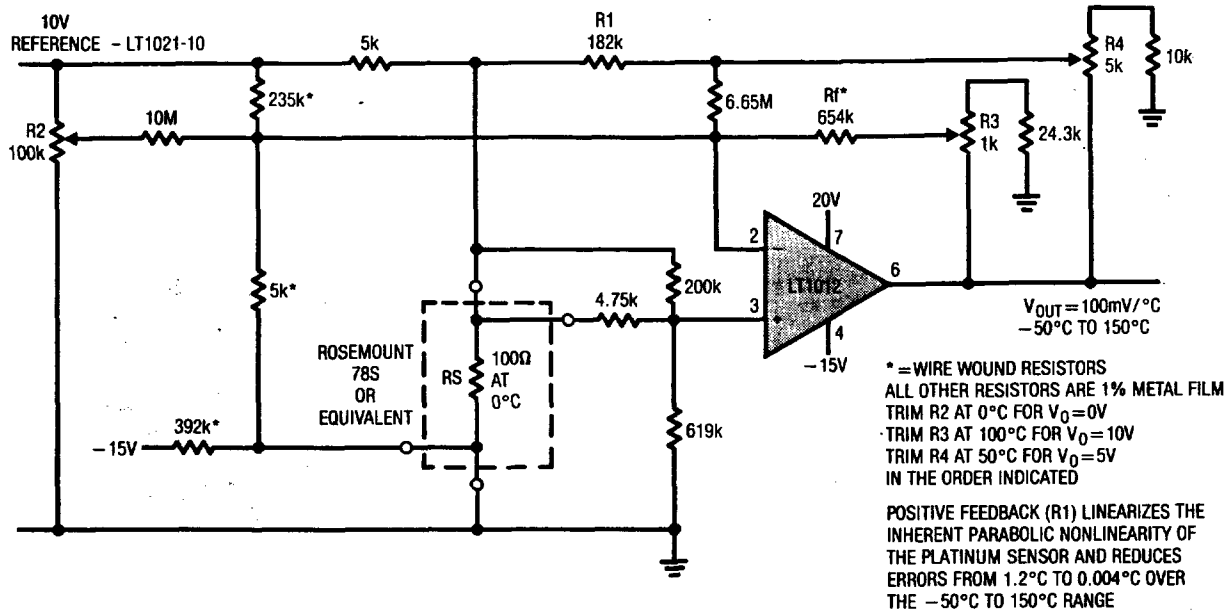

Saturated Standard Cell Amplifier

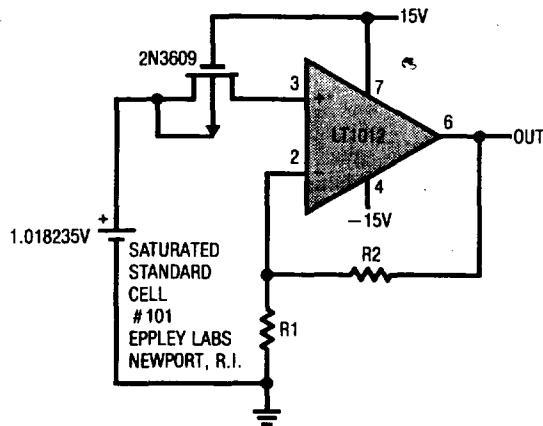

THE TYPICAL 30pA BIAS CURRENT OF THE LT1012 WILL DEGRADE THE STANDARD CELL BY ONLY 1ppm/YEAR. NOISE IS A FRACTION OF A ppm. UNPROTECTED GATE MOSFET ISOLATES STANDARD CELL ON POWER DOWN.

Amplifier for Bridge Transducers

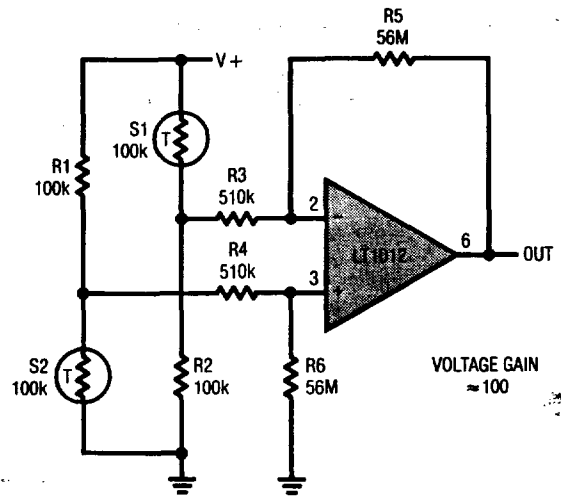

Amplifier for Photodiode Sensor

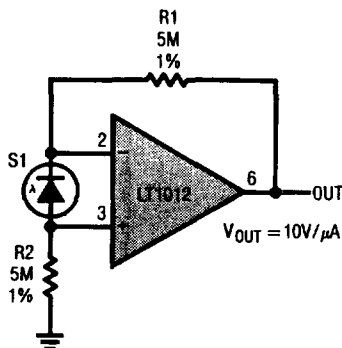

Buffered Reference for A to D Converters

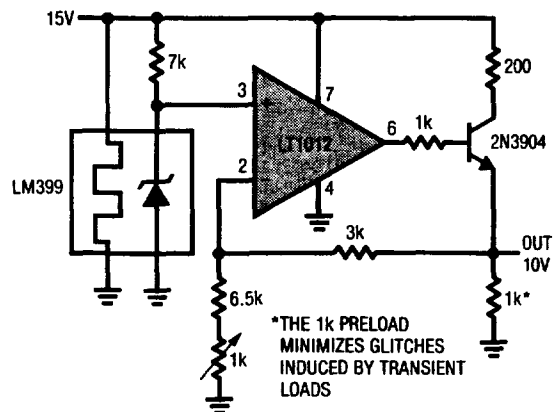

TYPICAL APPLICATIONS

Instrumentation Amplifier with ±100V Common Mode Range

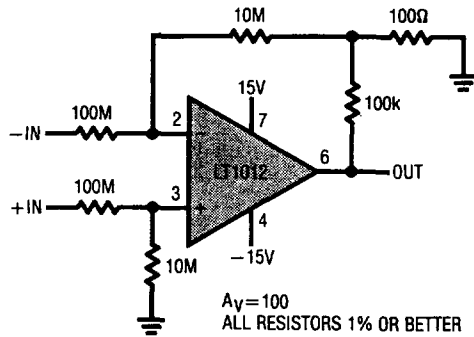

Low Power Comparator with <math>< 10\mu V</math> Hysteresis

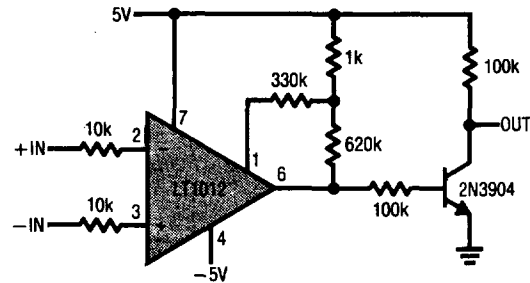

Air Flow Detector

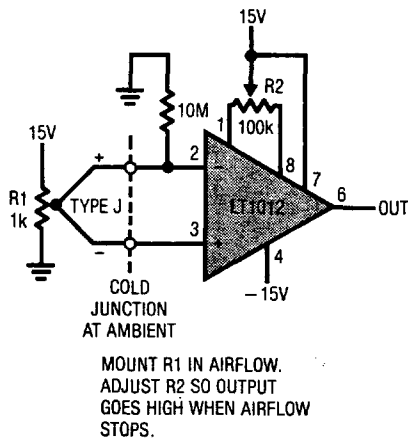

Input Amplifier for 4 1/2 Digit Voltmeter

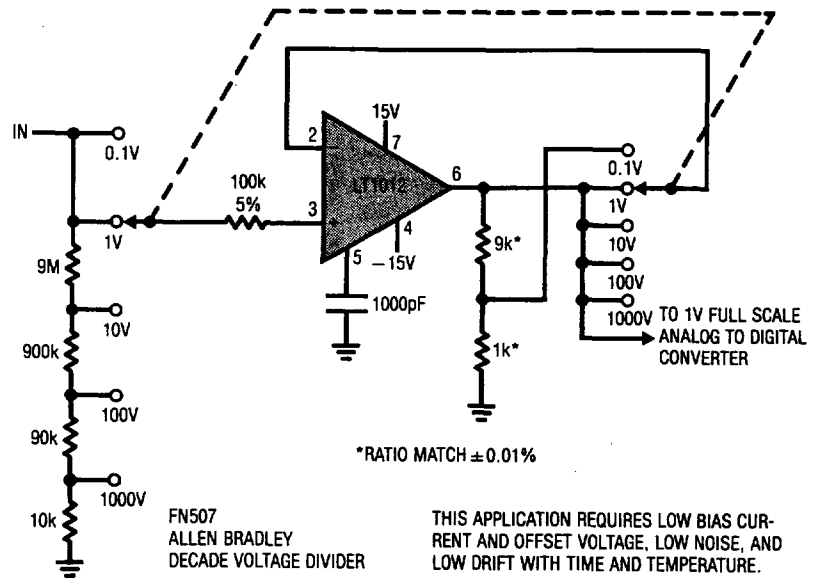

Resistor Multiplier

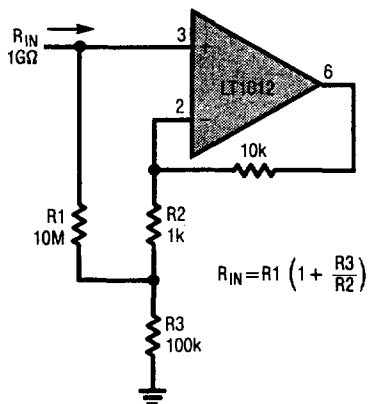

"No Trims" 12-Bit Multiplying DAC Output Amplifier

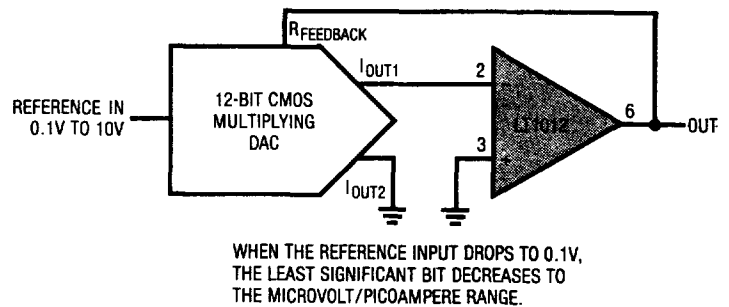

SCHEMATIC DIAGRAM

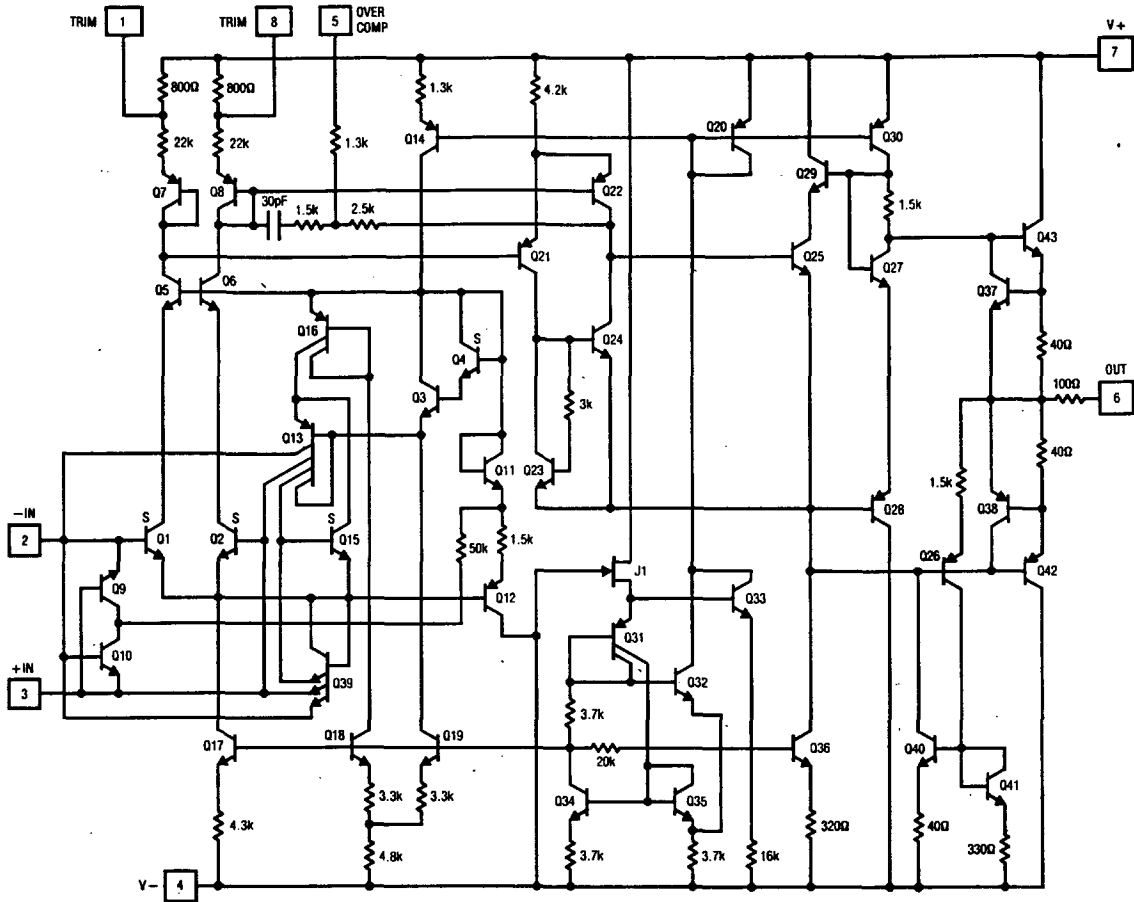

PACKAGE DESCRIPTION Dimensions in inches (millimeters) unless otherwise noted.

H Package
8-Lead TO-5 Metal Can

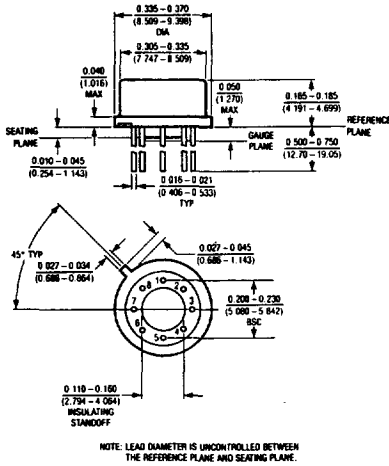

T_{JMAX}	θ_{JA}	θ_{JC}
150°C	150°C/W	45°C/W

N Package
8-Lead Plastic DIP

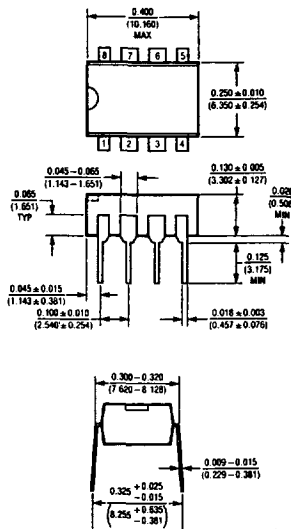

T_{JMAX}	θ_{JA}
100°C	130°C/W

SO Package
8-Lead Plastic SOIC

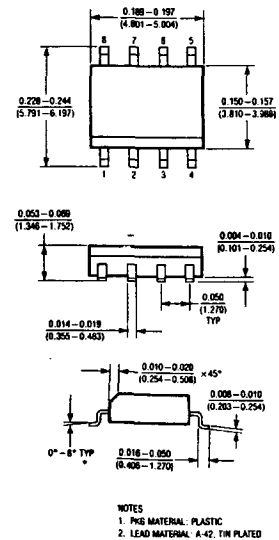

T_{JMAX}	θ_{JA}
100°C	170°C/W