

FEATURES

- **Guaranteed 20 ppm/°C Drift (H Package and Z Package)**
- **Guaranteed 40 ppm/°C Drift (SO-8 Package)**
- **20 μ A to 20mA Operation (1.2V)**
- **Dynamic Impedance: 1 Ω**
- **7V, 100 μ A Reference**

APPLICATIONS

- Portable Meters
- Precision Regulators
- Calibrators

DESCRIPTION

The LT[®]1034 is a micropower, precision 1.2V/2.5 reference combined with a 7V auxiliary reference. The 1.2V/2.5V reference is a trimmed, thin-film, band-gap, voltage reference with 1% initial tolerance and guaranteed 20ppm/°C temperature drift. Operating on only 20 μ A, the LT1034 offers guaranteed drift, low temperature cycling hysteresis and good long-term stability. The low dynamic impedance makes the LT1034 easy to use from unregulated supplies. The 7V reference is a subsurface zener device for less demanding applications.

The LT1034 reference can be used as a high performance upgrade of the LM385 or LT1004, where guaranteed temperature drift is desired.

LT, LTC and LT are registered trademarks of Linear Technology Corporation.

TYPICAL APPLICATION AND BLOCK DIAGRAM

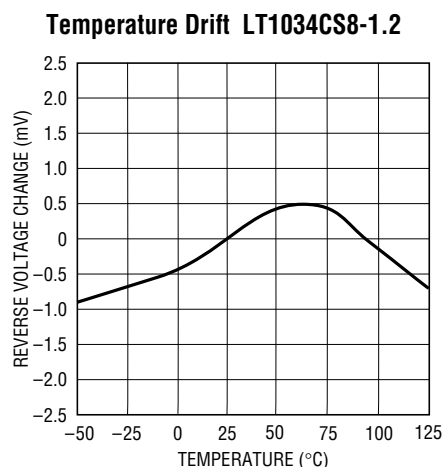
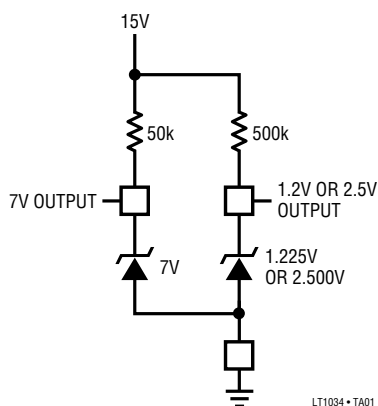

RELATED PARTS

PART NUMBER	DESCRIPTION	COMMENTS
LT1004	Low Cost Precision Band-Gap	Micropower, SO-8, Industrial Temperature Options
LT1019	Precision Series or Shunt Band-Gap	Low Dropout, Multiple Output Options
LT1236	Precision Series or Shunt Buried Zener	Low Noise, Low Power, Multiple Output Options

LT1034-1.2/LT1034-2.5

ABSOLUTE MAXIMUM RATINGS

Operating Current 20mA
 Forward Current (Note 1) 20mA
 Storage Temperature Range -65°C to 150°C
 Lead Temperature (Soldering, 10 sec) 300°C

Operating Temperature
 Commercial 0° to 70°C
 Industrial -40°C to 85°C
 Military -55°C to 125°C

PACKAGE/ORDER INFORMATION

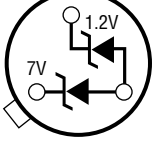
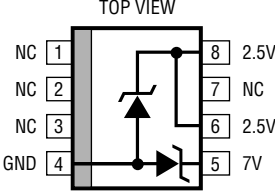
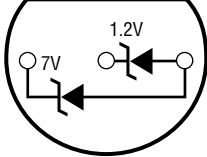
 <p>BOTTOM VIEW</p> <p>H PACKAGE 3-LEAD TO-46 METAL CAN T_{JMAX} = 150°C, θ_{JA} = 440°C/W, θ_{JC} = 80°C/W</p>	ORDER PART NUMBER	 <p>TOP VIEW</p> <p>S8 PACKAGE 8-LEAD PLASTIC SO T_{JMAX} = 175°C, θ_{JA} = 150°C/W</p>	ORDER PART NUMBER
	LT1034BCH-1.2 LT1034BCH-2.5 LT1034BMH-1.2 LT1034BMH-2.5 LT1034CH-1.2 LT1034CH-2.5 LT1034MH-1.2 LT1034MH-2.5		LT1034CS8-1.2 LT1034CS8-2.5 LT1034IS8-1.2 LT1034IS8-2.5
 <p>BOTTOM VIEW</p> <p>Z PACKAGE 3-LEAD TO-92 PLASTIC T_{JMAX} = 100°C, θ_{JA} = 160°C/W</p>	ORDER PART NUMBER		PART MARKING
	LT1034BCZ-1.2 LT1034BCZ-2.5 LT1034BIZ-1.2 LT1034BIZ-2.5 LT1034CZ-1.2 LT1034CZ-2.5 LT1034IZ-1.2 LT1034IZ-2.5		3401 3402 34I01 34I02

ELECTRICAL CHARACTERISTICS

T_A = 25°C, unless otherwise specified.

PARAMETER	CONDITIONS		LT1034-1.2			LT1034-2.5			UNITS
			MIN	TYP	MAX	MIN	TYP	MAX	
Reverse Breakdown Voltage	I _R = 100μA	●	1.210	1.225	1.240	2.46	2.5	2.54	V
			1.205	1.225	1.245	2.43	2.5	2.57	V
Reverse Breakdown Change with Current	Note 3 2mA ≤ I _R ≤ 20mA	●		0.5	2.0		1.0	3.0	mV
		●		1.0	4.0		1.5	6.0	mV
		●		4.0	8.0		6.0	16.0	mV
		●		6.0	15.0		10.0	20.0	mV
Minimum Operating Current		●		10	20		15	30	μA
Temperature Coefficient	I _R = 100μA LT1034B LT1034	●		10	20		10	20	ppm/°C
				20	40		20	40	ppm/°C
Reverse Dynamic Impedance (Note 2)	I _R = 100μA	●		0.25	1.0		0.5	1.5	Ω
				0.50	2.0		1.0	2.5	Ω
Low Frequency Noise	I _R = 100μA, 0.1Hz ≤ F ≤ 10Hz	●		4			6	μV _{p-p}	
Long-Term Stability	I _R = 100μA			20			20	ppm√khrs	

ELECTRICAL CHARACTERISTICS 7V Reference. $T_A = 25^\circ\text{C}$, unless otherwise specified.

PARAMETER	CONDITIONS	MIN	TYP	MAX	UNITS	
Reverse Breakdown Voltage	$I_R = 100\mu\text{A}$	●	6.80	7.0	7.3	V
			6.75	7.0	7.4	V
Reverse Breakdown Change with Current	$100\mu\text{A} \leq I_R \leq 1\text{mA}$		90	140	mV	
	$100\mu\text{A} \leq I_R \leq 1\text{mA}$	●	100	190	mV	
	$1\text{mA} \leq I_R \leq 20\text{mA}$	●	160	250	mV	
	$1\text{mA} \leq I_R \leq 20\text{mA}$	●	200	350	mV	
Temperature Coefficient	$I_R = 100\mu\text{A}$	●	40		ppm/ $^\circ\text{C}$	
Long-Term Stability	$I_R = 100\mu\text{A}$		20		ppm/ $\sqrt{\text{khrs}}$	

The ● denotes specifications which apply over the full operating temperature range.

Note 1: Forward biasing either diode will affect the operation of the other diode.

Note 2: This parameter guaranteed by “reverse breakdown change with current” test.

Note 3: For the LT1034-1.2: $20\mu\text{A} \leq I_R \leq 2\text{mA}$. For the LT1034-2.5: $30\mu\text{A} \leq I_R \leq 2\text{mA}$.

TYPICAL PERFORMANCE CHARACTERISTICS

Reverse Voltage Change 1.2V

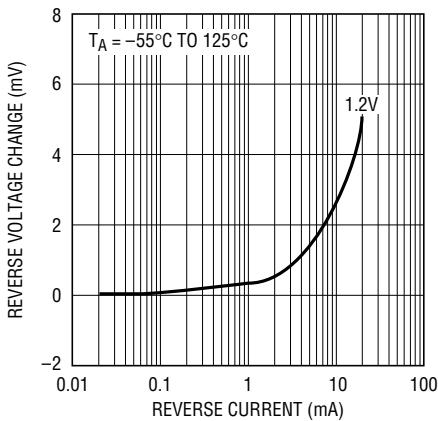

LT1034 • TPC01

Reverse Voltage Change 7V

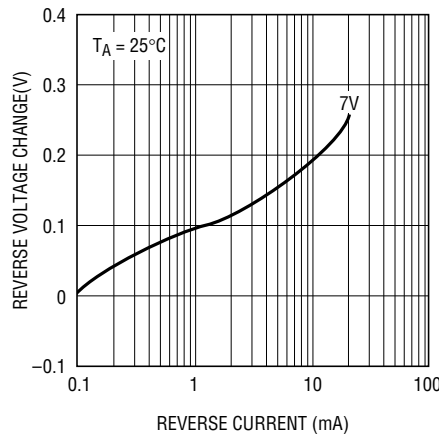

LT1034 • TPC02

0.1Hz to 10Hz Noise 1.2V

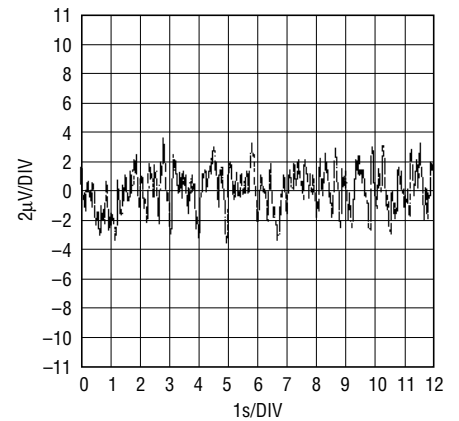

LT1034 • TPC03

Reverse Dynamic Impedance 1.2V

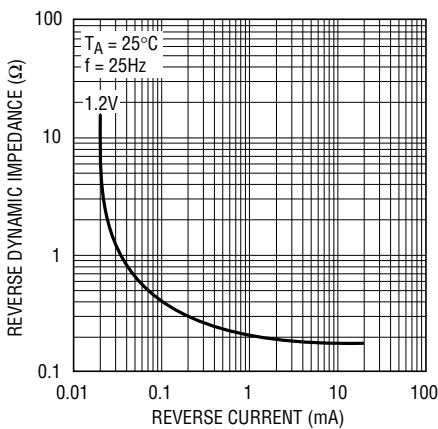

LT1034 • TPC04

Reverse Dynamic Impedance 2.5V

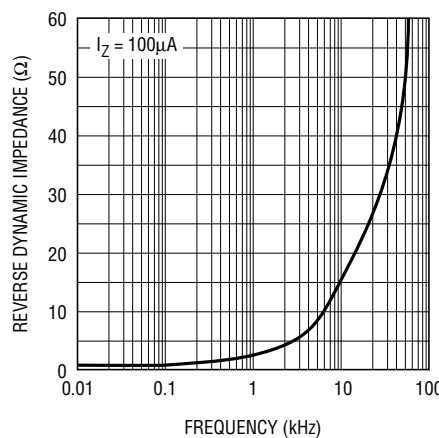

LT1034 • TPC05

Reverse Dynamic Impedance 7V

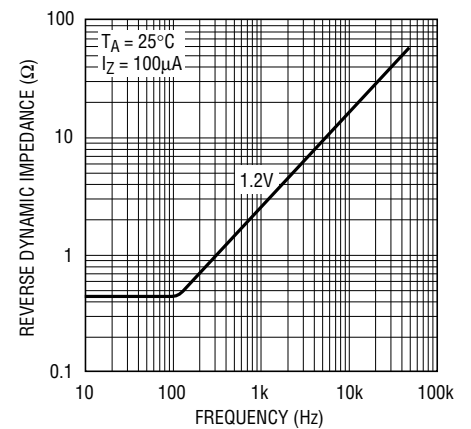

LT1034 • TPC06

TYPICAL PERFORMANCE CHARACTERISTICS

Reverse Characteristics 1.2V

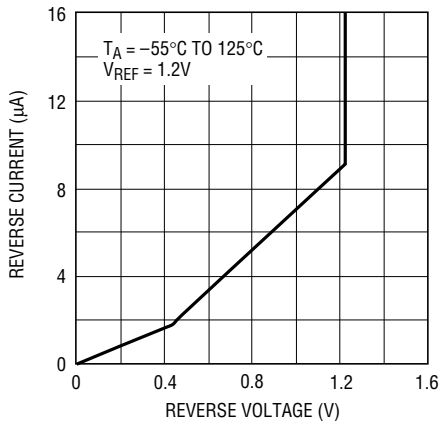

LT1034 • TPC07

Reverse Characteristics 2.5V

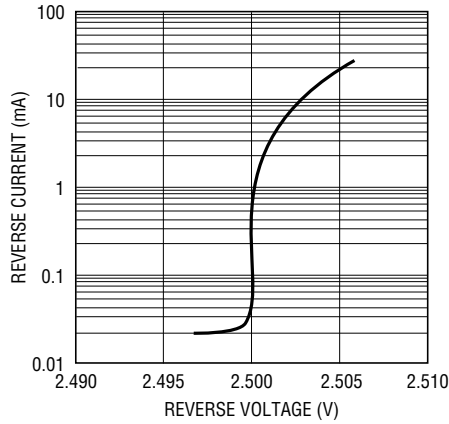

LT1034 • TPC02

Reverse Characteristics 7V

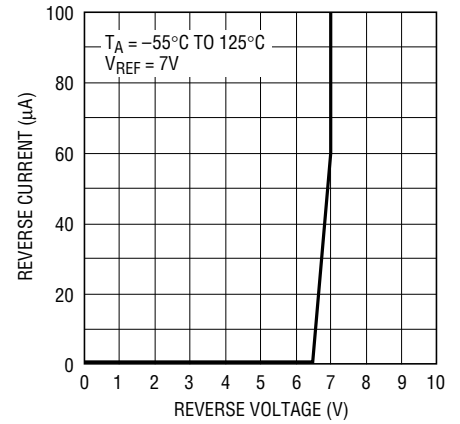

LT1034 • TPC09

Forward Characteristics

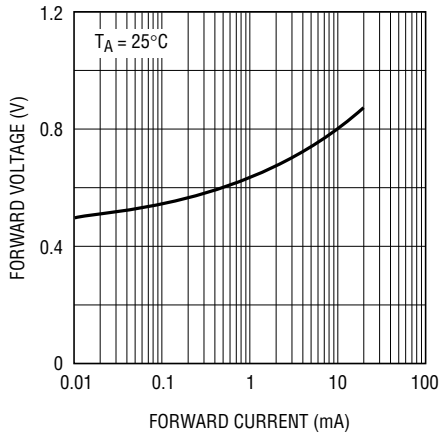

LT1034 • TPC10

Response Time

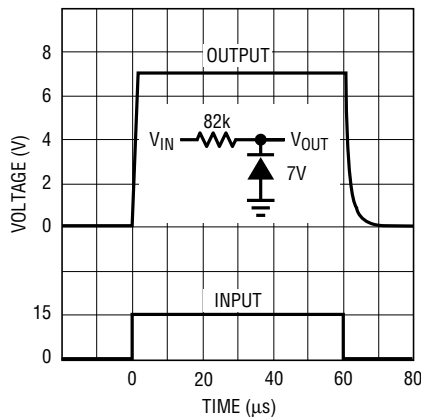

LT1180A • TPC11

Response Time

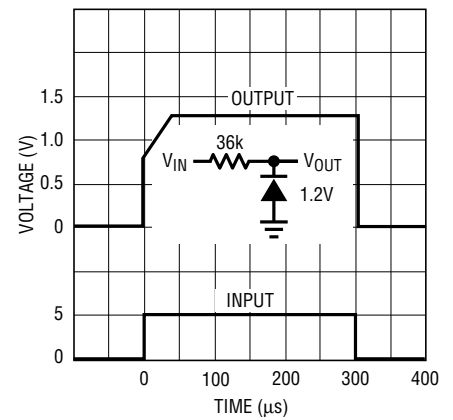

LT1180A • TPC12

PACKAGE DESCRIPTION

Dimension in inches (millimeters) unless otherwise noted.

H Package
Metal Can

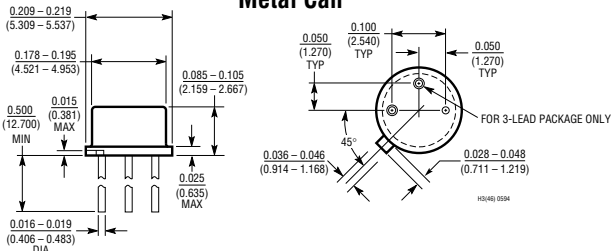

S8 Package
8-Lead Plastic SO

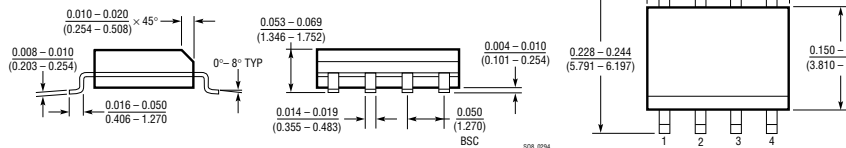

*THESE DIMENSIONS DO NOT INCLUDE MOLD FLASH OR PROTRUSIONS.
MOLD FLASH OR PROTRUSIONS SHALL NOT EXCEED 0.006 INCH (0.15mm).

Z Package
Plastic

