

## FEATURES

- 60 $\mu$ A Max Supply Current
- 40 $\mu$ V Max Offset Voltage
- 350pA Max Offset Current
- 0.5 $\mu$ Vp-p 0.1Hz to 10Hz Voltage Noise
- 2.5pAp-p 0.1Hz to 10Hz Current Noise
- 0.4 $\mu$ V/ $^{\circ}$ C Offset Voltage Drift
- 250kHz Gain-Bandwidth-Product
- 0.12V/ $\mu$ s Slew Rate
- Single Supply Operation
  - Input Voltage Range Includes Ground
  - Output Swings to Ground while Sinking Current
  - No Pull-Down Resistors are Needed
- Output Sources and Sinks 5mA Load Current

## APPLICATIONS

- Replaces OP-07, OP-77, AD707, LT1001, LT1012 at 10 to 60 Times Lower Power
- Battery or Solar Powered Systems
- 4mA to 20mA Current Loops
- Two Terminal Current Source
- Megaohm Source Resistance Difference Amplifier

## DESCRIPTION

The LT1077 is a micropower precision operational amplifier optimized for single supply operation at 5V.  $\pm 15$ V specifications are also provided.

Micropower performance of competing devices is achieved at the expense of seriously degrading precision, noise, speed, and output drive specifications. The LT1077 reduces supply current without sacrificing other parameters. The offset voltage achieved is the lowest of any micropower op amp. Offset current, voltage and current noise, slew rate and gain-bandwidth product are all two to ten times better than on previous micropower op amps.

The  $1/f$  corner of the voltage noise spectrum is at 0.7Hz. This results in low frequency (0.1Hz to 10Hz) noise performance which can only be found on devices with an order of magnitude higher supply current.

The LT1077 is completely plug-in compatible (including nulling) with all industry standard precision op amps. Thus, it can replace these precision op amps in many applications without sacrificing performance, yet with significant power savings.

The LT1077 can be operated from one lithium cell or two Ni-Cad batteries. The input range goes below ground. The all-NPN output stage swings to ground while sinking current—no pull-down resistors are needed.

For dual and quad op amps with similar specifications please see the LT1078/LT1079 datasheet.

Self Buffered Micropower Reference

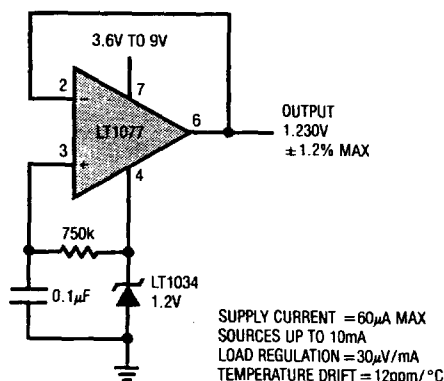

Distribution of Input Offset Voltage

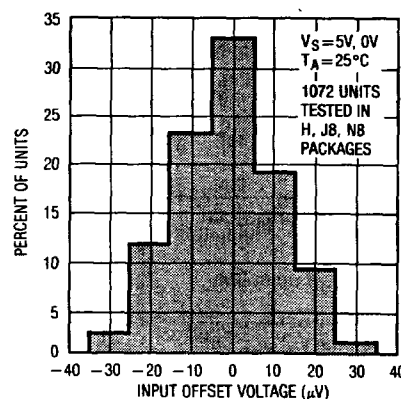

# LT1077

## ABSOLUTE MAXIMUM RATINGS

Supply Voltage .....	$\pm 22V$
Differential Input Voltage .....	$\pm 30V$
Input Voltage .....	Equal to Positive Supply Voltage
	..... 5V Below Negative Supply Voltage
Output Short Circuit Duration .....	Indefinite
Operating Temperature Range	
LT1077AM/LT1077M .....	$-55^{\circ}C$ to $125^{\circ}C$
LT1077AI/LT1077I .....	$-40^{\circ}C$ to $85^{\circ}C$
LT1077AC/LT1077C/LT1077S8 .....	$0^{\circ}C$ to $70^{\circ}C$
Storage Temperature Range	
All Grades .....	$-65^{\circ}C$ to $150^{\circ}C$
Lead Temperature (Soldering, 10 sec.) .....	$300^{\circ}C$

## PACKAGE/ORDER INFORMATION

<p>TOP VIEW H PACKAGE 8-LEAD TO-5 METAL CAN</p>	ORDER PART NUMBER	
	LT1077AMH LT1077MH LT1077ACH LT1077CH	
<p>TOP VIEW J PACKAGE 8-LEAD CERAMIC DIP    N PACKAGE 8-LEAD PLASTIC DIP</p>	LT1077AMJ8	LT1077AIN8
	LT1077MJ8	LT1077IN8
	LT1077ACJ8	LT1077ACN8
	LT1077CJ8	LT1077CN8
<p>TOP VIEW SO PACKAGE 8-LEAD PLASTIC SOIC</p>	LT1077S8	
	PART MARKING	
	1077	

## ELECTRICAL CHARACTERISTICS $V_S = 5V, 0V, V_{CM} = 0.1V, V_O = 1.4V, T_A = 25^{\circ}C$ , unless noted.

SYMBOL	PARAMETER	CONDITIONS	LT1077AM/AI/AC			LT1077M/I/C/S8			UNITS
			MIN	TYP	MAX	MIN	TYP	MAX	
$V_{OS}$	Input Offset Voltage	LT1077S8		9	40		10	60	$\mu V$
							12	150	$\mu V$
$\frac{\Delta V_{OS}}{\Delta Time}$	Long Term Input Offset Voltage Stability			0.4			0.4		$\mu V/Mo$
$I_{OS}$	Input Offset Current			0.06	0.35		0.06	0.45	nA
$I_B$	Input Bias Current			7	9		7	11	nA
$e_n$	Input Noise Voltage	0.1Hz to 10Hz (Note 2)		0.5	1.1		0.5		$\mu Vp-p$
	Input Noise Voltage Density	$f_o = 10Hz$ (Note 2)		28	43		28		$nV/\sqrt{Hz}$
		$f_o = 1000Hz$ (Note 2)		27	35		27		$nV/\sqrt{Hz}$
$i_n$	Input Noise Current	0.1Hz to 10Hz (Note 2)		2.5	4.5		2.5		$pAp-p$
	Input Noise Current Density	$f_o = 10Hz$ (Note 2)		0.065	0.11		0.065		$pA/\sqrt{Hz}$
		$f_o = 1000Hz$		0.02			0.02		$pA/\sqrt{Hz}$
	Input Resistance	(Note 3)							$M\Omega$
	Differential Mode		350	700		270	700		$G\Omega$
	Common-Mode			6			6		
	Input Voltage Range		3.5	3.8		3.5	3.8		V
			0	-0.3		0	-0.3		V
CMRR	Common-Mode Rejection Ratio	$V_{CM} = 0V$ to $3.5V$	97	106		94	105		dB
PSRR	Power Supply Rejection Ratio	$V_S = 2.3V$ to $12V$	102	118		100	117		dB
$A_{VOL}$	Large Signal Voltage Gain	$V_O = 0.03V$ to $4V$ , No Load	300	1000		240	1000		V/mV
		$V_O = 0.03V$ to $3.5V, R_L = 50k$	250	1000		200	1000		V/mV

**ELECTRICAL CHARACTERISTICS**  $V_S = 5V, 0V, V_{CM} = 0.1V, V_O = 1.4V, T_A = 25^\circ C$ , unless noted.

SYMBOL	PARAMETER	CONDITIONS	LT1077AM/AI/AC			LT1077M/I/C/S8			UNITS
			MIN	TYP	MAX	MIN	TYP	MAX	
	Maximum Output Voltage Swing	Output Low, No Load		3.5	6		3.5	6	mV
		Output Low, 2k to GND		0.7	1.1		0.7	1.1	mV
		Output Low, $I_{SINK} = 100\mu A$		90	130		90	130	mV
		Output High, No Load	4.2	4.4		4.2	4.4		V
		Output High, 2k to GND	3.5	3.9		3.5	3.9		V
SR	Slew Rate	(Note 1)	0.05	0.08		0.05	0.08	V/ $\mu s$	
GBW	Gain Bandwidth Product	$f_o \leq 20kHz$		230			230	KHz	
$I_S$	Supply Current			48	60		48	68	$\mu A$
	Offset Adjustment Range	$R_{pot} = 10k$ , Wiper to $V^+$	$\pm 500$	$\pm 900$		$\pm 500$	$\pm 900$		$\mu V$
	Minimum Supply Voltage	(Note 4)		2.2	2.3		2.2	2.3	V

**ELECTRICAL CHARACTERISTICS**

$V_S = 5V, 0V, V_{CM} = 0.1V, V_O = 1.4V, -55^\circ C \leq T_A \leq 125^\circ C$  for AM/I grades,  $-40^\circ C \leq T_A \leq 85^\circ C$  for All grades.

2

SYMBOL	PARAMETER	CONDITIONS		LT1077AM/AI			LT1077M/I			UNITS
				MIN	TYP	MAX	MIN	TYP	MAX	
$V_{OS}$	Input Offset Voltage		●		50	200		60	260	$\mu V$
$\Delta V_{OS}/\Delta T$	Input Offset Voltage Drift	(Note 5)	●		0.4	1.6		0.5	2.0	$\mu V/^\circ C$
$I_{OS}$	Input Offset Current		●		0.08	0.60		0.08	0.80	nA
$I_B$	Input Bias Current		●		8	11		8	13	nA
CMRR	Common-Mode Rejection Ratio	$V_{CM} = 0.05V$ to $3.2V$	●	92	104		88	103		dB
PSRR	Power Supply Rejection Ratio	$V_S = 3.1V$ to $12V$	●	98	114		94	113		dB
$A_{VOL}$	Large Signal Voltage Gain	$V_O = 0.05V$ to $3.5V, R_L = 50k$	●	120	600		100	600		V/mV
	Maximum Output Voltage Swing	Output Low, No Load	●		4.5	8		4.5	8	mV
		Output Low, $I_{SINK} = 100\mu A$	●		120	170		120	170	mV
		Output High, No Load	●	3.9	4.2		3.9	4.2		V
		Output High, 2k to GND	●	3.0	3.7		3.0	3.7		V
$I_S$	Supply Current		●		54	80		54	90	$\mu A$

**ELECTRICAL CHARACTERISTICS**  $V_S = 5V, 0V, V_{CM} = 0.1V, V_O = 1.4V, 0^\circ C \leq T_A \leq 70^\circ C$ , unless noted.

SYMBOL	PARAMETER	CONDITIONS		LT1077AC			LT1077C/S8			UNITS
				MIN	TYP	MAX	MIN	TYP	MAX	
$V_{OS}$	Input Offset Voltage		●		30	110		35	150	$\mu V$
		LT1077S8	●					40	280	$\mu V$
$\Delta V_{OS}/\Delta T$	Input Offset Voltage Drift	(Note 5)	●		0.4	1.6		0.5	2.0	$\mu V/^\circ C$
		LT1077S8 (Note 5)						0.7	3.0	$\mu V/^\circ C$
$I_{OS}$	Input Offset Current		●		0.07	0.45		0.07	0.60	nA
$I_B$	Input Bias Current		●		7	10		7	12	nA
CMRR	Common-Mode Rejection Ratio	$V_{CM} = 0V$ to $3.4V$	●	94	105		90	104		dB
PSRR	Power Supply Rejection Ratio	$V_S = 2.6V$ to $12V$	●	100	116		97	115		dB
$A_{VOL}$	Large Signal Voltage Gain	$V_O = 0.05V$ to $3.5V, R_L = 50k$	●	180	800		150	800		V/mV
	Maximum Output Voltage Swing	Output Low, No Load	●		4.0	7		4.0	7	mV
		Output Low, $I_{SINK} = 100\mu A$	●		100	150		100	150	mV
		Output High, No Load	●	4.1	4.3		4.1	4.3		V
		Output High, 2k to GND	●	3.3	3.8		3.3	3.8		V
$I_S$	Supply Current		●		52	70		52	80	$\mu A$

**ELECTRICAL CHARACTERISTICS**  $V_S = \pm 15V, T_A = 25^\circ C$ , unless noted.

SYMBOL	PARAMETER	CONDITIONS	LT1077AM/AI/AC			LT1077M/I/C/S8			UNITS
			MIN	TYP	MAX	MIN	TYP	MAX	
$V_{OS}$	Input Offset Voltage	LT1077S8		20	150		25	200	$\mu V$
						30	300	$\mu V$	
$I_{OS}$	Input Offset Current			0.06	0.35		0.06	0.45	nA
$I_B$	Input Bias Current			7	9		7	11	nA
	Input Voltage Range		13.5	13.8		13.5	13.8		V
			-15.0	-15.3		-15.0	-15.3		V
CMRR	Common-Mode Rejection Ratio	$V_{CM} + 13.5V, -15V$	100	109		97	108		dB
PSRR	Power Supply Rejection Ratio	$V_S = 5V, 0V$ to $\pm 18V$	106	122		103	120		dB
$A_{VOL}$	Large Signal Voltage Gain	$V_O = \pm 10V, R_L = 50k$ $V_O = \pm 10V, R_L = 2k$	1000	8000		800	8000		V/mV
			400	1500		300	1500		V/mV
$V_{OUT}$	Maximum Output Voltage Swing	$R_L = 50k$ $R_L = 2k$	$\pm 13.0$	$\pm 14.0$		$\pm 13.0$	$\pm 14.0$		V
			$\pm 11.0$	$\pm 13.2$		$\pm 11.0$	$\pm 13.2$		V
SR	Slew Rate		0.07	0.12		0.07	0.12		V/ $\mu s$
$I_S$	Supply Current			56	75		56	85	$\mu A$

**ELECTRICAL CHARACTERISTICS**

$V_S = \pm 15V, -55^\circ C \leq T_A \leq 125^\circ C$  for AM/M grades,  $-40^\circ C \leq T_A \leq 85^\circ C$  for AI/I grades.

SYMBOL	PARAMETER	CONDITIONS	LT1077AM/AI			LT1077M/I			UNITS
			MIN	TYP	MAX	MIN	TYP	MAX	
$V_{OS}$	Input Offset Voltage		●	60	330		75	450	$\mu V$
$\Delta V_{OS}/\Delta T$	Input Offset Voltage Drift	(Note 5)	●	0.4	1.8		0.5	2.5	$\mu V/^\circ C$
$I_{OS}$	Input Offset Current		●	0.08	0.60		0.08	0.80	nA
$I_B$	Input Bias Current		●	8	11		8	13	nA
$A_{VOL}$	Large Signal Voltage Gain	$V_O = \pm 10V, R_L = 5k$	●	300	1000		250	1000	V/mV
CMRR	Common-Mode Rejection Ratio	$V_{CM} = +13V, -14.9V$	●	94	107		90	106	dB
PSRR	Power Supply Rejection Ratio	$V_S = 5V, 0V$ to $\pm 18V$	●	100	118		97	116	dB
	Maximum Output Voltage Swing	$R_L = 5k$	●	$\pm 11.0$	$\pm 13.5$		$\pm 11.0$	$\pm 13.5$	V
$I_S$	Supply Current		●	60	95		60	105	$\mu A$

**ELECTRICAL CHARACTERISTICS**  $V_S = \pm 15V, 0^\circ C \leq T_A \leq 70^\circ C$ , unless noted.

SYMBOL	PARAMETER	CONDITIONS	LT1077AC			LT1077C/S8			UNITS
			MIN	TYP	MAX	MIN	TYP	MAX	
$V_{OS}$	Input Offset Voltage	LT1077S8	●	40	230		50	320	$\mu V$
			●				65	450	$\mu V$
$\Delta V_{OS}/\Delta T$	Input Offset Voltage Drift	(Note 5) LT1077S8 (Note 5)	●	0.4	1.8		0.5	2.5	$\mu V/^\circ C$
							0.8	3.5	$\mu V/^\circ C$
$I_{OS}$	Input Offset Current		●	0.07	0.45		0.07	0.60	nA
$I_B$	Input Bias Current		●	7	10		7	12	nA
$A_{VOL}$	Large Signal Voltage Gain	$V_O = \pm 10V, R_L = 5k$	●	500	2000		400	2000	V/mV
CMRR	Common-Mode Rejection Ratio	$V_{CM} = 13V, -15V$	●	97	108		94	107	dB
PSRR	Power Supply Rejection Ratio	$V_S = 5V, 0V$ to $\pm 18V$	●	103	120		100	118	dB
	Maximum Output Voltage Swing	$R_L = 5k$	●	$\pm 11.0$	$\pm 13.6$		$\pm 11.0$	$\pm 13.6$	V
$I_S$	Supply Current		●	59	85		59	95	$\mu A$

The ● denotes the specifications which apply over the full operating temperature range.

**Note 1:** Slew rate at 5V, 0V is guaranteed by inference from the slew rate measurement at  $\pm 15V$ .

**Note 2:** This parameter is tested on a sample basis only. All noise parameters are tested with  $V_S = \pm 2.5V, V_O = 0V$ .

**Note 3:** This parameter is guaranteed by design and is not tested.

**Note 4:** Power supply rejection ratio is measured at the minimum supply voltage. The op amps actually work at 1.8V supply but with a typical offset skew of  $-300\mu V$ .

**Note 5:** This parameter is not 100% tested.

# TYPICAL PERFORMANCE CHARACTERISTICS

2

Supply Current vs Temperature

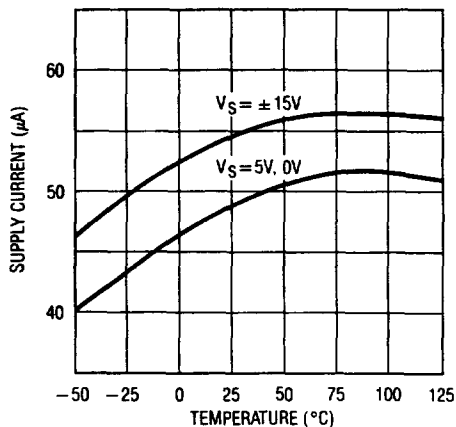

Input Bias and Offset Currents vs Temperature

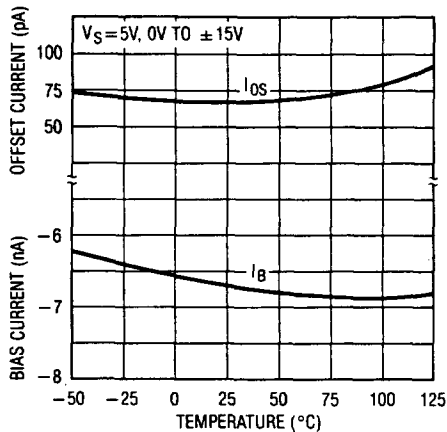

Input Bias Current vs Common-Mode Voltage

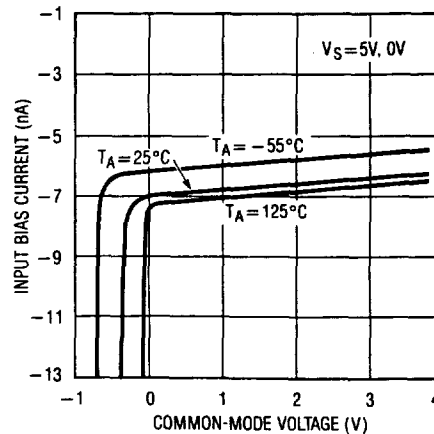

0.1Hz to 10Hz Noise

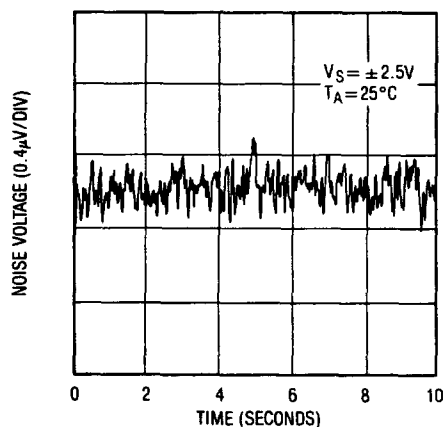

0.01Hz to 10Hz Noise

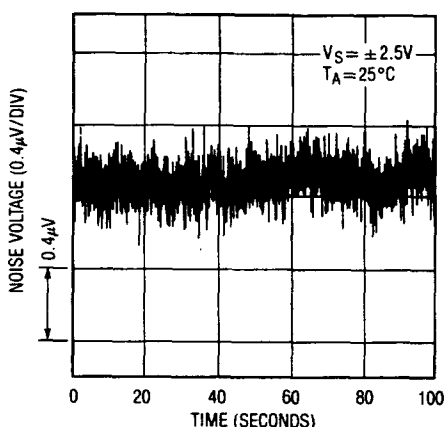

Noise Spectrum

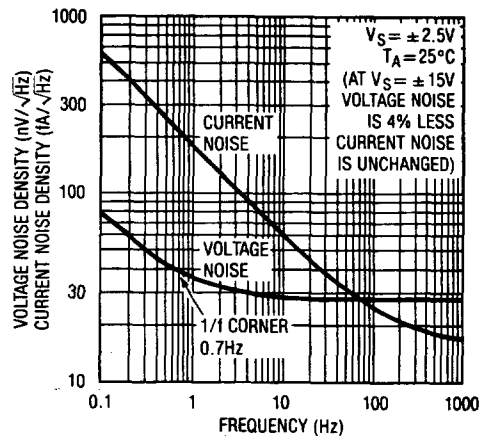

10Hz Voltage Noise Distribution

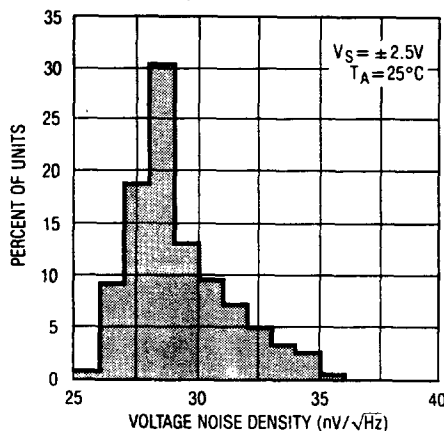

Distribution of Offset Voltage Drift with Temperature (In All Packages)

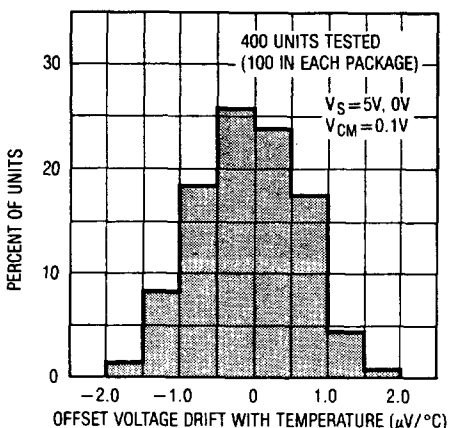

Distribution of Input Offset Voltage in Small Outline (S8) Package

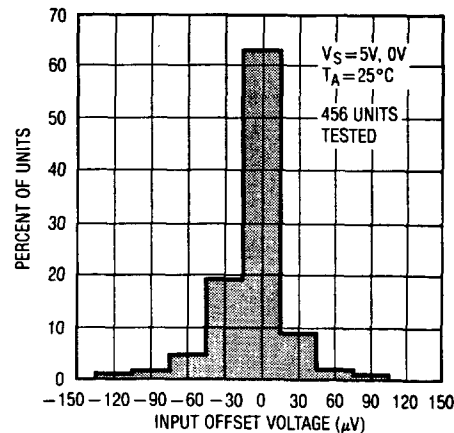

# TYPICAL PERFORMANCE CHARACTERISTICS

**Voltage Gain vs Frequency**

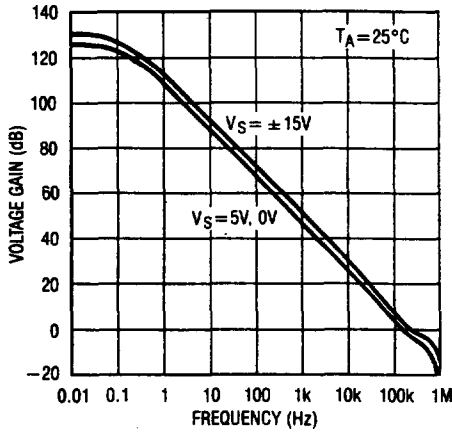

**Gain, Phase vs Frequency**

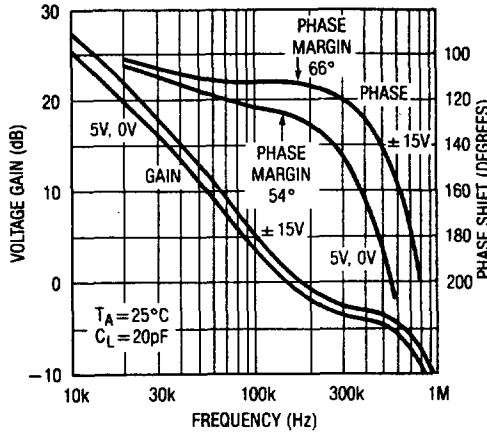

**Capacitive Load Handling**

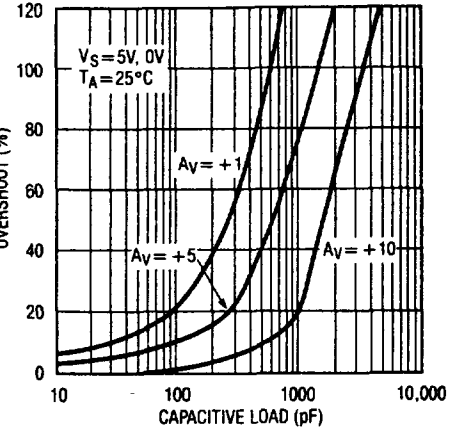

**Slew Rate, Gain Bandwidth Product and Phase Margin vs Temperature**

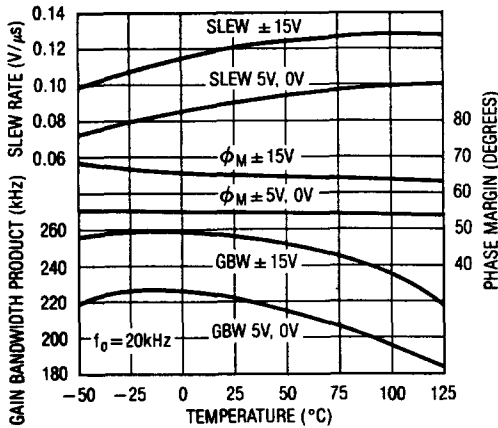

**Large Signal Transient Response VS = 5V, 0V**

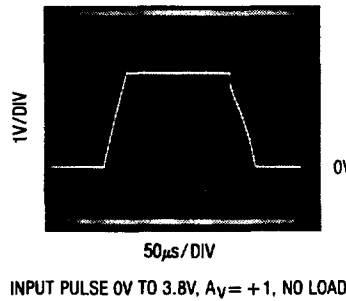

**Large Signal Transient Response VS = ±15V**

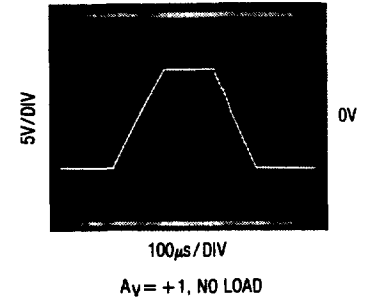

**Small Signal Transient Response VS = 5V, 0V**

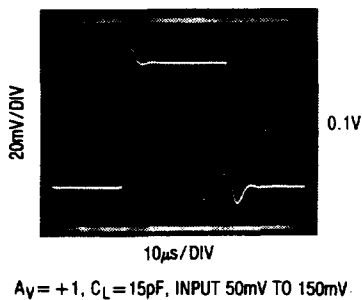

**Small Signal Transient Response VS = ±2.5V**

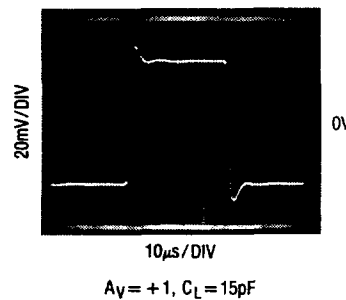

**Small Signal Transient Response VS = ±15V**

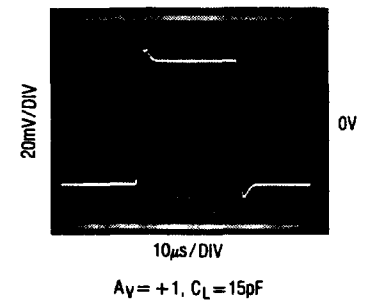

# TYPICAL PERFORMANCE CHARACTERISTICS

2

**Minimum Supply Voltage**

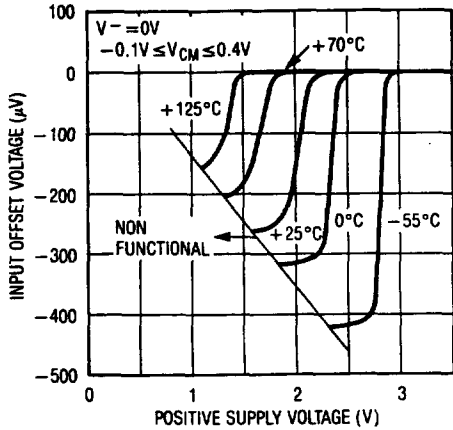

**Warm-Up Drift**

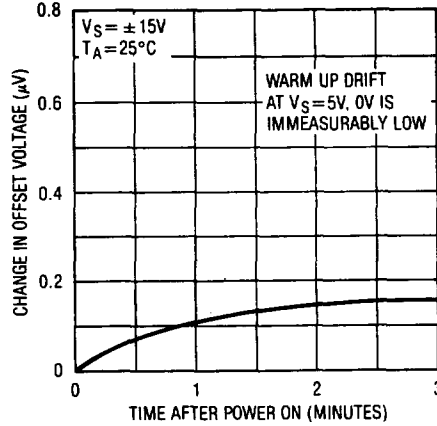

**Voltage Gain vs Load Resistance**

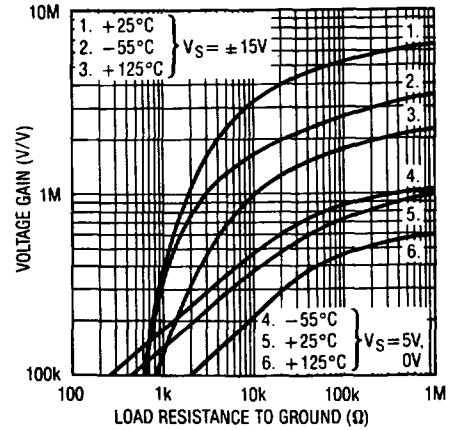

**Output Saturation vs Temperature vs Sink Current**

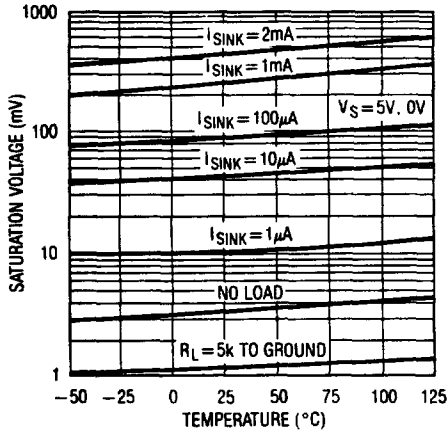

**Output Voltage Swing vs Load Current**

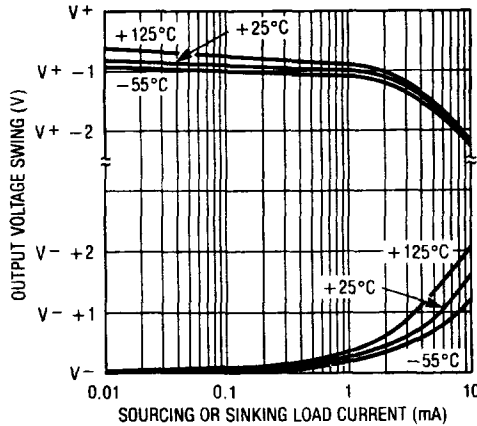

**Short Circuit Current vs Time**

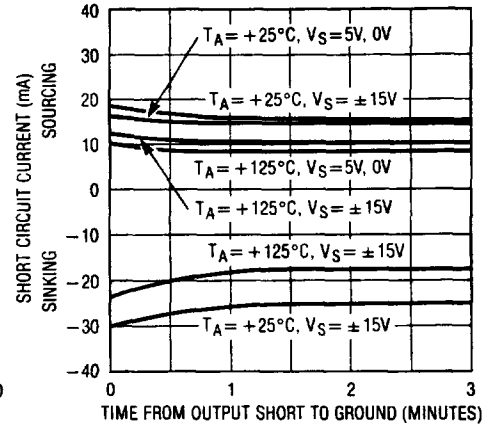

**Common-Mode Range vs Temperature**

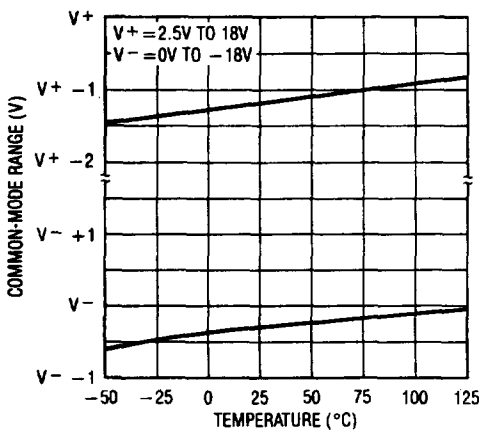

**Undistorted Output Swing vs Frequency**

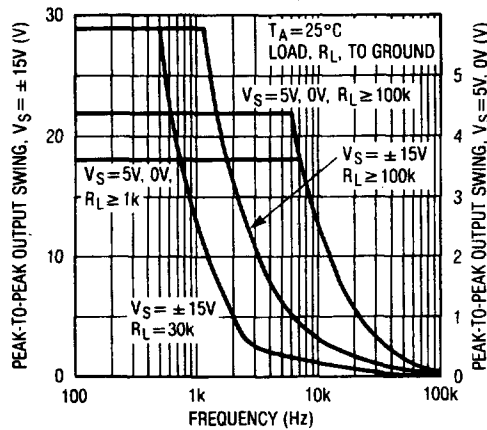

**Closed Loop Output Impedance**

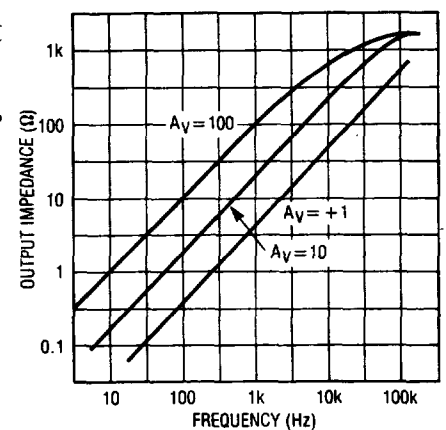

## TYPICAL PERFORMANCE CHARACTERISTICS

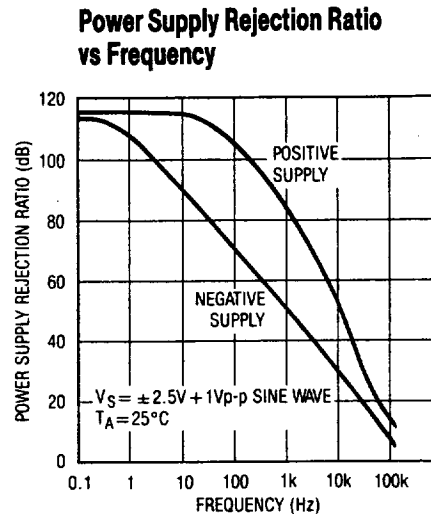
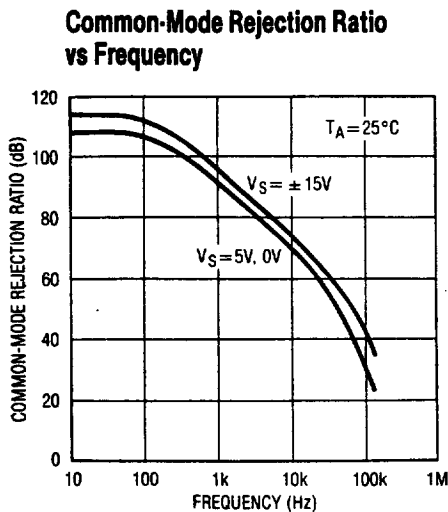

## APPLICATIONS INFORMATION

The LT1077 is fully specified with  $V^+ = 5\text{V}$ ,  $V^- = 0\text{V}$ ,  $V_{CM} = 0.1\text{V}$ . This set of operating conditions appears to be the most representative for battery powered micropower circuits. Offset voltage is internally trimmed to a minimum value at these supply voltages. When 9V or 3V batteries or  $\pm 2.5\text{V}$  dual supplies are used, bias and offset current changes will be minimal. Offset voltage changes will be just a few microvolts as given by the PSRR and CMRR specifications. For example, if  $\text{PSRR} = 114\text{dB}$  ( $= 2\mu\text{V/V}$ ), at 9V the offset voltage change will be  $8\mu\text{V}$ . Similarly,  $V_S = \pm 2.5\text{V}$ ,  $V_{CM} = 0$  is equivalent to a common-mode voltage change of 2.4V or a  $V_{OS}$  change of  $7\mu\text{V}$  if  $\text{CMRR} = 110\text{dB}$  ( $3\mu\text{V/V}$ ).

A full set of specifications is also provided at  $\pm 15\text{V}$  supply voltages for comparison with other devices and for completeness.

The LT1077 is pin compatible to, and directly replaces, such precision op amps as the OP-07, OP-77, AD707 and LT1001 with 30 to 60 times savings in supply current. The LT1077 is also a direct plug-in replacement for LT1012 and OP-97 devices with 10 times lower dissipation. Compatibility includes externally nulling the offset voltage, as all of the above devices are trimmed with a potentiometer between pins 1 and 8 and the wiper tied to  $V^+$ .

The LT1077 replaces and upgrades such micropower op amps as the OP-20, LM4250, and OP-90, provided that the

external nulling circuitry (and set resistor in the case of the LM4250) are removed. Since the offset voltage of the LT1077 is extremely low, nulling will be unnecessary in most applications.

### Single Supply Operation

The LT1077 is fully specified for single supply operation, i.e., when the negative supply is 0V. Input common-mode range goes below ground and the output swings within a few millivolts of ground while sinking current. All competing micropower op amps either cannot swing to within 600mV of ground (OP-20, OP-220, OP-420) or need a pull down resistor connected to the output to swing to ground (OP-90, OP-290, OP-490, HA5141/42/44). This difference is critical because in many applications these competing devices cannot be operated as micropower op amps and swing to ground simultaneously.

As an example, consider the difference amplifiers shown as Typical Applications. When the common-mode signal is high and the output low, the amplifier has to sink current. In the gain of 10 circuit, the competing devices require a 30k pull down resistor at the output to handle the specified signals. (The LT1077 does not need pull down resistors.) When the output is high the pull down resistor draws  $80\mu\text{A}$  which dominates the micropower current budget.

This situation is much worse in the gain of one circuit with  $V^- = 0\text{V}$ . At 100V common mode the output has to sink



## APPLICATIONS INFORMATION

2 $\mu$ A. At a minimum output voltage of 20mV competing devices require a 10k pull down resistor. As the output now swings to 10V, this resistor draws 1mA of current.

Since the output of the LT1077 cannot go exactly to ground, but can only approach ground to within a few millivolts, care should be exercised to ensure that the output is not saturated. For example, a 1mV input signal will cause the amplifier to set up in its linear region in the gain 100 configuration shown below, but is not enough to make the amplifier function properly in the voltage follower mode.

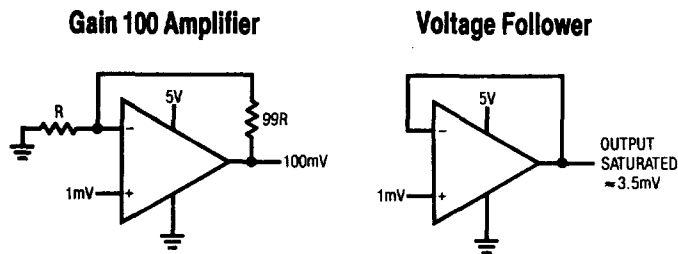

Voltage Follower with Input Exceeding the Negative Common-Mode Range ( $V_S = 5V, 0V$ )

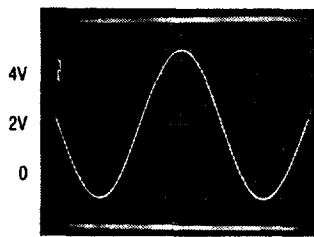

1ms / DIV  
6Vp-p INPUT, -1.0V TO +5.0V

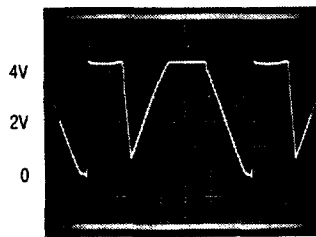

1ms / DIV  
OP-90 EXHIBITS OUTPUT  
PHASE REVERSAL

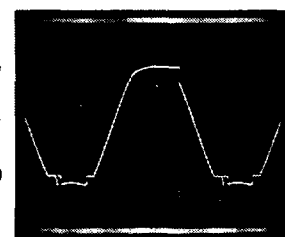

1ms / DIV  
LT1077  
NO PHASE REVERSAL

Single supply operation can also create difficulties at the input. The driving signal can fall below 0V—inadvertently or on a transient basis. If the input is more than a few hundred millivolts below ground, two distinct problems can occur on previous single supply designs, such as the LM124, LM158, OP-20, OP-21, OP-220, OP-221, OP-420 (a and b), OP-90/290/490 (b only):

a) When the input is more than a diode drop below ground, unlimited current will flow from the substrate ( $V^-$  terminal) to the input. This can destroy the unit. On the LT1077, resistors in series with the input protect the device even when the input is 5V below ground.

b) When the input is more than 400mV below ground (at 25°C), the input stage saturates and phase reversal occurs at the output. This can cause lock-up in servo systems. Due to a unique phase reversal protection circuitry, the LT1077's output does not reverse, as illustrated below, even when the input is at -1.0V.

2

## Comparator Applications

The single supply operation of the LT1077 and its ability to swing close to ground while sinking current lends itself to

use as a precision comparator with TTL compatible output.

Comparator Rise Response Time to 10mV, 5mV, 2mV Overdrives

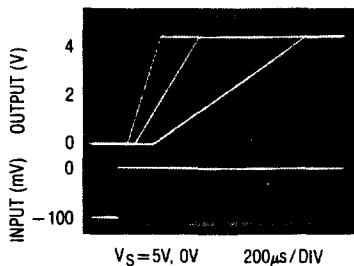

Comparator Fall Response Time to 10mV, 5mV, 2mV Overdrives

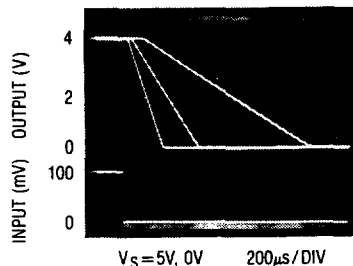

# TYPICAL APPLICATIONS

**Megaohm Input Impedance  
Gain of 10 Difference Amplifier**

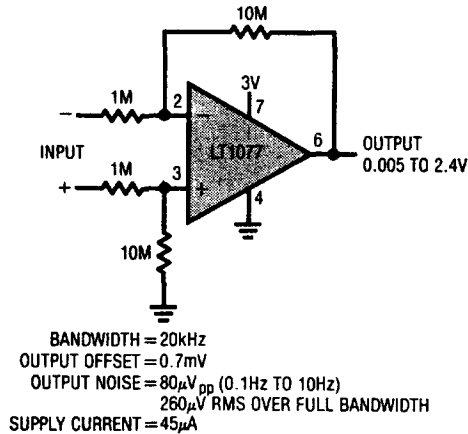

THE USEFULNESS OF DIFFERENCE AMPLIFIERS IS LIMITED BY THE FACT THAT THE INPUT RESISTANCE IS EQUAL TO THE SOURCE RESISTANCE. THE PICO-AMPERE OFFSET CURRENT AND LOW CURRENT NOISE OF THE LT1077 ALLOWS THE USE OF 1MΩ SOURCE RESISTORS WITHOUT DEGRADATION IN PERFORMANCE. IN ADDITION, WITH MEGA-OHM RESISTORS MICROPOWER OPERATION CAN BE MAINTAINED.

**±250V Common-Mode Range Difference Amplifier (A<sub>v</sub> = 1)**

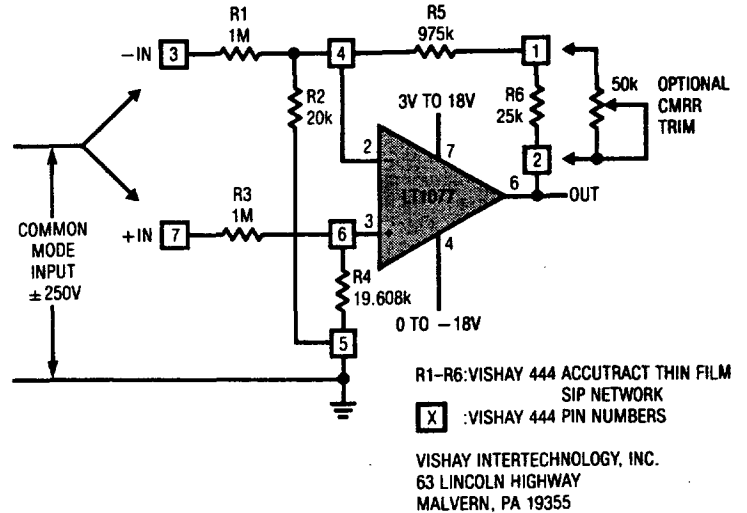

COMMON MODE REJECTION RATIO = 74dB (RESISTOR LIMITED)  
 WITH OPTIONAL TRIM = 108dB  
 OUTPUT OFFSET (TRIMMABLE TO ZERO) = 500µV  
 OUTPUT OFFSET DRIFT = 25µV/°C  
 INPUT RESISTANCE = 1M  
 COMMON MODE RANGE = ±250V, V<sub>+</sub> = 6.2V TO 18V, V<sub>-</sub> = -4.7V TO -18V  
 = ±100V, V<sub>+</sub> ≥ 3.2V, V<sub>-</sub> ≤ -1.8V  
 = +100V, -13V, V<sub>+</sub> ≥ 3.2V, V<sub>-</sub> = 0V

**Two Terminal Current Source**

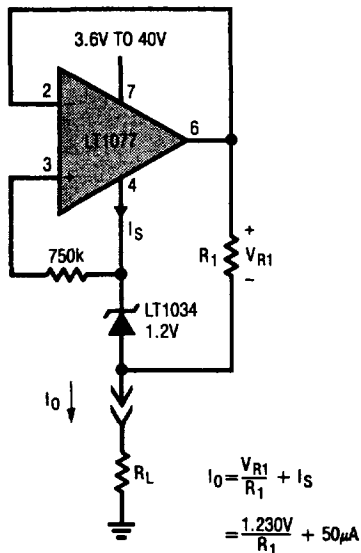

MINIMUM CURRENT = 50µA (R<sub>1</sub> = ∞)  
 MAXIMUM CURRENT = 10.3mA (R<sub>1</sub> = 120Ω)

**Half-Wave Rectifier**

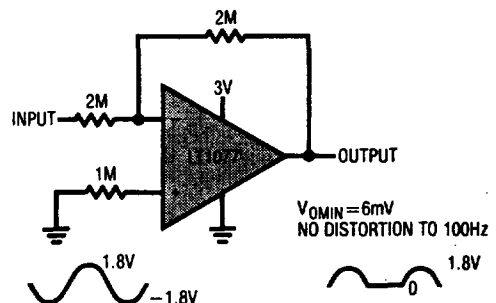

# SIMPLIFIED SCHEMATIC

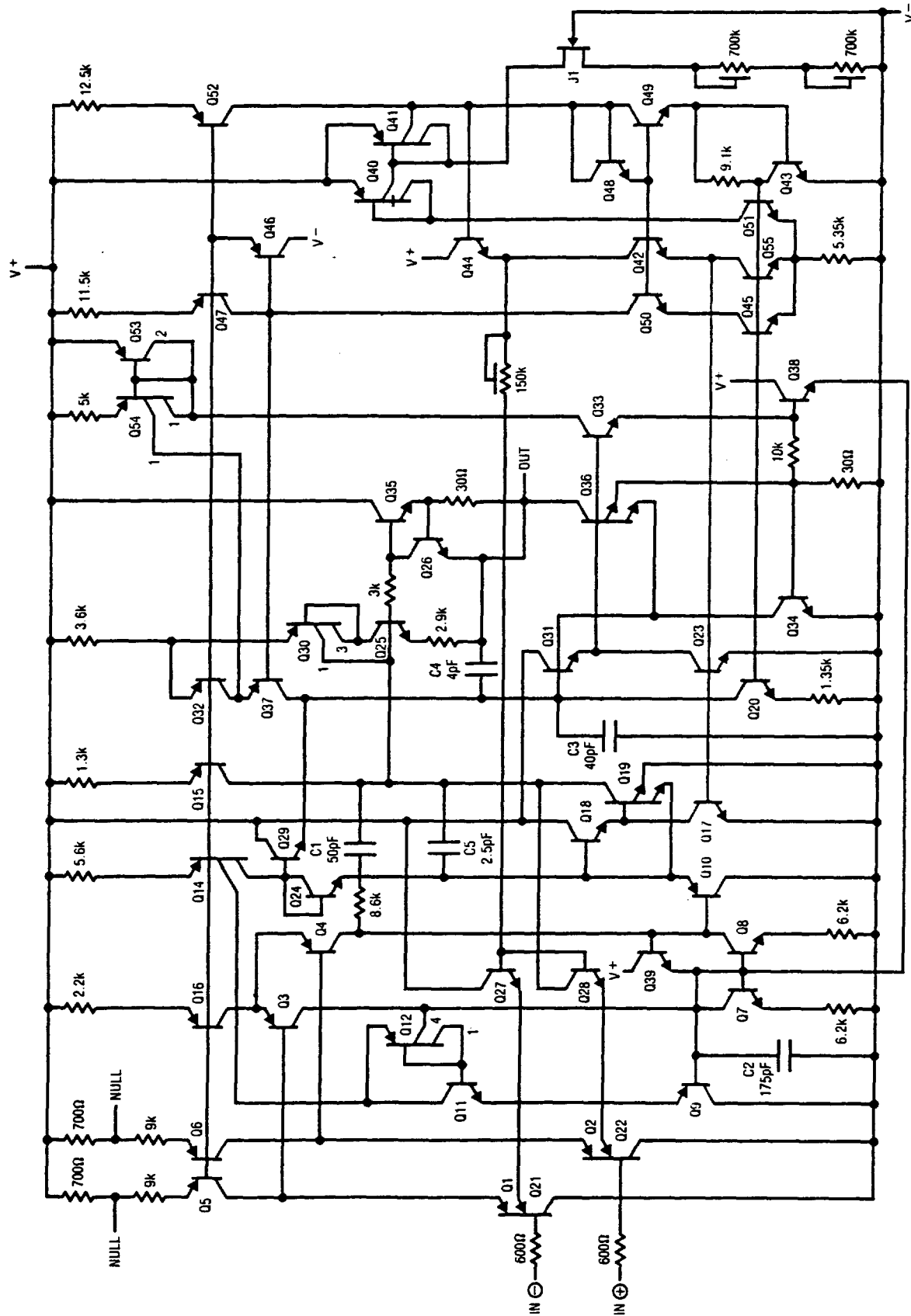

2