

Ultra High Speed Operational Amplifier

FEATURES

- Gain Bandwidth Product, $A_V = +1$ 50MHz
- Slew Rate 450V/ μ s
- Low Cost
- Output Current ± 50 mA
- Settling Time 140ns to 0.1%
- Differential Gain Error 0.1%, ($R_L = 1k$)
- Differential Phase Error 0.06°, ($R_L = 1k$)
- High Open Loop Gain 15V/mV Min
- Single Supply +5V Operation
- Output Shutdown

APPLICATIONS

- Video Cable Drivers
- Video Signal Processing
- Fast Integrators
- Pulse Amplifiers
- D/A Current to Voltage Conversion

DESCRIPTION

The LT1190 is a video operational amplifier optimized for operation on ± 5 V, and a single +5V supply. Unlike many high speed amplifiers, this amplifier features high open loop gain, over 85dB, and the ability to drive heavy loads to a full power bandwidth of 20MHz at 7Vp-p. In addition to its very fast slew rate, the LT1190 features a unity gain stable bandwidth of 50MHz, and a 75° phase margin, making it extremely easy to use.

Because the LT1190 is a true operational amplifier, it is an ideal choice for wideband signal conditioning, fast integrators, active filters, and applications requiring speed, accuracy, and low cost.

The LT1190 is available in 8-pin miniDIPs and SO packages with standard pinouts. The normally unused pin 5 is used for a shutdown feature that shuts off the output and reduces power dissipation to a mere 15mW.

Video MUX Cable Driver

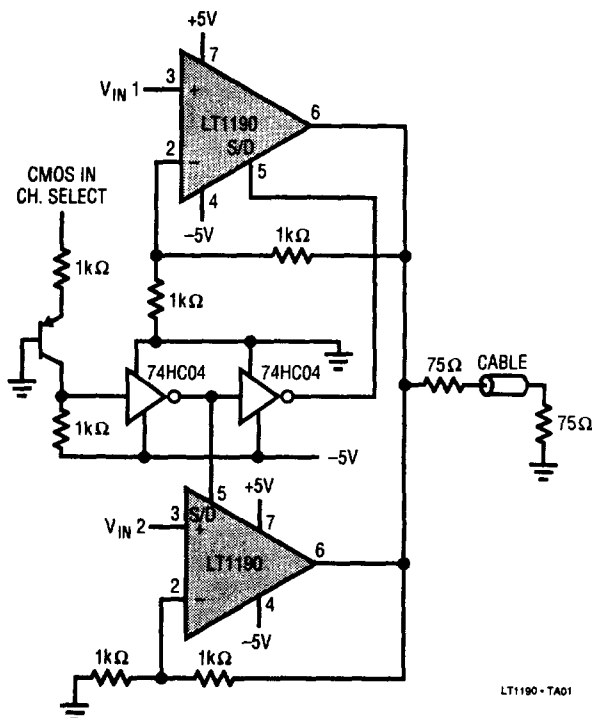

LT1190 - TA01

Inverter Pulse Response

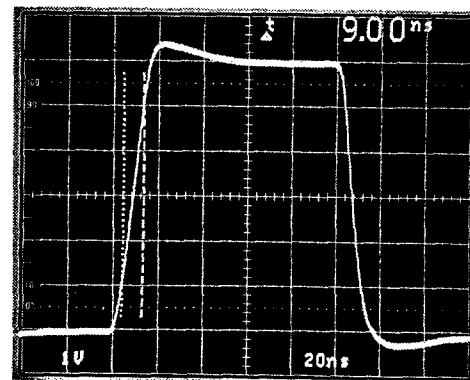

$A_V = -1$, $C_L = 10$ pF SCOPE PROBE

LT1190 - TA02

ABSOLUTE MAXIMUM RATINGS

Total Supply Voltage (V^+ to V^-)	18V
Differential Input Voltage	$\pm 6V$
Input Voltage	$\pm V_S$
Output Short Circuit Duration (Note 1)	Continuous
Operating Junction Temperature Range	
LT1190M	-55°C to 150°C
LT1190C	0°C to 150°C
Max. Junction Temperature	See Pkg. Descriptions
Storage Temperature Range	-65°C to 150°C
Lead Temperature (Soldering, 10 sec.)	300°C

PACKAGE/ORDER INFORMATION

	ORDER PART NUMBER
	LT1190MJ8 LT1190CJ8 LT1190CN8 LT1190CS8
	S8 PART MARKING
	1190

2

ELECTRICAL CHARACTERISTICS $V_S = \pm 5V$, $T_A = 25^\circ\text{C}$, $C_L \leq 10\text{pF}$, pin 5 open circuit unless otherwise noted.

SYMBOL	PARAMETER	CONDITIONS	LT1190M/C			UNITS
			MIN	TYP	MAX	
V_{OS}	Input Offset Voltage			3.0	10.0	mV
I_{OS}	Input Offset Current			0.2	1.7	μA
I_B	Input Bias Current			± 0.5	± 2.5	μA
e_n	Input Noise Voltage	$f_0 = 10\text{kHz}$		50		$\text{nV}/\sqrt{\text{Hz}}$
i_n	Input Noise Current	$f_0 = 10\text{kHz}$		4.0		$\text{pA}/\sqrt{\text{Hz}}$
R_{IN}	Input Resistance	Differential Mode		130		$\text{k}\Omega$
		Common Mode		5.0		$\text{M}\Omega$
C_{IN}	Input Capacitance	$A_V = +1$		2.2		pF
	Input Voltage Range	(Note 2)	-2.5		+3.5	V
CMRR	Common Mode Rejection Ratio	$V_{CM} = -2.5V$ to $+3.5V$	60	70		dB
PSRR	Power Supply Rejection Ratio	$V_S = \pm 2.375V$ to $\pm 8.0V$	60	70		dB
A_{VOL}	Large Signal Voltage Gain	$R_L = 1\text{k}, V_0 = \pm 3.0V$	10	22		V/mV
		$R_L = 100\Omega, V_0 = \pm 3.0V$	2.5	6		
		$V_S = \pm 8V, R_L = 100\Omega, V_0 = \pm 5V$	3.5	12		
V_{OUT}	Output Voltage Swing	$V_S = \pm 5V, R_L = 1\text{k}$	± 3.7	± 4.0		V
		$V_S = \pm 8V, R_L = 1\text{k}$	± 6.7	± 7.0		
SR	Slew Rate	$A_V = -1, R_L = 1\text{k}$, (Note 3, 8)	325	450		$\text{V}/\mu\text{s}$
FPBW	Full Power Bandwidth	$V_0 = 6V_{p-p}$, (Note 4)	17.2	23.9		MHz
GBW	Gain Bandwidth Product			50		MHz
t_{r1}, t_{f1}	Rise Time, Fall Time	$A_V = +50, V_0 = \pm 1.5V$, 20% to 80%, (Note 8)	175	250	325	ns
t_{r2}, t_{f2}	Rise Time, Fall Time	$A_V = +1, V_0 = \pm 125\text{mV}$, 10% to 90%		1.9		ns
t_{PD}	Propagation Delay	$A_V = +1, V_0 = \pm 125\text{mV}$, 50% to 50%		2.4		ns
	Overshoot	$A_V = +1, V_0 = \pm 125\text{mV}$		5		%
t_s	Settling Time	3V Step, 0.1%, (Note 5)		140		ns
Diff A_V	Differential Gain	$R_L = 150\Omega, A_V = +2$, (Note 6)		0.35		%
Diff Ph	Differential Phase	$R_L = 150\Omega, A_V = +2$, (Note 6)		0.16		Deg. p-p

LT1190

ELECTRICAL CHARACTERISTICS $V_S = \pm 5V$, $T_A = 25^\circ C$, $C_L \leq 10pF$, pin 5 open circuit unless otherwise noted.

SYMBOL	PARAMETER	CONDITIONS	LT1190M/C			UNITS
			MIN	TYP	MAX	
I_S	Supply Current			32	38	mA
	Shutdown Supply Current	Pin 5 at V^-		1.3	2.0	mA
$I_{S/D}$	Shutdown Pin Current	Pin 5 at V^-		20	50	μA
t_{on}	Turn On Time	Pin 5 from V^- to Ground, $R_L = 1k$		100		ns
t_{off}	Turn Off Time	Pin 5 from Ground to V^- , $R_L = 1k$		400		ns

ELECTRICAL CHARACTERISTICS

$V_{S+} = +5V$, $V_{S-} = 0V$, $V_{CM} = +2.5V$, $T_A = 25^\circ C$, $C_L \leq 10pF$, pin 5 open circuit unless otherwise noted.

SYMBOL	PARAMETER	CONDITIONS	LT1190M/C			UNITS
			MIN	TYP	MAX	
V_{OS}	Input Offset Voltage			3.0	11.0	mV
I_{OS}	Input Offset Current			0.2	1.2	μA
I_B	Input Bias Current			± 0.5	± 1.5	μA
	Input Voltage Range	(Note 2)	+2.0		+3.5	V
CMRR	Common Mode Rejection Ratio	$V_{CM} = +2.0V$ to $+3.5V$	55	70		dB
A_{VOL}	Large Signal Voltage Gain	$R_L = 100\Omega$ to Ground	85	70		dB

ELECTRICAL CHARACTERISTICS $V_S = \pm 5V, 0^\circ C \leq T_A \leq 70^\circ C$, pin 5 open circuit unless otherwise noted.

SYMBOL	PARAMETER	CONDITIONS	LT1190C			UNITS
			MIN	TYP	MAX	
V_{OS}	Input Offset Voltage		●	3.0	11.0	mV
$\Delta V_{OS}/\Delta T$	Input V_{OS} Drift		●	16		$\mu V/^\circ C$
I_{OS}	Input Offset Current		●	0.2	1.7	μA
I_B	Input Bias Current		●	± 0.5	± 2.5	μA
CMRR	Common Mode Rejection Ratio	$V_{CM} = -2.5V$ to $+3.5V$	●	58	70	dB
PSRR	Power Supply Rejection Ratio	$V_S = \pm 2.375V$ to $\pm 5.0V$	●	58	70	dB
A_{VOL}	Large Signal Voltage Gain	$R_L = 1k, V_O = \pm 3.0V$	●	9	20	V/mV
		$R_L = 100\Omega, V_O = \pm 3.0V$	●	2.0	6.0	
V_{OUT}	Output Voltage Swing	$R_L = 1k$	●	± 3.70	± 3.9	V
I_S	Supply Current		●	32	38	mA
	Shutdown Supply Current	Pin 5 at V^- , (Note 7)	●	1.4	2.1	mA
$I_{S/D}$	Shutdown Pin Current	Pin 5 at V^-	●	20		μA

The ● denotes the specifications which apply over the full operating temperature range.

Note 1: A heat sink is required to keep the junction temperature below absolute maximum when the output is shorted.

Note 2: Exceeding the input common mode range may cause the output to invert.

Note 3: Slew rate is measured between $\pm 1V$ on the output, with a $\pm 3V$ input step.

Note 4: Full power bandwidth is calculated from the slew rate measurement: $FPBW = SR/2\pi V_p$.

Note 5: Settling time measurement techniques are shown in "Take the Guesswork Out of Settling Time Measurements," EDN, September 19, 1985. $A_V = -1, R_L = 1k$.

Note 6: NTSC (3.58MHz). For $R_L = 1k, \text{Diff } A_V = 0.1\%, \text{Diff Ph} = 0.06^\circ$.

Note 7: See Applications section for shutdown at elevated temperatures. Do not operate the shutdown above $T_J > 125^\circ C$.

Note 8: AC parameters are 100% tested on the ceramic and plastic DIP packaged parts (J and N suffix) and are sample tested on every lot of the SO packaged parts (S suffix).

2

Optional Offset Nulling Circuit

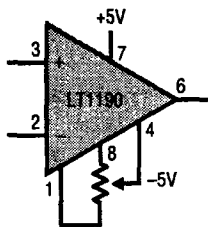

INPUT OFFSET VOLTAGE CAN BE ADJUSTED OVER A $\pm 150mV$ RANGE WITH A $1k\Omega$ TO $10k\Omega$ POTENTIOMETER.

LT1190-TAQ3

TYPICAL PERFORMANCE CHARACTERISTICS

Input Bias Current vs Common Mode Voltage

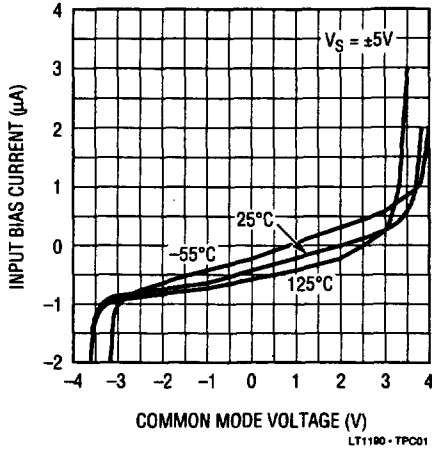

Input Bias Current vs Temperature

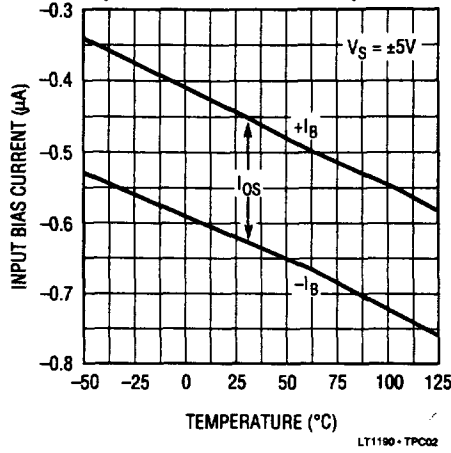

Common Mode Voltage vs Supply Voltage

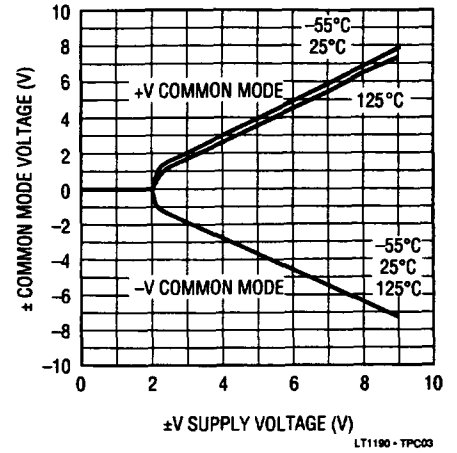

Equivalent Input Noise Voltage vs Frequency

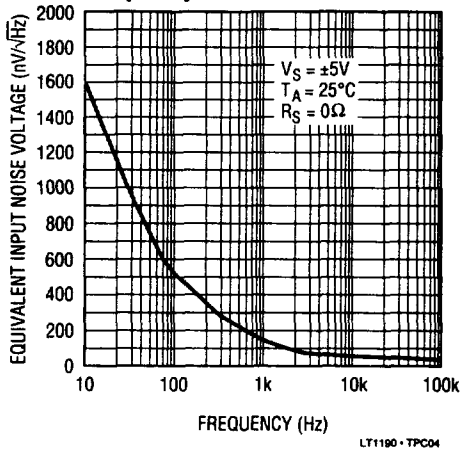

Equivalent Input Noise Current vs Frequency

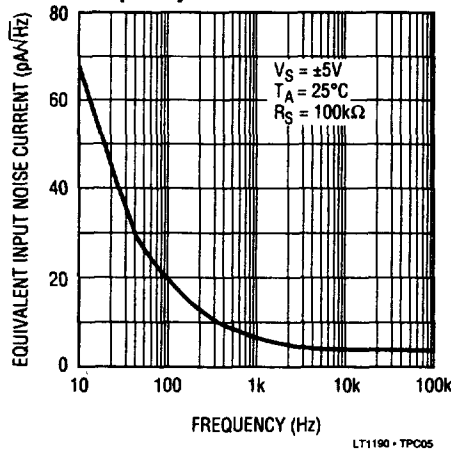

Supply Current vs Supply Voltage

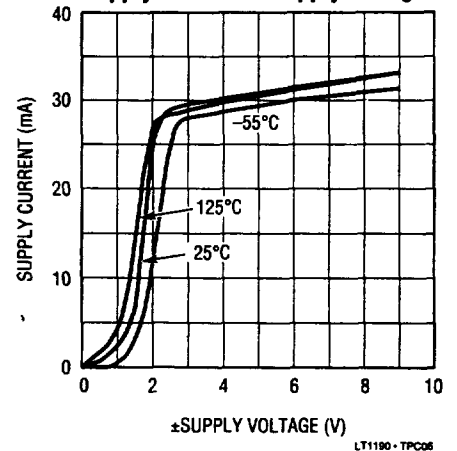

Shutdown Supply Current vs Temperature

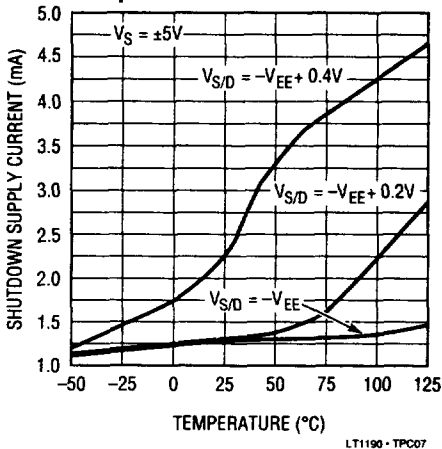

Open Loop Voltage Gain vs Temperature

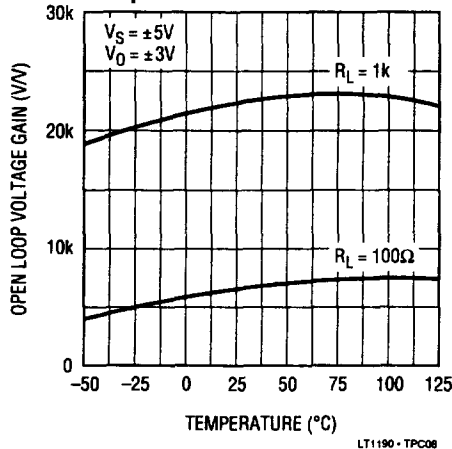

Open Loop Voltage Gain vs Load Resistance

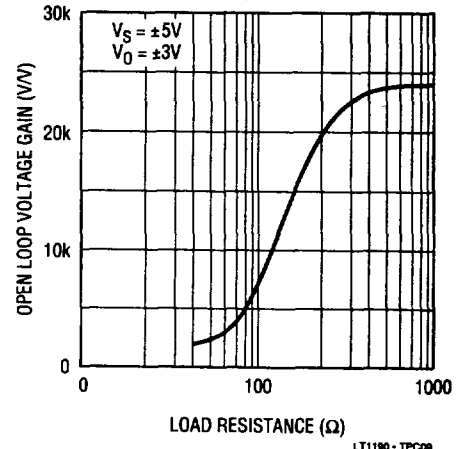

TYPICAL PERFORMANCE CHARACTERISTICS

Gain, Phase vs Frequency

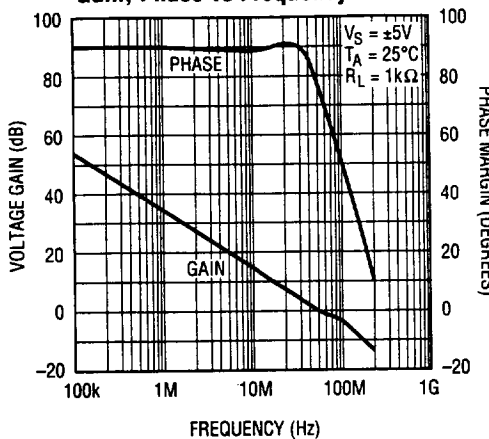

LT1190 - TPC10

Gain Bandwidth Product vs Supply Voltage

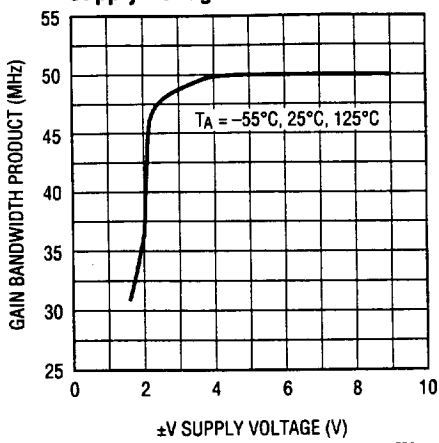

LT1190 - TPC11

Output Impedance vs Frequency

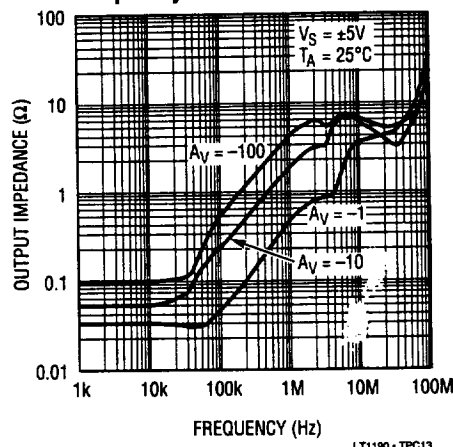

LT1190 - TPC13

2

Unity Gain Frequency and Phase Margin vs Temperature

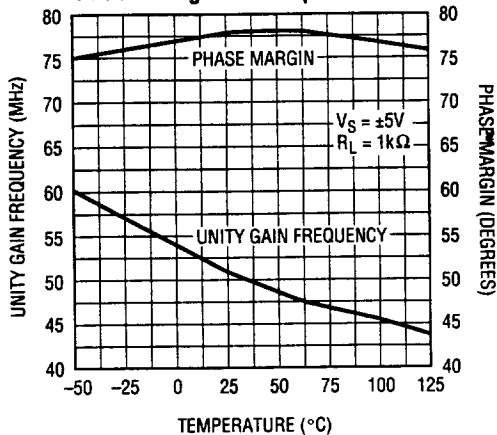

LT1190 - TPC12

Common Mode Rejection Ratio vs Frequency

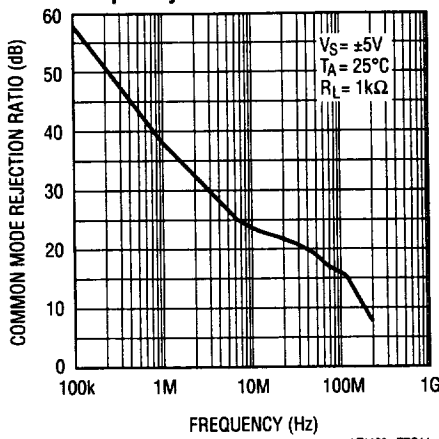

LT1190 - TPC14

Power Supply Rejection Ratio vs Frequency

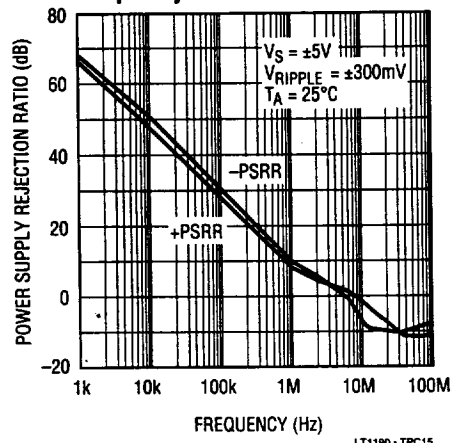

LT1190 - TPC15

Output Short Circuit Current vs Temperature

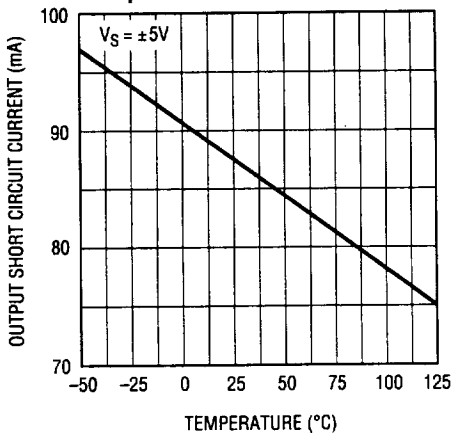

LT1190 - TPC16

± Output Swing vs Supply Voltage

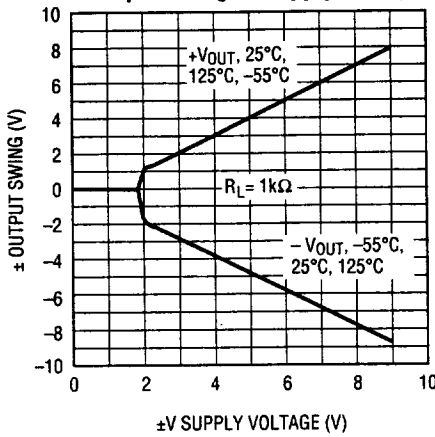

LT1190 - TPC17

Output Voltage Swing vs Load Resistance

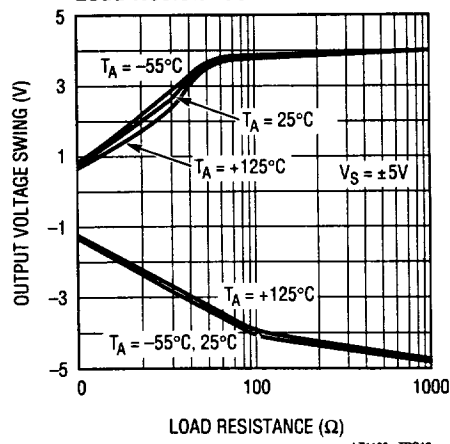

LT1190 - TPC18

TYPICAL PERFORMANCE CHARACTERISTICS

Slew Rate vs Temperature

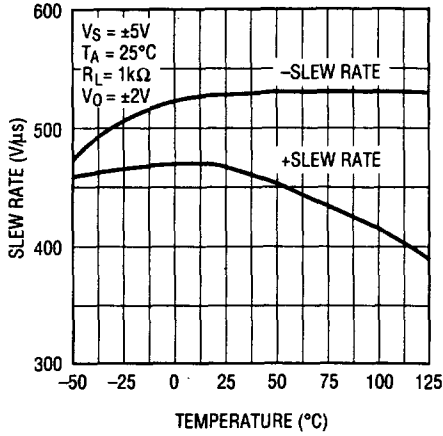

Output Voltage Step vs Settling Time, $A_V = -1$

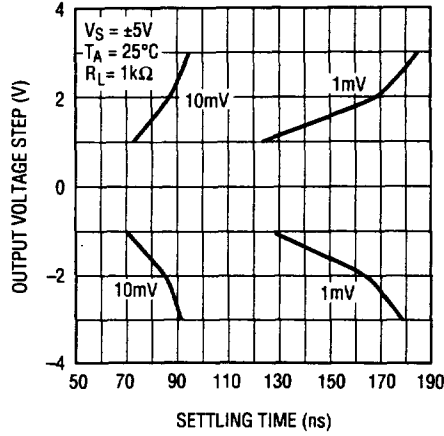

Output Voltage Step vs Settling Time, $A_V = +1$

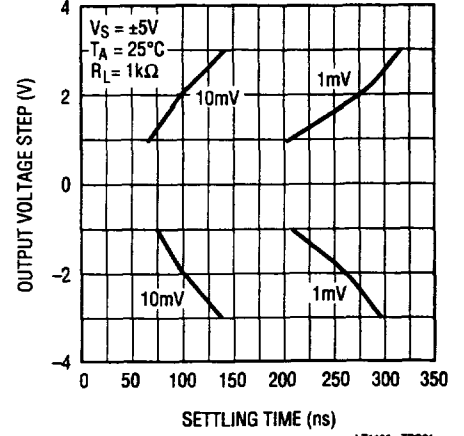

Large Signal Transient Response

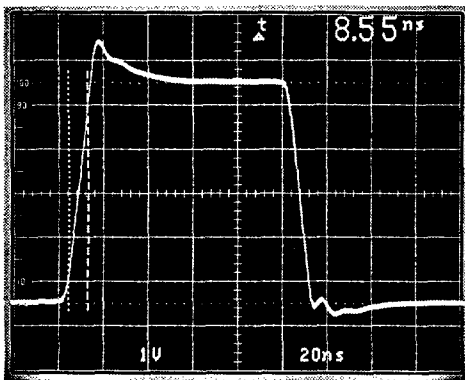

$A_V = +1, C_L = 10\text{pF}$ SCOPE PROBE
LT1190 - TPC22

Output Overload

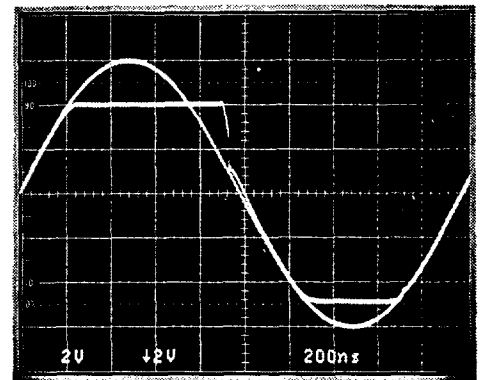

$A_V = -1, V_{IN} = 12\text{Vp-p}$
LT1190 - TPC23

Small Signal Transient Response

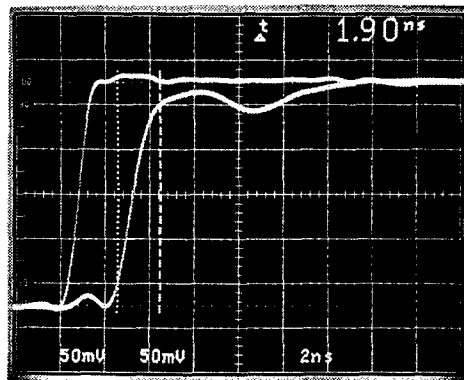

$A_V = +1$, SMALL SIGNAL RISE TIME, WITH FET PROBES
LT1190 - TPC24

APPLICATIONS INFORMATION

Power Supply Bypassing

The LT1190 is quite tolerant of power supply bypassing. In some applications a 0.1 μ F ceramic disc capacitor placed 1/2 inch from the amplifier is all that is required. A scope photo of the amplifier output with no supply bypassing is used to demonstrate this bypassing tolerance, $R_L = 1k\Omega$.

No Supply Bypass Capacitors

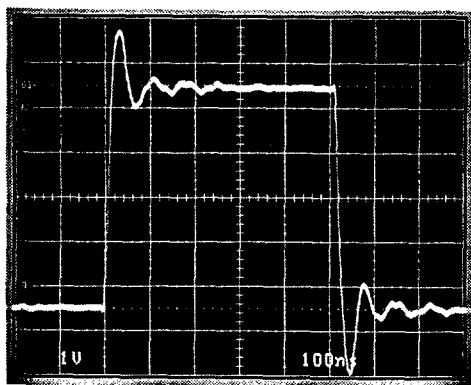

$A_V = -1$, IN DEMO BOARD, $R_L = 1k\Omega$

LT1190 - TA04

Supply bypassing can also affect the response in the frequency domain. It is possible to see a slight 1dB rise in the frequency response at 130MHz depending on the gain configuration, supply bypass, inductance in the supply leads, and printed circuit board layout. This can be further minimized by not using a socket.

Closed Loop Voltage Gain vs Frequency

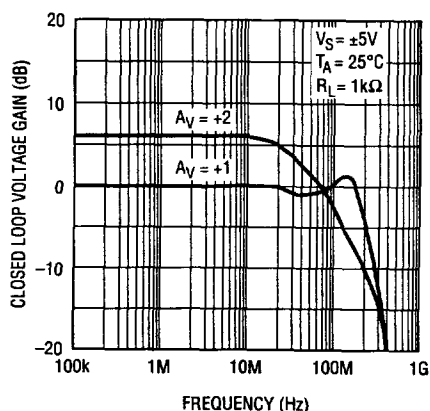

LT1190 - TA05

In most applications, and those requiring good settling time, it is important to use multiple bypass capacitors. A 0.1 μ F ceramic disc in parallel with a 4.7 μ F tantalum is recommended. Two oscilloscope photos with different bypass conditions are used to illustrate the settling time characteristics of the amplifier. Note that although the output waveform looks acceptable at 1V/div, when amplified to 1mV/div the settling time to 2mV is 4.244 μ s for the 0.1 μ F bypass; the time drops to 163ns with multiple bypass capacitors.

Settling Time Poor Bypass

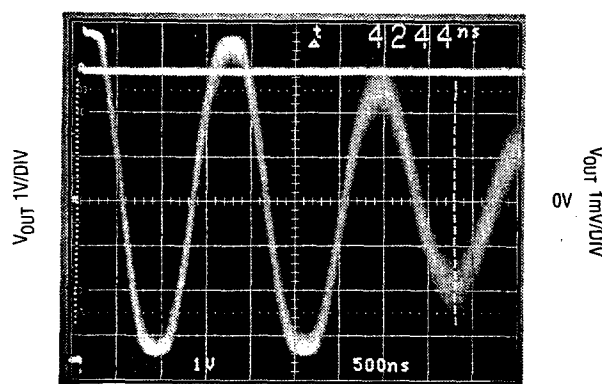

SETTLING TIME TO 2mV, $A_V = -1$
SUPPLY BYPASS CAPACITORS = 0.1 μ F

LT1190 - TA06

Settling Time Good Bypass

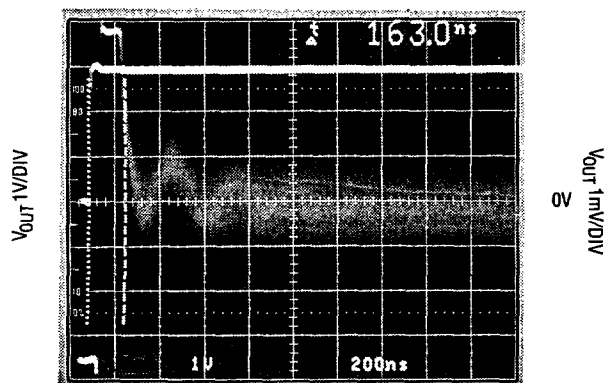

SETTLING TIME TO 2mV, $A_V = -1$
SUPPLY BYPASS CAPACITORS = 0.1 μ F + 4.7 μ F TANTALUM

LT1190 - TA07

2

APPLICATIONS INFORMATION

Cable Terminations

The LT1190 operational amplifier has been optimized as a low cost video cable driver. The $\pm 50\text{mA}$ guaranteed output current enables the LT1190 to easily deliver 7.5Vp-p into 100Ω , while operating on $\pm 5\text{V}$ supplies, or 2.6Vp-p on a single 5V supply.

Double Terminated Cable Driver

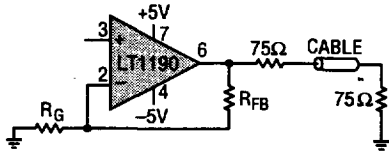

Cable Driver Voltage Gain vs Frequency

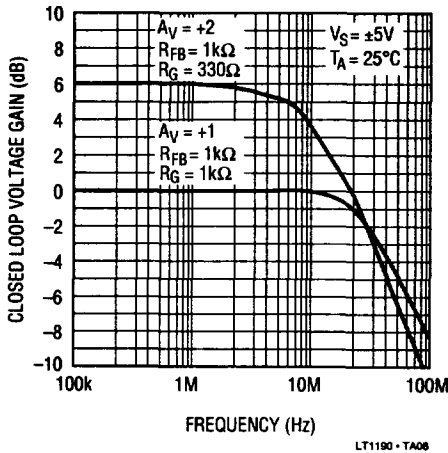

When driving a cable it is important to terminate the cable to avoid unwanted reflections. This can be done in one of two ways: single termination or double termination. With single termination, the cable must be terminated at the receiving end (75Ω to ground) to absorb unwanted energy. The best performance can be obtained by double termination (75Ω in series with the output of the amplifier, and 75Ω to ground at the other end of the cable). This termination is preferred because reflected energy is absorbed at each end of the cable. When using the double termination technique it is important to note that the signal is attenuated by a factor of 2, or 6dB . This can be compensated for by taking a gain of 2, or 6dB in the amplifier. The cable driver has a -3dB bandwidth in excess of 30MHz while driving the 150Ω load.

Using the Shutdown Feature

The LT1190 has a unique feature that allows the amplifier to be shutdown for conserving power, or for multiplexing several amplifiers onto a common cable. The amplifier will shutdown by taking pin 5 to V^- . In shutdown, the amplifier dissipates 15mW while maintaining a true high impedance output state of $15\text{k}\Omega$ in parallel with the feedback resistors. The amplifiers must be used in a non-inverting configuration for MUX applications. In inverting configurations the input signal is fed to the output through the feedback components. The following scope photos show that with very high R_L , the output is truly high impedance; the output slowly decays toward ground. Additionally, when the output is loaded with as little as $1\text{k}\Omega$ the amplifier shuts off in 400ns . This shutoff can be under the control of HC CMOS operating between 0V and -5V .

Output Shutdown

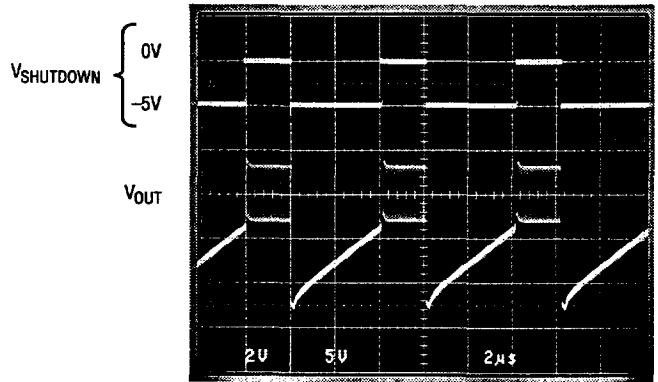

1MHz SINE WAVE GATED OFF WITH SHUTDOWN PIN, $A_V = +1$, $R_L = \text{SCOPE PROBE}$

LT1190 - TA09

Output Shutdown

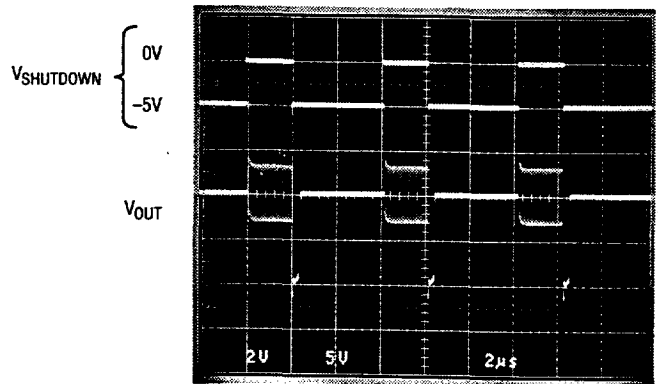

1MHz SINE WAVE GATED OFF WITH SHUTDOWN PIN, $A_V = +1$, $R_L = 1\text{k}\Omega$

LT1190 - TA10

APPLICATIONS INFORMATION

The ability to maintain shutoff is shown on the curve Shutdown Supply Current vs Temperature in the Typical Performance Characteristics section. At very high elevated temperatures it is important to hold the shutdown pin close to the negative supply to keep the supply current from increasing.

Murphy Circuits

There are several precautions the user should take when using the LT1190 in order to realize its full capability. Although the LT1190 can drive a 50pF load, isolating the capacitance with 10 Ω can be helpful. Precautions primarily have to do with driving large capacitive loads.

Other precautions include:

1. Use a ground plane (see Design Note 50, High Frequency Amplifier Evaluation Board).
2. Do not use high source impedances. The input capacitance of 2pF, and $R_S = 10\text{k}\Omega$ for instance, will give an 8MHz – 3dB bandwidth.
3. PC board socket may reduce stability.
4. A feedback resistor of 1k Ω or lower reduces the effects of stray capacitance at the inverting input. (For instance, closed loop gain of +2 can use $R_{FB} = 300\Omega$ and $R_G = 300\Omega$.)

2

Driving Capacitive Load

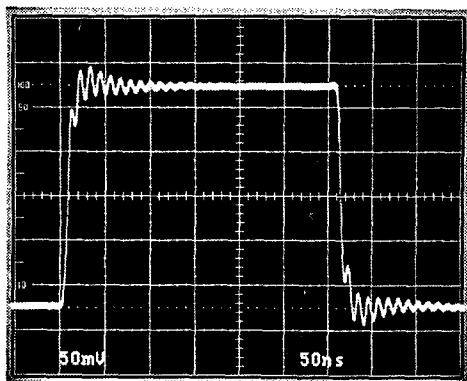

$A_V = -1$, IN DEMO BOARD, $C_L = 50\text{pF}$

LT1190 - TA11

Driving Capacitive Load

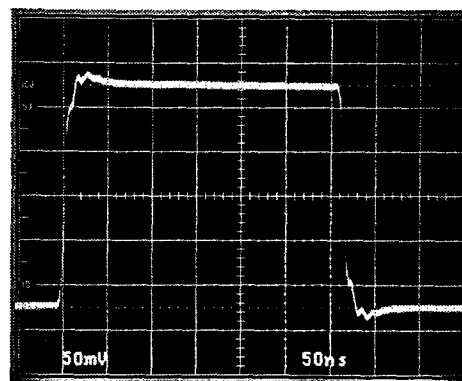

$A_V = -1$, IN DEMO BOARD, $C_L = 50\text{pF}$ WITH
10 Ω ISOLATING RESISTOR

LT1190 - TA12

Murphy Circuits

SIMPLIFIED SCHEMATIC

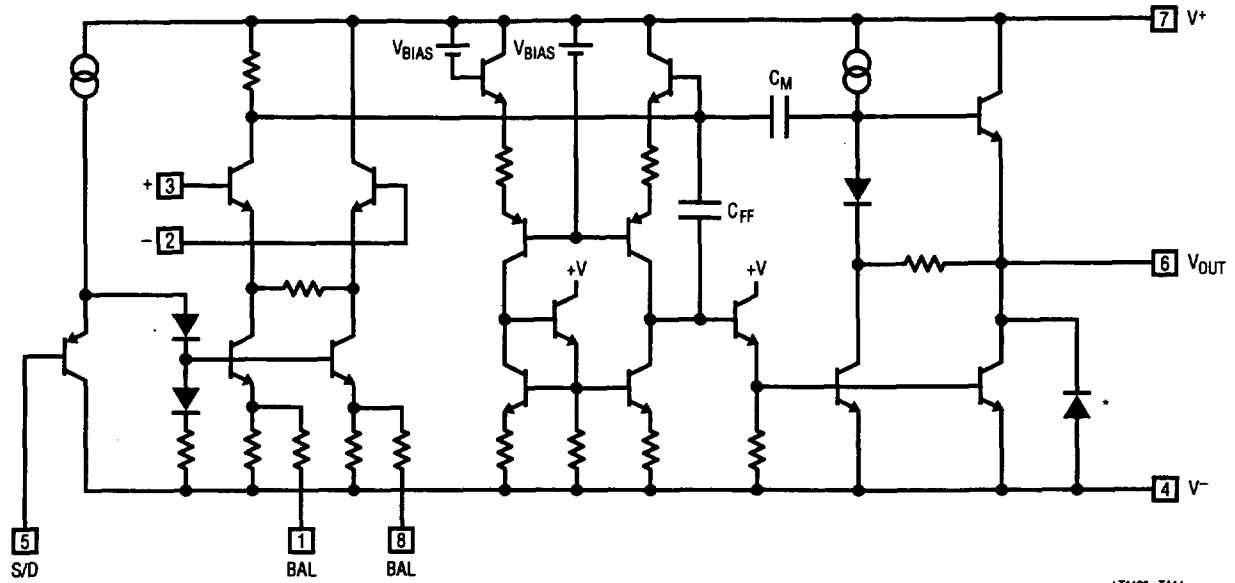

* SUBSTRATE DIODE, DO NOT FORWARD BIAS

LT1190-TA14