

Dual and Quad Micropower Rail-to-Rail Input and Output Op Amps

FEATURES

- Rail-to-Rail Input and Output
- Single Supply Input Range: **-0.4V to 44V**
- Micropower: **50µA/Amplifier Max**
- Specified on 3V, 5V and ±15V Supplies
- High Output Current: 20mA
- Output Drives 10,000pF with Output Compensation
- Reverse Battery Protection to 18V
- No Supply Sequencing Problems
- High Voltage Gain: 1500V/mV
- High CMRR: 98dB
- No Phase Reversal
- Gain Bandwidth Product: 200kHz

APPLICATIONS

- Battery- or Solar-Powered Systems
 - Portable Instrumentation
 - Sensor Conditioning
- Supply Current Sensing
- Battery Monitoring
- Micropower Active Filters
- 4mA to 20mA Transmitters

DESCRIPTION

The dual LT[®]1490 and quad LT1491 op amps operate on all single and split supplies with a total voltage of 2V to 44V drawing only 40µA of quiescent current per amplifier. These amplifiers are reverse supply protected; they draw no current for reverse supply up to 18V. The input range of the LT1490/LT1491 includes both supplies and the output swings to both supplies. Unlike most micropower op amps, the LT1490/LT1491 can drive heavy loads; their rail-to-rail outputs drive 20mA. The LT1490/LT1491 are unity-gain stable and drive all capacitive loads up to 10,000pF when optional 0.22µF and 150Ω compensation is used.

The LT1490/LT1491 have a unique input stage that operates and remains high impedance when above the positive supply. The inputs take 44V both differential and common mode even when operating on a 3V supply. Built-in resistors protect the inputs for faults below the negative supply up to 22V. There is no phase reversal of the output for inputs 22V below V⁻ or 44V above V⁻, independent of V⁺.

The LT1490 dual op amp is available in the 8-pin SO and PDIP packages. The quad LT1491 is available in the 14-pin SO and PDIP packages.

LT, LTC and LT are registered trademarks of Linear Technology Corporation.

TYPICAL APPLICATION

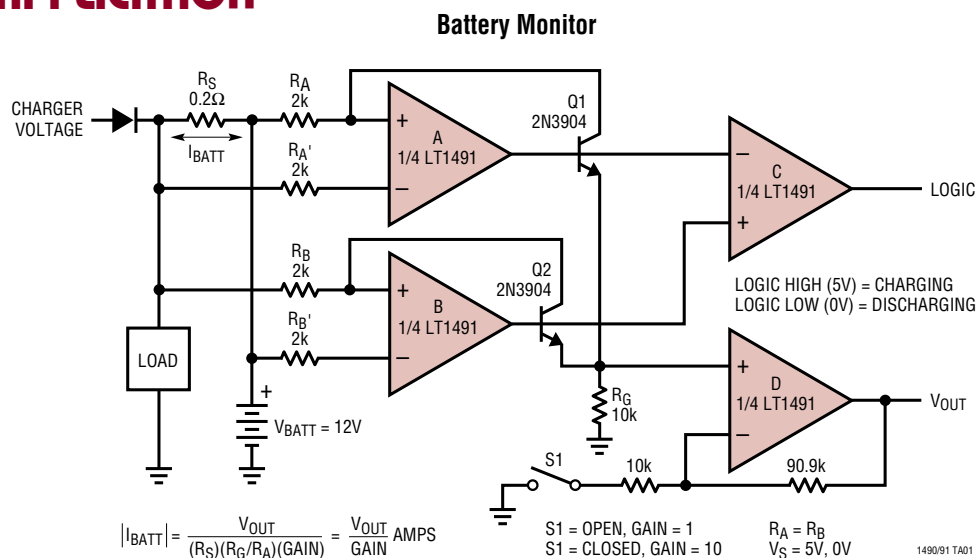

ABSOLUTE MAXIMUM RATINGS

Total Supply Voltage (V^+ to V^-)	44V	Junction Temperature	150°C
Input Differential Voltage	44V	Specified Temperature Range (Note 2) ..	-40°C to 85°C
Input Current	±25mA	Storage Temperature Range	-65°C to 150°C
Output Short-Circuit Duration (Note 1)	Continuous	Lead Temperature (Soldering, 10 sec)	300°C
Operating Temperature Range	-40°C to 85°C		

PACKAGE/ORDER INFORMATION

<p>MS8 PACKAGE 8-LEAD MSOP N8 PACKAGE 8-LEAD PDIP S8 PACKAGE 8-LEAD PLASTIC SO</p> <p>$T_{JMAX} = 150^{\circ}\text{C}$, $\theta_{JA} = 250^{\circ}\text{C/W}$ (MS8) $T_{JMAX} = 150^{\circ}\text{C}$, $\theta_{JA} = 130^{\circ}\text{C/W}$ (N8) $T_{JMAX} = 150^{\circ}\text{C}$, $\theta_{JA} = 190^{\circ}\text{C/W}$ (S8)</p>	ORDER PART NUMBER	<p>N PACKAGE 14-LEAD PDIP S PACKAGE 14-LEAD PLASTIC SO</p> <p>$T_{JMAX} = 150^{\circ}\text{C}$, $\theta_{JA} = 110^{\circ}\text{C/W}$ (N) $T_{JMAX} = 150^{\circ}\text{C}$, $\theta_{JA} = 150^{\circ}\text{C/W}$ (S)</p>	ORDER PART NUMBER
	LT1490CMS8 LT1490CN8 LT1490CS8		LT1491CN LT1491CS
	MS8 PART MARKING		
	LTBB		
	S8 PART MARKING		
	1490		

Consult factory for Industrial and Military grade parts.

ELECTRICAL CHARACTERISTICS

$V_S = 3V, 0V$; $V_S = 5V, 0V$; $V_{CM} = V_{OUT} = \text{half supply}$, $T_A = 25^{\circ}\text{C}$, unless otherwise noted. (Note 2)

SYMBOL	PARAMETER	CONDITIONS	MIN	TYP	MAX	UNITS
V_{OS}	Input Offset Voltage	LT1490 N Package $0^{\circ}\text{C} \leq T_A \leq 70^{\circ}\text{C}$ $-40^{\circ}\text{C} \leq T_A \leq 85^{\circ}\text{C}$	●	220	800	μV
			●		1000	μV
			●		1100	μV
		LT1490 S Package $0^{\circ}\text{C} \leq T_A \leq 70^{\circ}\text{C}$ $-40^{\circ}\text{C} \leq T_A \leq 85^{\circ}\text{C}$	●	220	950	μV
		●		1200	μV	
		●		1300	μV	
	Input Offset Voltage Drift	LT1491 N Package $0^{\circ}\text{C} \leq T_A \leq 70^{\circ}\text{C}$ $-40^{\circ}\text{C} \leq T_A \leq 85^{\circ}\text{C}$	●	300	1100	μV
			●		1350	μV
			●		1450	μV
		LT1490CMS8 Package, LT1491 S Package $0^{\circ}\text{C} \leq T_A \leq 70^{\circ}\text{C}$ $-40^{\circ}\text{C} \leq T_A \leq 85^{\circ}\text{C}$	●	350	1450	μV
		●		1650	μV	
		●		1750	μV	
	Input Offset Voltage Drift	$0^{\circ}\text{C} \leq T_A \leq 70^{\circ}\text{C}$ (Note 6)	●	2	4	$\mu\text{V}/^{\circ}\text{C}$
I_{OS}	Input Offset Current	$V_{CM} = 44V$ (Note 3)	●	0.2	0.8	nA
			●		0.8	μA
I_B	Input Bias Current	$V_{CM} = 44V$ (Note 3)	●	4	8	nA
		$V_S = 0V$	●	4	10	μA
			●	0.1		nA
	Input Noise Voltage	0.1Hz to 10Hz		1		μV_{P-P}
e_n	Input Noise Voltage Density	$f = 1\text{kHz}$		50		$\text{nV}/\sqrt{\text{Hz}}$
i_n	Input Noise Current Density	$f = 1\text{kHz}$		0.03		$\text{pA}/\sqrt{\text{Hz}}$

ELECTRICAL CHARACTERISTICS

$V_S = 3V, 0V; V_S = 5V, 0V; V_{CM} = V_{OUT} = \text{half supply}, T_A = 25^\circ C$, unless otherwise noted. (Note 2)

SYMBOL	PARAMETER	CONDITIONS	MIN	TYP	MAX	UNITS	
R_{IN}	Input Resistance	Differential	6	17		$M\Omega$	
		Common Mode, $V_{CM} = 0V$ to $44V$	4	11		$M\Omega$	
C_{IN}	Input Capacitance			4.6		pF	
	Input Voltage Range	●	0		44	V	
CMRR	Common Mode Rejection Ratio (Note 3)	$V_{CM} = 0V$ to $V_{CC} - 1V$	●	84	98	dB	
		$V_{CM} = 0V$ to $44V$	●	80	98	dB	
A_{VOL}	Large-Signal Voltage Gain	$V_S = 3V, V_O = 500mV$ to $2.5V, R_L = 10k$	●	200	1500	V/mV	
		$0^\circ C \leq T_A \leq 70^\circ C$	●	133		V/mV	
		$-40^\circ C \leq T_A \leq 85^\circ C$	●	100		V/mV	
		$V_S = 5V, V_O = 500mV$ to $4.5V, R_L = 10k$	●	400	1500	V/mV	
V_{OL}	Output Voltage Swing Low	$V_S = 3V, \text{No Load}$	●		22	50	mV
		$V_S = 3V, I_{SINK} = 5mA$	●		250	450	mV
		$V_S = 5V, \text{No Load}$	●		22	50	mV
		$V_S = 5V, I_{SINK} = 5mA$	●		250	500	mV
V_{OH}	Output Voltage Swing High	$V_S = 3V, \text{No Load}$	●	2.95	2.978	V	
		$V_S = 3V, I_{SOURCE} = 5mA$	●	2.55	2.6	V	
		$V_S = 5V, \text{No Load}$	●	4.95	4.978	V	
		$V_S = 5V, I_{SOURCE} = 10mA$	●	4.30	4.6	V	
I_{SC}	Short-Circuit Current (Note 1)	$V_S = 3V, \text{Short to GND}$		10	15	mA	
		$V_S = 3V, \text{Short to } V_{CC}$		10	30	mA	
		$V_S = 5V, \text{Short to GND}$		15	25	mA	
		$V_S = 5V, \text{Short to } V_{CC}$		15	30	mA	
PSRR	Power Supply Rejection Ratio	$V_S = 2.5V$ to $12.5V, V_{CM} = V_O = 1V$	●	84	98	dB	
	Minimum Operating Supply Voltage		●	2	2.5	V	
	Reverse Supply Voltage	$I_S = -100\mu A$ per Amplifier	●	18	27	V	
I_S	Supply Current per Amplifier (Note 4)		●	40	50	μA	
			●		55	μA	
GBW	Gain Bandwidth Product (Note 3)	$f = 1kHz$	●	110	180	kHz	
		$0^\circ C \leq T_A \leq 70^\circ C$	●	100		kHz	
		$-40^\circ C \leq T_A \leq 85^\circ C$	●	90		kHz	
SR	Slew Rate (Note 5)	$A_V = -1, R_L = \infty$	●	0.035	0.06	V/ μs	
		$0^\circ C \leq T_A \leq 70^\circ C$	●	0.031		V/ μs	
		$-40^\circ C \leq T_A \leq 85^\circ C$	●	0.030		V/ μs	

$V_S = \pm 15V, V_{CM} = 0V, V_{OUT} = 0V, T_A = 25^\circ C$, unless otherwise noted. (Note 2)

SYMBOL	PARAMETER	CONDITIONS	MIN	TYP	MAX	UNITS	
V_{OS}	Input Offset Voltage	LT1490 N, S Package	●		250	1200	μV
		$0^\circ C \leq T_A \leq 70^\circ C$	●			1400	μV
		$-40^\circ C \leq T_A \leq 85^\circ C$	●			1500	μV
		LT1491 N Package	●		350	1250	μV
		$0^\circ C \leq T_A \leq 70^\circ C$	●			1500	μV
		$-40^\circ C \leq T_A \leq 85^\circ C$	●			1600	μV
		LT1490CMS8 Package, LT1491 S Package	●		400	1600	μV
		$0^\circ C \leq T_A \leq 70^\circ C$	●			1850	μV
		$-40^\circ C \leq T_A \leq 85^\circ C$	●			1950	μV

ELECTRICAL CHARACTERISTICS

$V_S = \pm 15V$, $V_{CM} = 0V$, $V_{OUT} = 0V$, $T_A = 25^\circ C$, unless otherwise noted. (Note 2)

SYMBOL	PARAMETER	CONDITIONS	MIN	TYP	MAX	UNITS
	Input Offset Voltage Drift	$0^\circ C \leq T_A \leq 70^\circ C$ (Note 6)	●	3	6	$\mu V/^\circ C$
I_{OS}	Input Offset Current		●	0.2	0.8	nA
I_B	Input Bias Current		●	4	8	nA
	Input Noise Voltage	0.1Hz to 10Hz		1		μV_{P-P}
e_n	Input Noise Voltage Density	$f = 1kHz$		50		nV/\sqrt{Hz}
i_n	Input Noise Current Density	$f = 1kHz$		0.03		pA/\sqrt{Hz}
R_{IN}	Input Resistance	Differential Common Mode, $V_{CM} = -15V$ to $14V$		6 17 15000		$M\Omega$ $M\Omega$
C_{IN}	Input Capacitance			4.6		pF
	Input Voltage Range		●	-15	29	V
CMRR	Common Mode Rejection Ratio	$V_{CM} = -15V$ to $29V$	●	80	98	dB
A_{VOL}	Large-Signal Voltage Gain	$V_O = \pm 14V$, $R_L = 10k$ $0^\circ C \leq T_A \leq 70^\circ C$ $-40^\circ C \leq T_A \leq 85^\circ C$	● ● ●	100 75 50	250	V/mV V/mV V/mV
V_O	Output Voltage Swing	No Load $I_{OUT} = \pm 5mA$ $I_{OUT} = \pm 10mA$	● ● ●	± 14.9 ± 14.5 ± 14.5	± 14.978 ± 14.750 ± 14.670	V V V
I_{SC}	Short-Circuit Current (Note 1)	Short to GND $0^\circ C \leq T_A \leq 70^\circ C$ $-40^\circ C \leq T_A \leq 85^\circ C$	● ●	± 20 ± 15 ± 10	± 25	mA mA mA
PSRR	Power Supply Rejection Ratio	$V_S = \pm 1.25V$ to $\pm 22V$	●	88	98	dB
I_S	Supply Current per Amplifier		●	50	70 85	μA μA
GBW	Gain Bandwidth Product	$f = 1kHz$ $0^\circ C \leq T_A \leq 70^\circ C$ $-40^\circ C \leq T_A \leq 85^\circ C$	● ●	125 110 100	200	kHz kHz kHz
SR	Slew Rate	$A_V = -1$, $R_L = \infty$, $V_O = \pm 10V$, Measure at $V_O = \pm 5V$ $0^\circ C \leq T_A \leq 70^\circ C$ $-40^\circ C \leq T_A \leq 85^\circ C$	● ●	0.0375 0.0330 0.0300	0.07	$V/\mu s$ $V/\mu s$ $V/\mu s$

The ● denotes specifications which apply over the full operating temperature range.

Note 1: A heat sink may be required to keep the junction temperature below absolute maximum. This depends on the power supply voltage and how many amplifiers are shorted.

Note 2: The LT1490/LT1491 are designed, characterized and expected to meet these extended temperature limits, but are not tested at $-40^\circ C$ and $85^\circ C$. Guaranteed I grade parts are available, consult factory.

Note 3: $V_S = 5V$ limits are guaranteed by correlation to $V_S = 3V$ and $V_S = \pm 15V$ tests.

Note 4: $V_S = 3V$ limits are guaranteed by correlation to $V_S = 5V$ and $V_S = \pm 15V$ tests.

Note 5: Guaranteed by correlation to slew rate at $V_S = \pm 15V$ and GBW at $V_S = 3V$ and $V_S = \pm 15V$ tests.

Note 6: This parameter is not 100% tested.

TYPICAL PERFORMANCE CHARACTERISTICS

Supply Current vs Supply Voltage

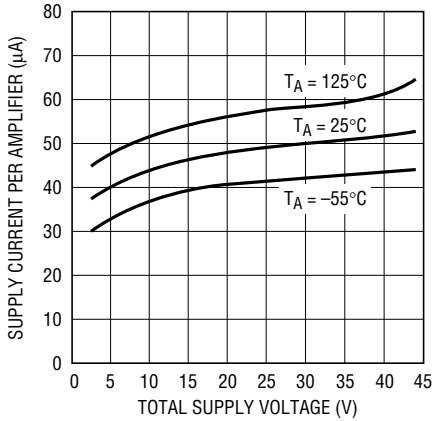

1490/91 G01

Minimum Supply Voltage

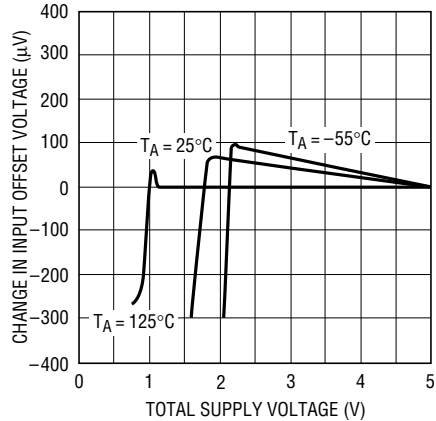

1490/91 G02

Input Bias Current vs Common Mode Voltage

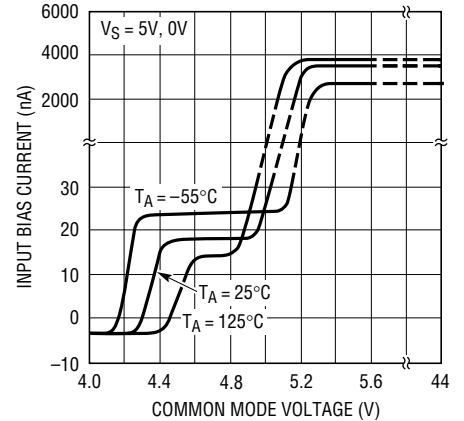

1490/91 G03

Output Saturation Voltage vs Load Current (Output High)

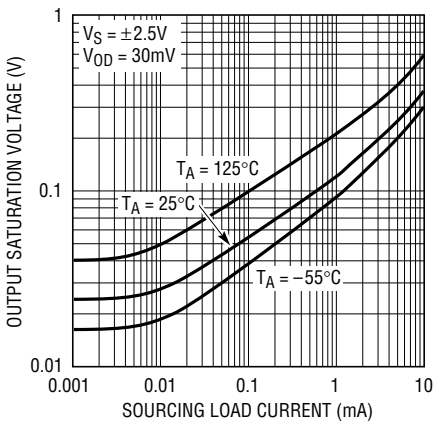

1490/90 G04

Output Saturation Voltage vs Load Current (Output Low)

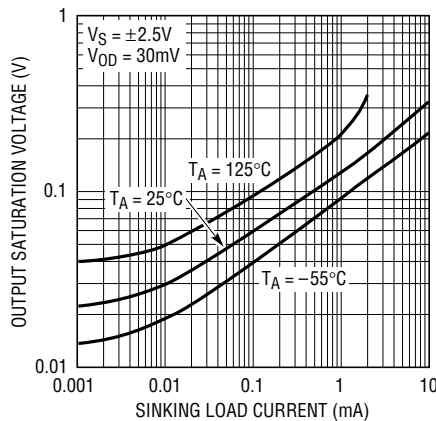

1490/90 G05

Output Saturation Voltage vs Input Overdrive

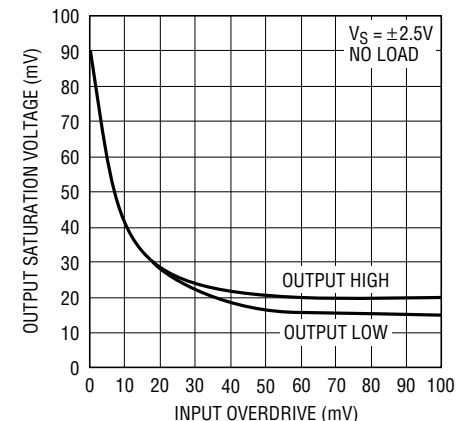

1490/91 G06

0.1Hz to 10Hz Noise Voltage

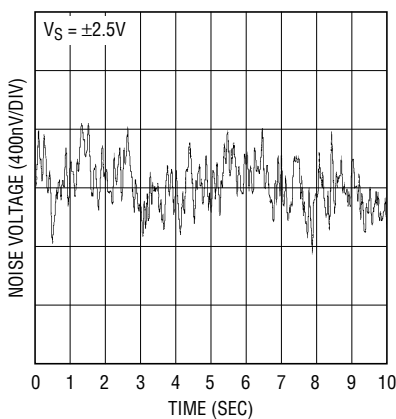

1490 G07

Noise Voltage Density vs Frequency

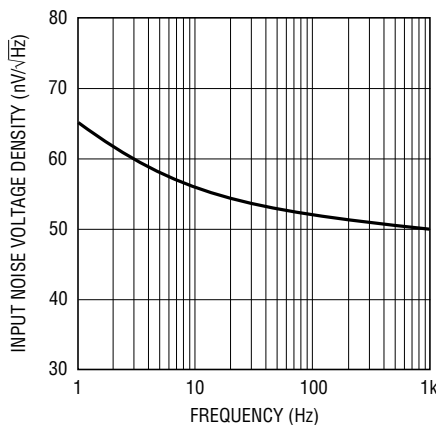

1490/91 G08

Input Noise Current vs Frequency

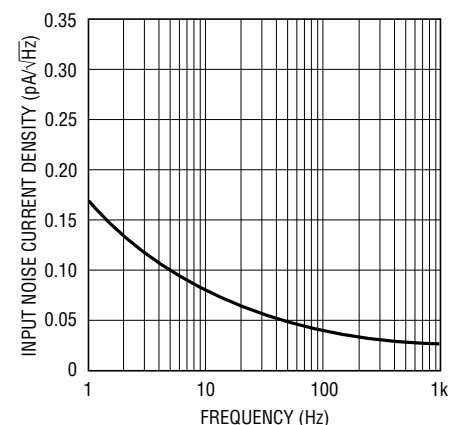

1490/91 G09

TYPICAL PERFORMANCE CHARACTERISTICS

Gain and Phase Shift vs Frequency

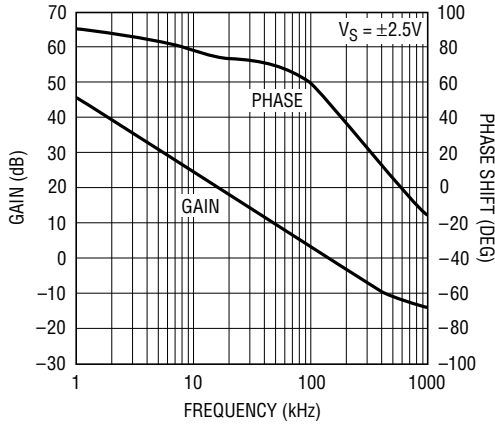

1490/91 G10

Gain Bandwidth Product vs Temperature

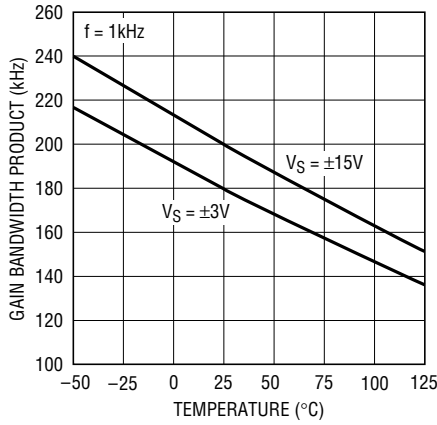

1490/91 G11

Slew Rate vs Temperature

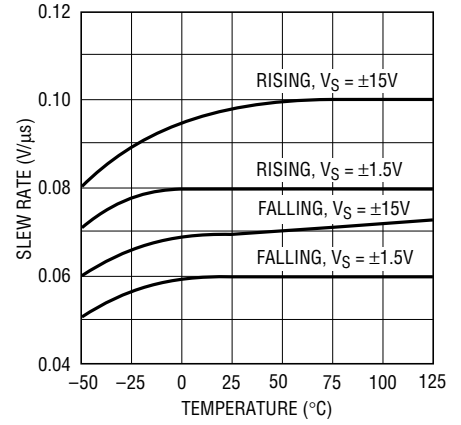

1490/91 G12

Gain Bandwidth Product and Phase Margin vs Supply Voltage

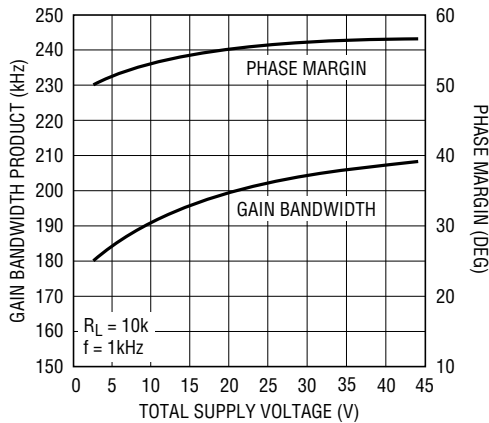

1490/91 G13

CMRR vs Frequency

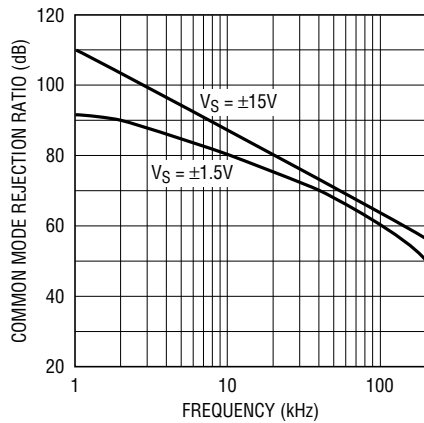

1490 G14

PSRR vs Frequency

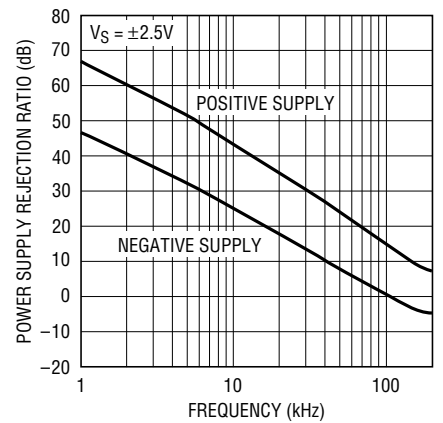

1490/91 G15

Gain Bandwidth Product and Phase Margin vs Load Resistance

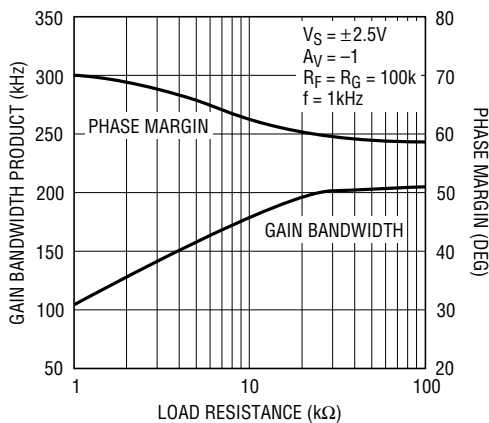

1490/91 G16

Channel Separation vs Frequency

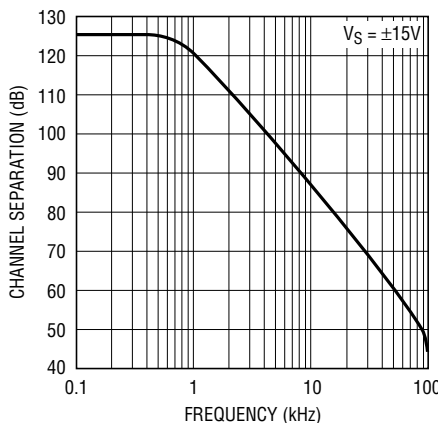

1490/91 G17

Output Impedance vs Frequency

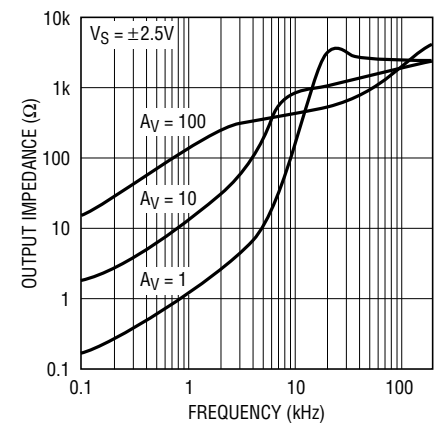

1490/91 G18

TYPICAL PERFORMANCE CHARACTERISTICS

Undistorted Output Swing vs Frequency

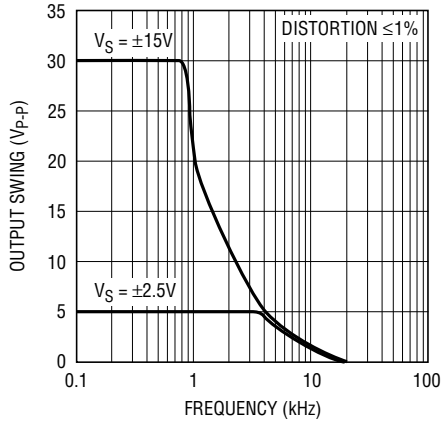

1490/91 G19

Settling Time to 0.1% vs Output Step

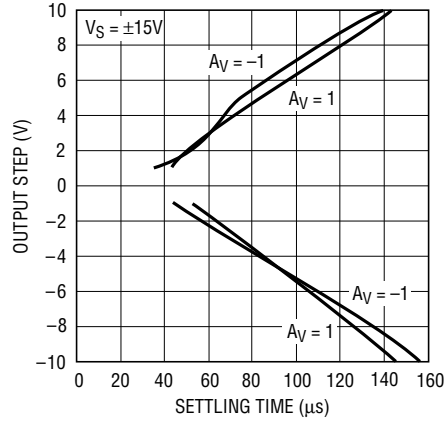

1490/91 F20

Capacitive Load Handling, Overshoot vs Capacitive Load

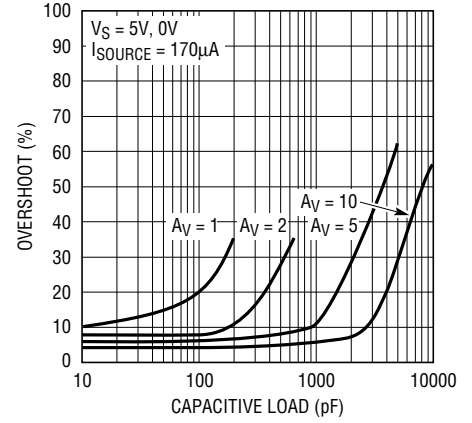

1490/91 G21

Total Harmonic Distortion + Noise vs Frequency

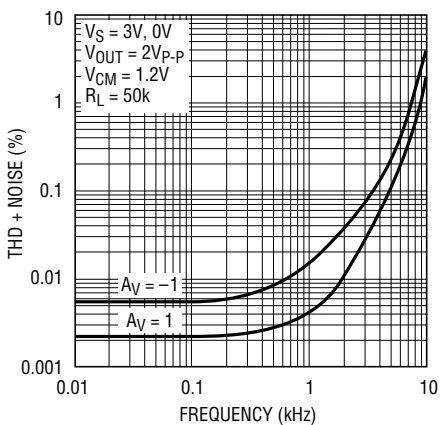

1490/91 G22

Total Harmonic Distortion + Noise vs Load Resistance

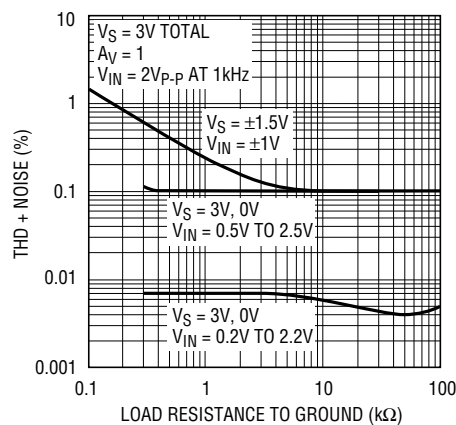

1490/91 G23

Total Harmonic Distortion + Noise vs Output Voltage

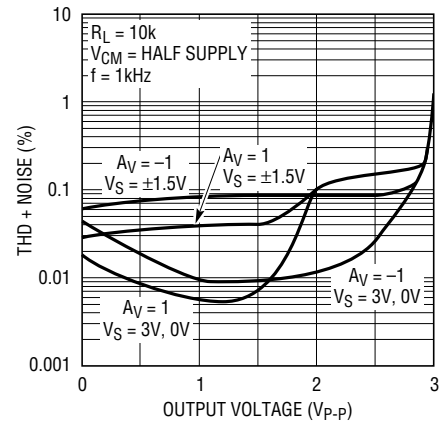

1490/91 G24

Open-Loop Gain

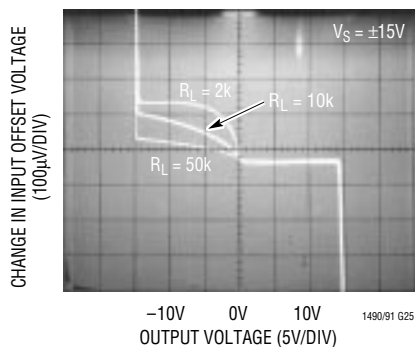

1490/91 G25

Large-Signal Response

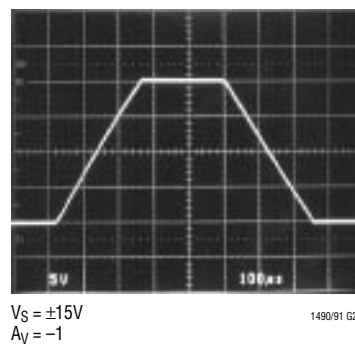

1490/91 G26

Small-Signal Response

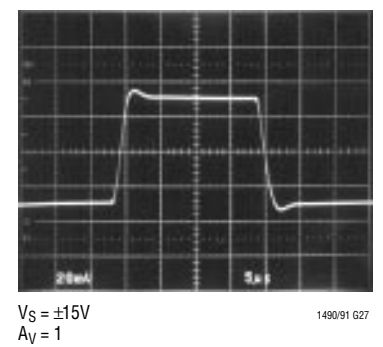

1490/91 G27

APPLICATIONS INFORMATION

Supply Voltage

The positive supply pin of the LT1490/LT1491 should be bypassed with a small capacitor (about 0.01 μ F) within an inch of the pin. When driving heavy loads an additional 4.7 μ F electrolytic capacitor should be used. When using split supplies, the same is true for the negative supply pin.

The LT1490/LT1491 are protected against reverse battery voltages up to 18V. In the event a reverse battery condition occurs, the supply current is less than 1nA.

The LT1490/LT1491 can be shut down by removing V^+ . In this condition the input bias current is less than 0.1nA, even if the inputs are 44V above the negative supply.

When operating the LT1490/LT1491 on total supplies of 30V or more, the supply must not be brought up faster than 1 μ s. This is especially true if low ESR bypass capacitors are used. A series RLC circuit is formed from the supply lead inductance and the bypass capacitor. 5 Ω of resistance in the supply or the bypass capacitor will dampen the tuned circuit enough to limit the rise time.

Inputs

The LT1490/LT1491 have two input stages, NPN and PNP (see the Simplified Schematic), resulting in three distinct operating regions as shown in the Input Bias Current vs Common Mode typical performance curve.

For input voltages about 0.8V or more below V^+ , the PNP input stage is active and the input bias current is typically -4nA. When the input voltage is about 0.5V or less from V^+ , the NPN input stage is operating and the input bias current is typically 18nA. Increases in temperature will cause the voltage at which operation switches from the PNP stage to the NPN stage to move towards V^+ . The input offset voltage of the NPN stage is untrimmed and is typically 600 μ V.

A Schottky diode in the collector of each NPN transistor of the NPN input stage allows the LT1490/LT1491 to operate with either or both of its inputs above V^+ . At about 0.3V above V^+ the NPN input transistor is fully saturated and the input bias current is typically 4 μ A at room temperature. The input offset voltage is typically 700 μ V when operating above V^+ . The LT1490/LT1491 will operate with its inputs 44V above V^- regardless of V^+ .

The inputs are protected against excursions as much as 22V below V^- by an internal 1k resistor in series with each input and a diode from the input to the negative supply. There is no output phase reversal for inputs up to 22V below V^- . There are no clamping diodes between the inputs and the maximum differential input voltage is 44V.

Output

The output voltage swing of the LT1490/LT1491 is affected by input overdrive as shown in the typical performance curves. When monitoring voltages within 100mV of either rail, gain should be taken to keep the output from clipping.

The output of the LT1490/LT1491 can be pulled up to 18V beyond V^+ with less than 1nA of leakage current, provided that V^+ is less than 0.5V.

The normally reverse-biased substrate diode from the output to V^- will cause unlimited currents to flow when the output is forced below V^- . If the current is transient and limited to 100mA, no damage will occur.

The LT1490/LT1491 is internally compensated to drive at least 200pF of capacitance under any output loading conditions. A 0.22 μ F capacitor in series with a 150 Ω resistor between the output and ground will compensate these amplifiers for larger capacitive loads, up to 10,000pF, at all output currents.

Distortion

There are two main contributors of distortion in op amps: output crossover distortion as the output transitions from sourcing to sinking current and distortion caused by nonlinear common mode rejection. Of course, if the op amp is operating inverting there is no common mode induced distortion. When the LT1490 switches between input stages there is significant nonlinearity in the CMRR. Lower load resistance increases the output crossover distortion, but has no effect on the input stage transition distortion. For lowest distortion the LT1490/LT1491 should be operated single supply, with the output always sourcing current and with the input voltage swing between ground and ($V^+ - 0.8V$). See the Typical Performance Characteristics curves.

APPLICATIONS INFORMATION

Gain

The open-loop gain is almost independent of load when the output is sourcing current. This optimizes perfor-

mance in single supply applications where the load is returned to ground. The typical performance photo of Open-Loop Gain for various loads shows the details.

TYPICAL APPLICATIONS

Square Wave Oscillator

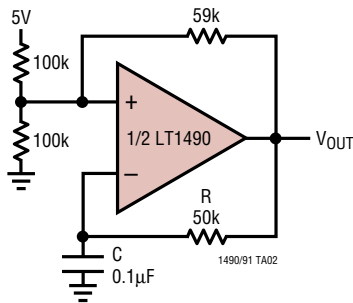

$$f = \frac{1}{2RC}$$

$V_{OUT} = 5V_{P-P}$ WITH 5V SUPPLY

$I_S = 200\mu A$

AT $V_S = 5V$, $R = 50k$, $C = 1nF$
OUTPUT IS 5kHz SLEW LIMITED TRIANGLE WAVE

Optional Output Compensation for Capacitive Loads Greater Than 200pF

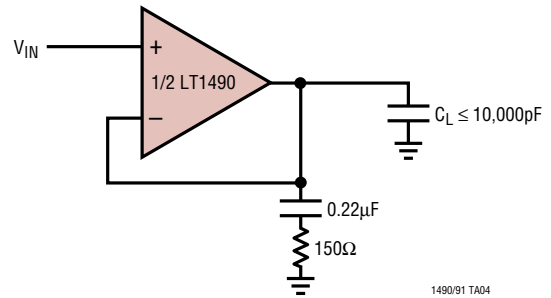

SIMPLIFIED SCHEMATIC

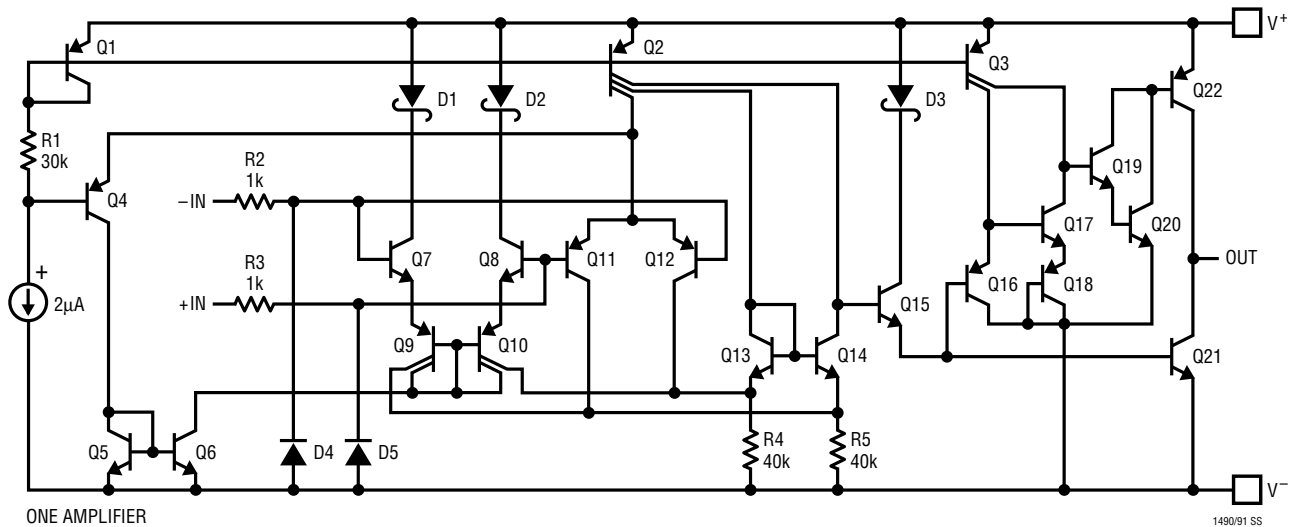

PACKAGE DESCRIPTION Dimensions in inches (millimeters) unless otherwise noted.

MS Package
8-Lead Plastic MSOP
 (LTC DWG # 05-08-1660)

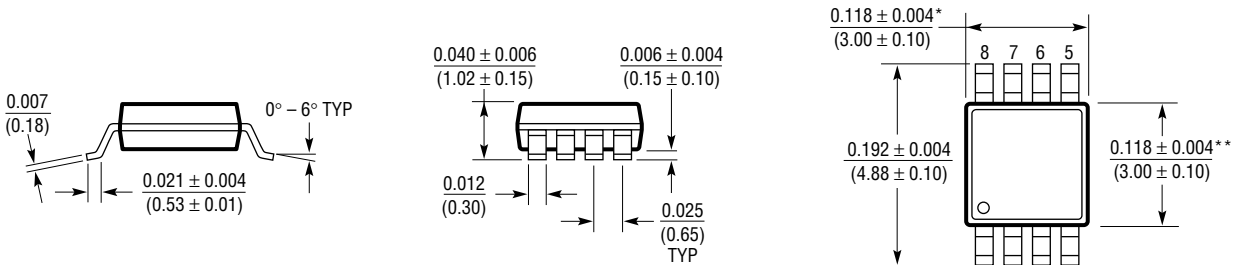

* DIMENSION DOES NOT INCLUDE MOLD FLASH, PROTRUSIONS OR GATE BURRS. MOLD FLASH, PROTRUSIONS OR GATE BURRS SHALL NOT EXCEED 0.006" (0.152mm) PER SIDE

** DIMENSION DOES NOT INCLUDE INTERLEAD FLASH OR PROTRUSIONS. INTERLEAD FLASH OR PROTRUSIONS SHALL NOT EXCEED 0.006" (0.152mm) PER SIDE

N8 Package
8-Lead PDIP (Narrow 0.300)
 (LTC DWG # 05-08-1510)

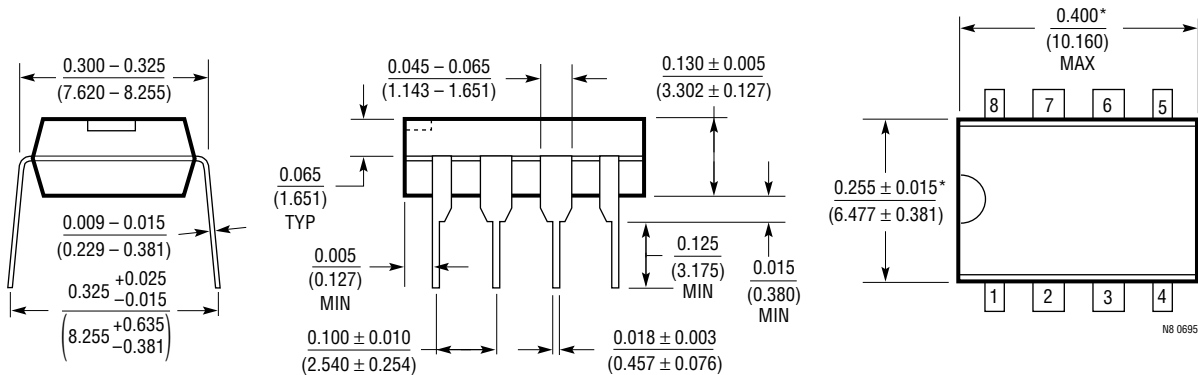

*THESE DIMENSIONS DO NOT INCLUDE MOLD FLASH OR PROTRUSIONS. MOLD FLASH OR PROTRUSIONS SHALL NOT EXCEED 0.010 INCH (0.254mm)

S8 Package
8-Lead Plastic Small Outline (Narrow 0.150)
 (LTC DWG # 05-08-1610)

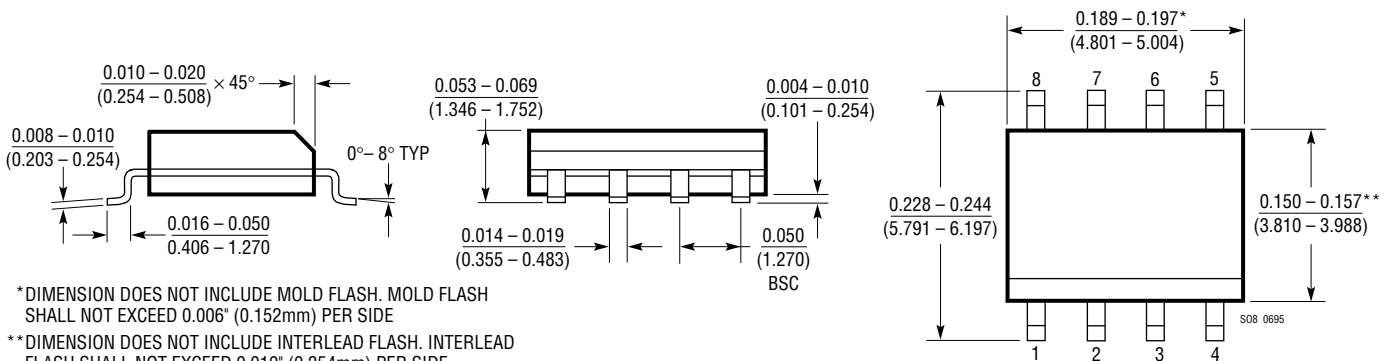

* DIMENSION DOES NOT INCLUDE MOLD FLASH. MOLD FLASH SHALL NOT EXCEED 0.006" (0.152mm) PER SIDE

** DIMENSION DOES NOT INCLUDE INTERLEAD FLASH. INTERLEAD FLASH SHALL NOT EXCEED 0.010" (0.254mm) PER SIDE

PACKAGE DESCRIPTION Dimensions in inches (millimeters) unless otherwise noted.

N Package
14-Lead PDIP (Narrow 0.300)
 (LTC DWG # 05-08-1510)

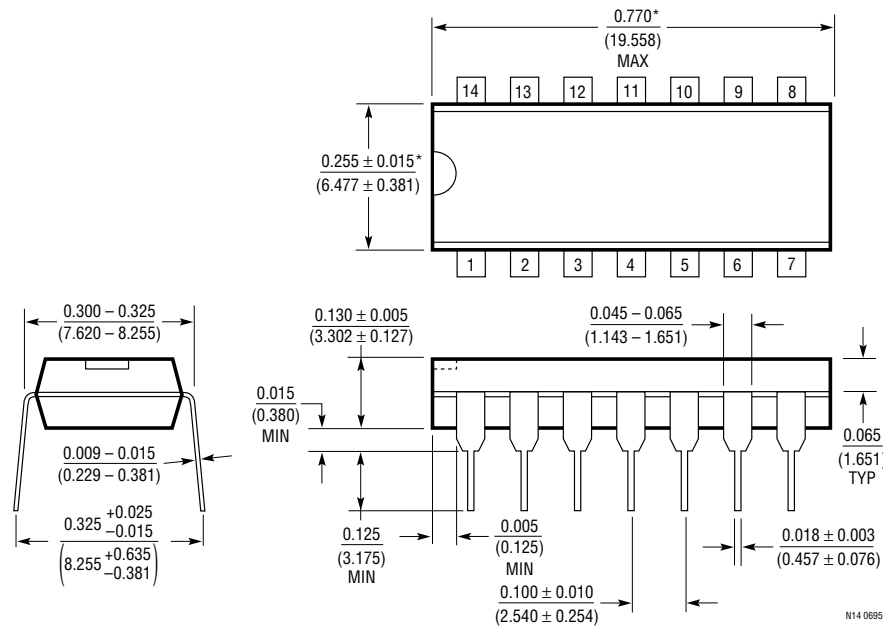

*THESE DIMENSIONS DO NOT INCLUDE MOLD FLASH OR PROTRUSIONS.
 MOLD FLASH OR PROTRUSIONS SHALL NOT EXCEED 0.010 INCH (0.254mm)

S Package
14-Lead Plastic Small Outline (Narrow 0.150)
 (LTC DWG # 05-08-1610)

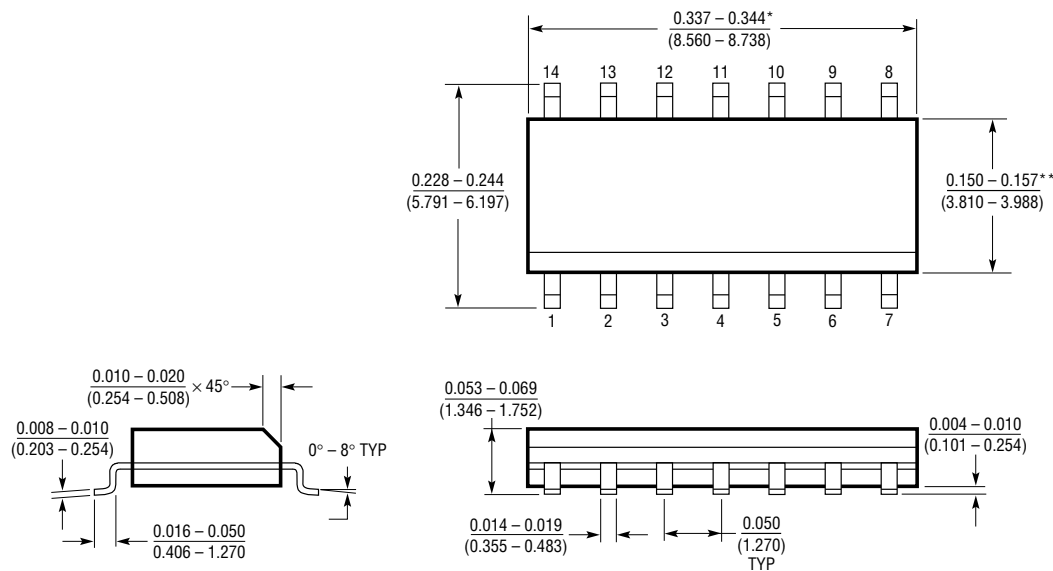

*DIMENSION DOES NOT INCLUDE MOLD FLASH. MOLD FLASH SHALL NOT EXCEED 0.006" (0.152mm) PER SIDE
 **DIMENSION DOES NOT INCLUDE INTERLEAD FLASH. INTERLEAD FLASH SHALL NOT EXCEED 0.010" (0.254mm) PER SIDE

TYPICAL APPLICATION

Ring-Tone Generator

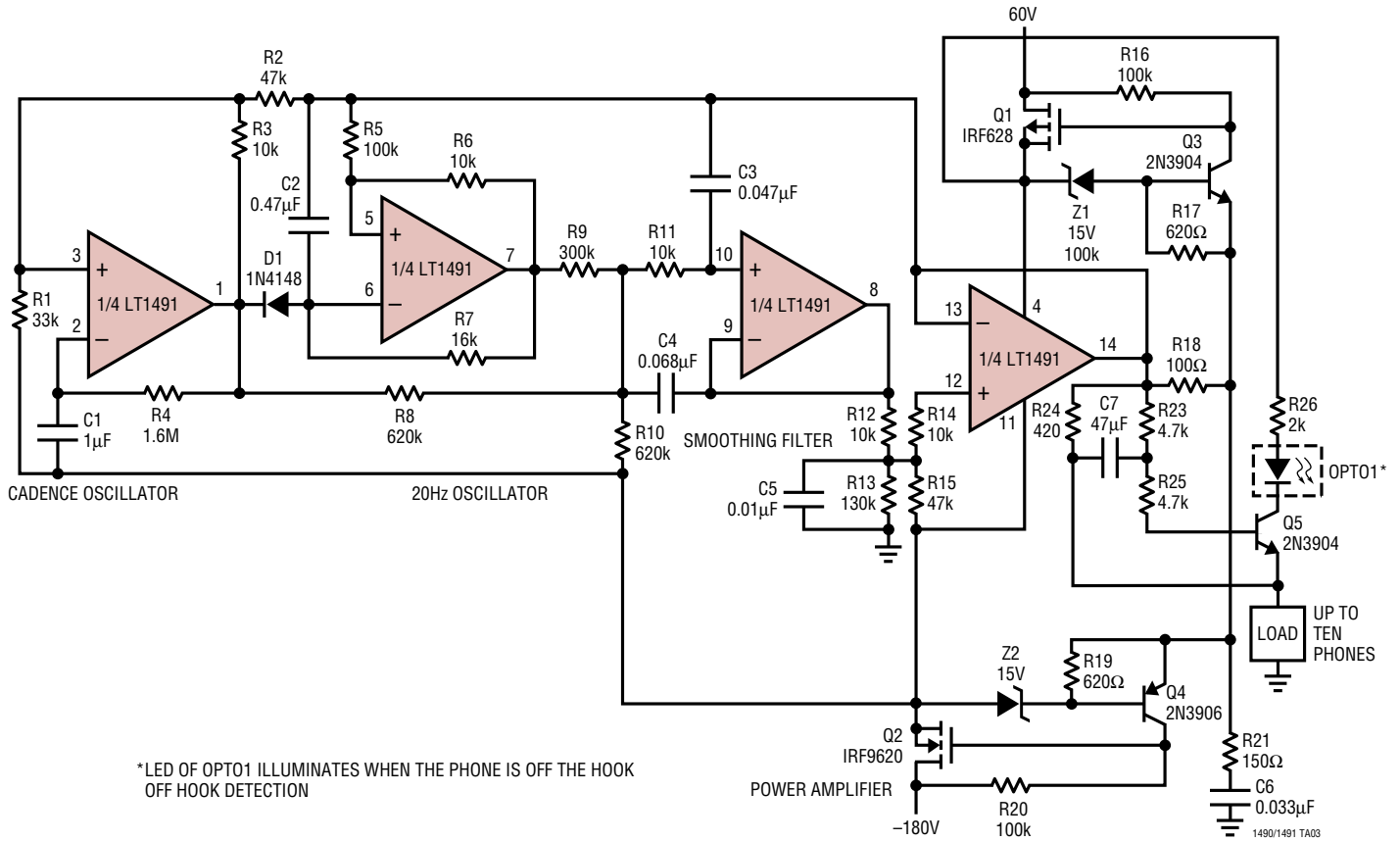

RELATED PARTS

PART NUMBER	DESCRIPTION	COMMENTS
LT1078/LT1079	Dual/Quad 55µA Max, Single Supply, Precision Op Amps	Input/Output Common Mode Includes Ground, 70µV V _{OS(MAX)} and 2.5µV/°C Drift (Max), 200kHz GBW, 0.07V/µs Slew Rate
LTC1152	Rail-to-Rail Input, Rail-to-Rail Output, Zero-Drift Amplifier	High DC Accuracy, 10µV V _{OS(MAX)} , 100nV/°C, 1MHz GBW, 1V/µs Slew Rate, Supply Current 2.2mA (Max), Single Supply, Can Be Configured for C-Load™ Operation
LT1178/LT1179	Dual/Quad 17µA Max, Single Supply, Precision Op Amps	Input/Output Common Mode Includes Ground, 70µV V _{OS(MAX)} and 4µV/°C Drift (Max), 85kHz GBW, 0.04V/µs Slew Rate
LT1366/LT1367	Dual/Quad Precision, Rail-to-Rail Input and Output Op Amps	475µV V _{OS(MAX)} , 500V/mV A _{VOL(MIN)} , 400kHz GBW

C-Load is a trademark of Linear Technology Corporation.