

Single/Dual 180MHz, 350V/ μ s Rail-to-Rail Input and Output Low Distortion Op Amps

FEATURES

- **-3dB Bandwidth: 320MHz, $A_V = 1$**
- **Gain-Bandwidth Product: 180MHz, $A_V \geq 10$**
- **Slew Rate: 350V/ μ s**
- **Wide Supply Range: 2.5V to 12.6V**
- **Large Output Current: 85mA**
- **Low Distortion, 5MHz: -90dBc**
- Input Common Mode Range Includes Both Rails
- Output Swings Rail-to-Rail
- Input Offset Voltage, Rail-to-Rail: 2.5mV Max
- Common Mode Rejection: 89dB Typ
- Power Supply Rejection: 87dB Typ
- Open-Loop Gain: 100V/mV Typ
- Shutdown Pin: LT1809
- Single in 8-Pin SO and 6-Pin SOT-23 Packages
- Dual in 8-Pin SO and MSOP Packages
- Operating Temperature Range: -40°C to 85°C

APPLICATIONS

- Driving A/D Converters
- Low Voltage Signal Processing
- Active Filters
- Rail-to-Rail Buffer Amplifiers
- Video Line Driver

 LTC and LT are registered trademarks of Linear Technology Corporation.

DESCRIPTION

The LT[®]1809/LT1810 are single/dual low distortion rail-to-rail input and output op amps with a 350V/ μ s slew rate. These amplifiers have a -3dB bandwidth of 320MHz at unity-gain, a gain-bandwidth product of 180MHz ($A_V \geq 10$) and an 85mA output current to fit the needs of low voltage, high performance signal conditioning systems.

The LT1809/LT1810 have an input range that includes both supply rails and an output that swings within 20mV of either supply rail to maximize the signal dynamic range in low supply applications.

The LT1809/LT1810 have very low distortion (-90dBc) up to 5MHz that allows them to be used in high performance data acquisition systems.

The LT1809/LT1810 maintain their performance for supplies from 2.5V to 12.6V and are specified at 3V, 5V and ± 5 V supplies. The inputs can be driven beyond the supplies without damage or phase reversal of the output.

The LT1809 is available in the 8-pin SO package with the standard op amp pinout and the 6-pin SOT-23 package. The LT1810 features the standard dual op amp pinout and is available in 8-pin SO and MSOP packages. These devices can be used as a plug-in replacement for many op amps to improve input/output range and performance.

TYPICAL APPLICATION

High Speed ADC Driver

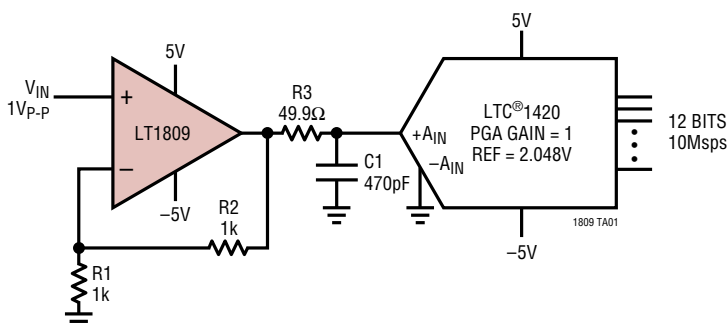

Distortion vs Frequency

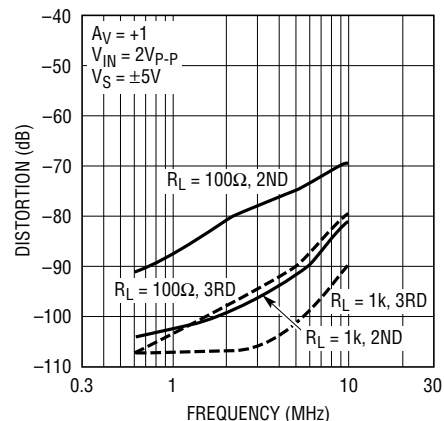

1809 TA02

LT1809/LT1810

ABSOLUTE MAXIMUM RATINGS (Note 1)

Total Supply Voltage (V^+ to V^-)	12.6V	Specified Temperature Range (Note 5) ...	-40°C to 85°C
Input Voltage (Note 2)	$\pm V_S$	Junction Temperature	150°C
Input Current (Note 2)	$\pm 10\text{mA}$	Storage Temperature Range	-65°C to 150°C
Output Short-Circuit Duration (Note 3)	Indefinite	Lead Temperature (Soldering, 10 sec)	300°C
Operating Temperature Range (Note 4) ..	-40°C to 85°C		

PACKAGE/ORDER INFORMATION

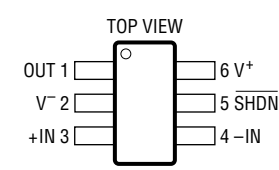
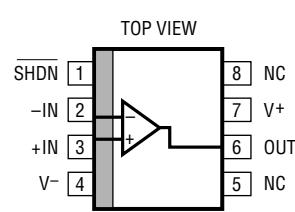
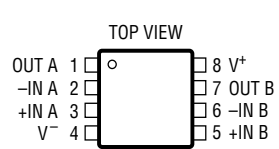
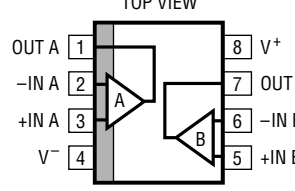
 <p>S6 PACKAGE 6-LEAD PLASTIC SOT-23</p> <p>$T_{JMAX} = 150^{\circ}\text{C}$, $\theta_{JA} = 145^{\circ}\text{C/W}$ (Note 9)</p>	ORDER PART NUMBER	 <p>S8 PACKAGE 8-LEAD PLASTIC SO</p> <p>$T_{JMAX} = 150^{\circ}\text{C}$, $\theta_{JA} = 100^{\circ}\text{C/W}$ (Note 9)</p>	ORDER PART NUMBER
	LT1809CS6 LT1809IS6		LT1809CS8 LT1809IS8
	S6 PART MARKING		S8 PART MARKING
	LTKY LTUF		1809 1809I
 <p>MS8 PACKAGE 8-LEAD PLASTIC MSOP</p> <p>$T_{JMAX} = 150^{\circ}\text{C}$, $\theta_{JA} = 130^{\circ}\text{C/W}$ (Note 9)</p>	ORDER PART NUMBER	 <p>S8 PACKAGE 8-LEAD PLASTIC SO</p> <p>$T_{JMAX} = 150^{\circ}\text{C}$, $\theta_{JA} = 100^{\circ}\text{C/W}$ (Note 9)</p>	ORDER PART NUMBER
	LT1810CMS8 LT1810IMS8		LT1810CS8 LT1810IS8
	MS8 PART MARKING		S8 PART MARKING
	LTRF LTTQ		1810 1810I

Consult factory for parts specified with wider operating temperature ranges.

ELECTRICAL CHARACTERISTICS

$T_A = 25^{\circ}\text{C}$. $V_S = 5\text{V}$, 0V ; $V_S = 3\text{V}$, 0V ; $V_{SHDN} = \text{open}$; $V_{CM} = V_{OUT} = \text{half supply}$, unless otherwise noted.

SYMBOL	PARAMETER	CONDITIONS	MIN	TYP	MAX	UNITS
V_{OS}	Input Offset Voltage	$V_{CM} = V^+$ LT1809 SO-8		0.6	2.5	mV
		$V_{CM} = V^-$ LT1809 SO-8		0.6	2.5	mV
		$V_{CM} = V^+$		0.6	3.0	mV
		$V_{CM} = V^-$		0.6	3.0	mV
ΔV_{OS}	Input Offset Shift	$V_{CM} = V^-$ to V^+ LT1809 SO-8		0.3	2.0	mV
		$V_{CM} = V^-$ to V^+		0.3	2.5	mV
	Input Offset Voltage Match (Channel-to-Channel) (Note 10)			0.7	6	mV
I_B	Input Bias Current	$V_{CM} = V^+$		1.8	8	μA
		$V_{CM} = V^- + 0.2\text{V}$	-27.5	-13		μA
ΔI_B	Input Bias Current Shift	$V_{CM} = V^- + 0.2\text{V}$ to V^+		14.8	35.5	μA
		$V_{CM} = V^+$		0.1	4	μA
	Input Bias Current Match (Channel-to-Channel) (Note 10)	$V_{CM} = V^- + 0.2\text{V}$		0.2	8	μA

ELECTRICAL CHARACTERISTICS

$T_A = 25^\circ\text{C}$. $V_S = 5\text{V}$, 0V ; $V_S = 3\text{V}$, 0V ; $V_{\overline{\text{SHDN}}} = \text{open}$; $V_{\text{CM}} = V_{\text{OUT}} = \text{half supply}$, unless otherwise noted.

SYMBOL	PARAMETER	CONDITIONS	MIN	TYP	MAX	UNITS
I_{OS}	Input Offset Current	$V_{\text{CM}} = V^+$		0.05	1.2	μA
		$V_{\text{CM}} = V^- + 0.2\text{V}$		0.2	4	μA
ΔI_{OS}	Input Offset Current Shift	$V_{\text{CM}} = V^- + 0.2\text{V}$ to V^+		0.25	5.2	μA
e_n	Input Noise Voltage Density	$f = 10\text{kHz}$		16		$\text{nV}/\sqrt{\text{Hz}}$
i_n	Input Noise Current Density	$f = 10\text{kHz}$		5		$\text{pA}/\sqrt{\text{Hz}}$
C_{IN}	Input Capacitance			2		pF
A_{VOL}	Large-Signal Voltage Gain	$V_S = 5\text{V}$, $V_O = 0.5\text{V}$ to 4.5V , $R_L = 1\text{k}$ to $V_S/2$	25	80		V/mV
		$V_S = 5\text{V}$, $V_O = 1\text{V}$ to 4V , $R_L = 100\Omega$ to $V_S/2$	4	10		V/mV
		$V_S = 3\text{V}$, $V_O = 0.5\text{V}$ to 2.5V , $R_L = 1\text{k}$ to $V_S/2$	15	42		V/mV
CMRR	Common Mode Rejection Ratio	$V_S = 5\text{V}$, $V_{\text{CM}} = V^-$ to V^+	66	82		dB
		$V_S = 3\text{V}$, $V_{\text{CM}} = V^-$ to V^+	61	78		dB
	CMRR Match (Channel-to-Channel) (Note 10)	$V_S = 5\text{V}$, $V_{\text{CM}} = V^-$ to V^+ $V_S = 3\text{V}$, $V_{\text{CM}} = V^-$ to V^+	60 55	82 78		dB dB
	Input Common Mode Range		V^-		V^+	V
PSRR	Power Supply Rejection Ratio	$V_S = 2.5\text{V}$ to 10V , $V_{\text{CM}} = 0\text{V}$	71	87		dB
		PSRR Match (Channel-to-Channel) (Note 10)	65	87		dB
		Minimum Supply Voltage (Note 6)		2.3	2.5	
V_{OL}	Output Voltage Swing LOW (Note 7)	No Load		12	50	mV
		$I_{\text{SINK}} = 5\text{mA}$		50	120	mV
		$I_{\text{SINK}} = 25\text{mA}$		180	375	mV
V_{OH}	Output Voltage Swing HIGH (Note 7)	No Load		20	80	mV
		$I_{\text{SOURCE}} = 5\text{mA}$		80	180	mV
		$I_{\text{SOURCE}} = 25\text{mA}$		330	650	mV
I_{SC}	Short-Circuit Current	$V_S = 5\text{V}$	± 45	± 85		mA
		$V_S = 3\text{V}$	± 35	± 70		mA
I_S	Supply Current per Amplifier			12.5	17	mA
		Supply Current, Shutdown	$V_S = 5\text{V}$, $V_{\overline{\text{SHDN}}} = 0.3\text{V}$ $V_S = 3\text{V}$, $V_{\overline{\text{SHDN}}} = 0.3\text{V}$	0.55 0.31	1.25 0.90	mA mA
$I_{\overline{\text{SHDN}}}$	SHDN Pin Current	$V_S = 5\text{V}$, $V_{\overline{\text{SHDN}}} = 0.3\text{V}$		420	750	μA
		$V_S = 3\text{V}$, $V_{\overline{\text{SHDN}}} = 0.3\text{V}$		220	500	μA
	Output Leakage Current, Shutdown	$V_{\overline{\text{SHDN}}} = 0.3\text{V}$		0.1	75	μA
V_L	SHDN Pin Input Voltage Low				0.3	V
V_H	SHDN Pin Input Voltage High		$V_S - 0.5$			V
t_{ON}	Turn-On Time	$V_{\overline{\text{SHDN}}} = 0.3\text{V}$ to 4.5V , $R_L = 100$		80		ns
t_{OFF}	Turn-Off Time	$V_{\overline{\text{SHDN}}} = 4.5\text{V}$ to 0.3V , $R_L = 100$		50		ns
GBW	Gain-Bandwidth Product	Frequency = 2MHz		160		MHz
SR	Slew Rate	$V_S = 5\text{V}$, $A_V = -1$, $R_L = 1\text{k}$, $V_O = 4V_{\text{P-P}}$		300		$\text{V}/\mu\text{s}$
FPBW	Full Power Bandwidth	$V_S = 5\text{V}$, $V_{\text{OUT}} = 4V_{\text{P-P}}$		23.5		MHz
THD	Total Harmonic Distortion	$V_S = 5\text{V}$, $A_V = 1$, $R_L = 1\text{k}$, $V_O = 2V_{\text{P-P}}$, $f_C = 5\text{MHz}$		-86		dB
t_S	Settling Time	0.1%, $V_S = 5\text{V}$, $V_{\text{STEP}} = 2\text{V}$, $A_V = -1$, $R_L = 500\Omega$		27		ns
ΔG	Differential Gain (NTSC)	$V_S = 5\text{V}$, $A_V = 2$, $R_L = 150\Omega$		0.015		%
$\Delta\theta$	Differential Phase (NTSC)	$V_S = 5\text{V}$, $A_V = 2$, $R_L = 150\Omega$		0.05		Deg

ELECTRICAL CHARACTERISTICS

The ● denotes the specifications which apply over the 0°C ≤ T_A ≤ 70°C temperature range. V_S = 5V, 0V; V_S = 3V, 0V; V_{SHDN} = open; V_{CM} = V_{OUT} = half supply, unless otherwise noted.

SYMBOL	PARAMETER	CONDITIONS		MIN	TYP	MAX	UNITS
V _{OS}	Input Offset Voltage	V _{CM} = V ⁺ LT1809 SO-8	●		1	3.0	mV
		V _{CM} = V ⁻ LT1809 SO-8	●		1	3.0	mV
		V _{CM} = V ⁺	●		1	3.5	mV
		V _{CM} = V ⁻	●		1	3.5	mV
V _{OS} TC	Input Offset Voltage Drift (Note 8)	V _{CM} = V ⁺	●		9	25	μV/°C
		V _{CM} = V ⁻	●		9	25	μV/°C
ΔV _{OS}	Input Offset Voltage Shift	V _{CM} = V ⁻ to V ⁺ LT1809 SO-8	●		0.5	2.5	mV
		V _{CM} = V ⁻ to V ⁺	●		0.5	3.0	mV
	Input Offset Voltage Match (Channel-to-Channel) (Note 10)	V _{CM} = V ⁻ , V _{CM} = V ⁺	●		1.2	6.5	mV
I _B	Input Bias Current	V _{CM} = V ⁺ - 0.2V	●		2	10	μA
		V _{CM} = V ⁻ + 0.4V	●	-30	-14		μA
ΔI _B	Input Bias Current Shift	V _{CM} = V ⁻ + 0.4V to V ⁺ - 0.2V	●		16	40	μA
	Input Bias Current Match (Channel-to-Channel) (Note 10)	V _{CM} = V ⁺ - 0.2V	●		0.1	5	μA
		V _{CM} = V ⁻ + 0.4V	●		0.5	10	μA
I _{OS}	Input Offset Current	V _{CM} = V ⁺ - 0.2V	●		0.05	1.5	μA
		V _{CM} = V ⁻ + 0.4V	●		0.40	4.5	μA
ΔI _{OS}	Input Offset Current Shift	V _{CM} = V ⁻ + 0.4V to V ⁺ - 0.2V	●		0.45	6	μA
A _{VOL}	Large-Signal Voltage Gain	V _S = 5V, V _O = 0.5V to 4.5V, R _L = 1k to V _S /2	●	20	75		V/mV
		V _S = 5V, V _O = 1V to 4V, R _L = 100Ω to V _S /2	●	3.5	8.5		V/mV
		V _S = 3V, V _O = 0.5V to 2.5V, R _L = 1k to V _S /2	●	12	40		V/mV
CMRR	Common Mode Rejection Ratio	V _S = 5V, V _{CM} = V ⁻ to V ⁺	●	64	80		dB
		V _S = 3V, V _{CM} = V ⁻ to V ⁺	●	60	75		dB
	CMRR Match (Channel-to-Channel) (Note 10)	V _S = 5V, V _{CM} = V ⁻ , V _{CM} = V ⁺	●	58	80		dB
		V _S = 3V, V _{CM} = V ⁻ , V _{CM} = V ⁺	●	54	75		dB
	Input Common Mode Range		●	V ⁻		V ⁺	V
PSRR	Power Supply Rejection Ratio	V _S = 2.5V to 10V, V _{CM} = 0V	●	70	83		dB
		V _S = 2.5V to 10V, V _{CM} = 0V	●	64	83		dB
	Minimum Supply Voltage (Note 6)		●		2.3	2.5	V
V _{OL}	Output Voltage Swing LOW (Note 7)	No Load	●		12	60	mV
		I _{SINK} = 5mA	●		55	140	mV
		I _{SINK} = 25mA	●		200	400	mV
V _{OH}	Output Voltage Swing HIGH (Note 7)	No Load	●		50	120	mV
		I _{SOURCE} = 5mA	●		110	220	mV
		I _{SOURCE} = 25mA	●		370	700	mV
I _{SC}	Short-Circuit Current	V _S = 5V	●	±40	±75		mA
		V _S = 3V	●	±30	±65		mA
I _S	Supply Current per Amplifier		●		15	20	mA
			●				
	Supply Current, Shutdown	V _S = 5V, V _{SHDN} = 0.3V	●		0.58	1.4	mA
		V _S = 3V, V _{SHDN} = 0.3V	●		0.35	1.1	mA
I _{SHDN}	SHDN Pin Current	V _S = 5V, V _{SHDN} = 0.3V	●		420	850	μA
		V _S = 3V, V _{SHDN} = 0.3V	●		220	550	μA
	Output Leakage Current, Shutdown	V _{SHDN} = 0.3V	●		2		μA
V _L	SHDN Pin Input Voltage Low		●			0.3	V
V _H	SHDN Pin Input Voltage High		●	V _S - 0.5			V

ELECTRICAL CHARACTERISTICS

The ● denotes the specifications which apply over the $0^{\circ}\text{C} \leq T_A \leq 70^{\circ}\text{C}$ temperature range. $V_S = 5\text{V}, 0\text{V}; V_S = 3\text{V}, 0\text{V}; V_{\text{SHDN}} = \text{open}; V_{\text{CM}} = V_{\text{OUT}} = \text{half supply, unless otherwise noted.}$

SYMBOL	PARAMETER	CONDITIONS	MIN	TYP	MAX	UNITS
t_{ON}	Turn-On Time	$V_{\text{SHDN}} = 0.3\text{V to } 4.5\text{V}, R_L = 100$	●	80		ns
t_{OFF}	Turn-Off Time	$V_{\text{SHDN}} = 4.5\text{V to } 0.3\text{V}, R_L = 100$	●	50		ns
GBW	Gain-Bandwidth Product	Frequency = 2MHz	●	145		MHz
SR	Slew Rate	$V_S = 5\text{V}, A_V = -1, R_L = 1\text{k}, V_O = 4V_{\text{P-P}}$	●	250		V/ μs
FPBW	Full Power Bandwidth	$V_S = 5\text{V}, V_{\text{OUT}} = 4V_{\text{P-P}}$	●	20		MHz

The ● denotes the specifications which apply over the $-40^{\circ}\text{C} \leq T_A \leq 85^{\circ}\text{C}$ temperature range. $V_S = 5\text{V}, 0\text{V}; V_S = 3\text{V}, 0\text{V}; V_{\text{SHDN}} = \text{open}; V_{\text{CM}} = V_{\text{OUT}} = \text{half supply, unless otherwise noted. (Note 5)}$

SYMBOL	PARAMETER	CONDITIONS	MIN	TYP	MAX	UNITS
V_{OS}	Input Offset Voltage	$V_{\text{CM}} = V^+$ LT1809 SO-8	●	1	3.5	mV
		$V_{\text{CM}} = V^-$ LT1809 SO-8	●	1	3.5	mV
		$V_{\text{CM}} = V^+$	●	1	4.0	mV
		$V_{\text{CM}} = V^-$	●	1	4.0	mV
$V_{\text{OS TC}}$	Input Offset Voltage Drift (Note 8)	$V_{\text{CM}} = V^+$	●	9	25	$\mu\text{V}/^{\circ}\text{C}$
		$V_{\text{CM}} = V^-$	●	9	25	$\mu\text{V}/^{\circ}\text{C}$
ΔV_{OS}	Input Offset Voltage Shift	$V_{\text{CM}} = V^-$ to V^+ LT1809 SO-8	●	0.5	3.0	mV
		$V_{\text{CM}} = V^-$	●	0.5	3.5	mV
	Input Offset Voltage Match (Channel-to-Channel) (Note 10)	$V_{\text{CM}} = V^+, V_{\text{CM}} = V^-$	●	1.2	7	mV
I_B	Input Bias Current	$V_{\text{CM}} = V^+ - 0.2\text{V}$	●	2	12	μA
		$V_{\text{CM}} = V^- + 0.4\text{V}$	●	-35	-17	μA
ΔI_B	Input Bias Current Shift	$V_{\text{CM}} = V^- + 0.4\text{V to } V^+ - 0.2\text{V}$	●	19	47	μA
		Input Bias Current Match (Channel-to-Channel) (Note 10)	$V_{\text{CM}} = V^+ - 0.2\text{V}$	●	0.2	6
		$V_{\text{CM}} = V^- + 0.4\text{V}$	●	0.6	12	μA
I_{OS}	Input Offset Current	$V_{\text{CM}} = V^+ - 0.2\text{V}$	●	0.08	2	μA
		$V_{\text{CM}} = V^- + 0.4\text{V}$	●	0.5	6	μA
ΔI_{OS}	Input Offset Current Shift	$V_{\text{CM}} = V^- + 0.4\text{V to } V^+ - 0.2\text{V}$	●	0.58	7.5	μA
A_{VOL}	Large-Signal Voltage Gain	$V_S = 5\text{V}, V_O = 0.5\text{V to } 4.5\text{V}, R_L = 1\text{k to } V_S/2$	●	17	60	V/mV
		$V_S = 5\text{V}, V_O = 1\text{V to } 4\text{V}, R_L = 100\Omega \text{ to } V_S/2$	●	2.5	7	V/mV
		$V_S = 3\text{V}, V_O = 0.5\text{V to } 2.5\text{V}, R_L = 1\text{k to } V_S/2$	●	10	35	V/mV
CMRR	Common Mode Rejection Ratio	$V_S = 5\text{V}, V_{\text{CM}} = V^- \text{ to } V^+$	●	63	80	dB
		$V_S = 3\text{V}, V_{\text{CM}} = V^- \text{ to } V^+$	●	58	75	dB
	CMRR Match (Channel-to-Channel) (Note 10)	$V_S = 5\text{V}, V_{\text{CM}} = V^- \text{ to } V^+$	●	57	78	dB
		$V_S = 3\text{V}, V_{\text{CM}} = V^- \text{ to } V^+$	●	52	72	dB
	Input Common Mode Range		●	V^-	V^+	V
PSRR	Power Supply Rejection Ratio	$V_S = 2.5\text{V to } 10\text{V}, V_{\text{CM}} = 0\text{V}$	●	69	83	dB
		PSRR Match (Channel-to-Channel) (Note 10)	$V_S = 2.5\text{V to } 10\text{V}, V_{\text{CM}} = 0\text{V}$	●	63	83
	Minimum Supply Voltage (Note 6)		●	2.3	2.5	V
V_{OL}	Output Voltage Swing LOW (Note 7)	No Load	●	18	70	mV
		$I_{\text{SINK}} = 5\text{mA}$	●	60	150	mV
		$I_{\text{SINK}} = 25\text{mA}$	●	210	450	mV
V_{OH}	Output Voltage Swing HIGH (Note 7)	No Load	●	55	130	mV
		$I_{\text{SOURCE}} = 5\text{mA}$	●	120	240	mV
		$I_{\text{SOURCE}} = 25\text{mA}$	●	375	750	mV
I_{SC}	Short-Circuit Current	$V_S = 5\text{V}$	●	± 30	± 70	mA
		$V_S = 3\text{V}$	●	± 25	± 60	mA
I_S	Supply Current per Amplifier		●	15	21	mA
		Supply Current, Shutdown	$V_S = 5\text{V}, V_{\text{SHDN}} = 0.3\text{V}$	●	0.58	1.5
		$V_S = 3\text{V}, V_{\text{SHDN}} = 0.3\text{V}$	●	0.35	1.2	mA

ELECTRICAL CHARACTERISTICS

The ● denotes the specifications which apply over the $-40^{\circ}\text{C} \leq T_A \leq 85^{\circ}\text{C}$ temperature range. $V_S = 5\text{V}, 0\text{V}$; $V_S = 3\text{V}, 0\text{V}$; $V_{\text{SHDN}} = \text{open}$; $V_{\text{CM}} = V_{\text{OUT}} = \text{half supply}$, unless otherwise noted. (Note 5)

SYMBOL	PARAMETER	CONDITIONS	MIN	TYP	MAX	UNITS
I_{SHDN}	SHDN Pin Current	$V_S = 5\text{V}, V_{\text{SHDN}} = 0.3\text{V}$	●	420	900	μA
		$V_S = 3\text{V}, V_{\text{SHDN}} = 0.3\text{V}$	●	220	600	μA
	Output Leakage Current, Shutdown	$V_{\text{SHDN}} = 0.3\text{V}$	●	3		μA
V_L	SHDN Pin Input Voltage Low		●		0.3	V
V_H	SHDN Pin Input Voltage High		●	$V_S - 0.5$		V
t_{ON}	Turn-On Time	$V_{\text{SHDN}} = 0.3\text{V}$ to 4.5V , $R_L = 100$	●	80		ns
t_{OFF}	Turn-Off Time	$V_{\text{SHDN}} = 4.5\text{V}$ to 0.3V , $R_L = 100$	●	50		ns
GBW	Gain-Bandwidth Product	Frequency = 2MHz	●	140		MHz
SR	Slew Rate	$V_S = 5\text{V}$, $A_V = -1$, $R_L = 1\text{k}$, $V_O = 4V_{\text{P-P}}$	●	180		V/ μs
FPBW	Full Power Bandwidth	$V_S = 5\text{V}$, $V_{\text{OUT}} = 4V_{\text{P-P}}$	●	14		MHz

$T_A = 25^{\circ}\text{C}$. $V_S = \pm 5\text{V}$, $V_{\text{SHDN}} = \text{open}$, $V_{\text{CM}} = 0\text{V}$, $V_{\text{OUT}} = 0\text{V}$, unless otherwise noted.

SYMBOL	PARAMETER	CONDITIONS	MIN	TYP	MAX	UNITS
V_{OS}	Input Offset Voltage	$V_{\text{CM}} = V^+$ LT1809 SO-8		0.8	3.0	mV
		$V_{\text{CM}} = V^-$ LT1809 SO-8		0.8	3.0	mV
		$V_{\text{CM}} = V^+$		0.8	3.5	mV
		$V_{\text{CM}} = V^-$		0.8	3.5	mV
ΔV_{OS}	Input Offset Voltage Shift	$V_{\text{CM}} = V^-$ to V^+ LT1809 SO-8		0.35	2.5	mV
		$V_{\text{CM}} = V^-$ to V^+		0.35	3.0	mV
	Input Offset Voltage Match (Channel-to-Channel) (Note 10)	$V_{\text{CM}} = V^+$, $V_{\text{CM}} = V^-$		1	6	mV
I_B	Input Bias Current	$V_{\text{CM}} = V^+$ $V_{\text{CM}} = V^- + 0.2\text{V}$	-30	2 -12.5	10	μA μA
ΔI_B	Input Bias Current Shift	$V_{\text{CM}} = V^- + 0.2\text{V}$ to V^+		14.5	40	μA
		Input Bias Current Match (Channel-to-Channel) (Note 10)	$V_{\text{CM}} = V^+$ $V_{\text{CM}} = V^- + 0.2\text{V}$		0.1 0.4	5 10
I_{OS}	Input Offset Current	$V_{\text{CM}} = V^+$		0.05	2	μA
		$V_{\text{CM}} = V^- + 0.2\text{V}$		0.40	5	μA
ΔI_{OS}	Input Offset Current Shift	$V_{\text{CM}} = V^- + 0.2\text{V}$ to V^+		0.45	7	μA
e_n	Input Noise Voltage Density	$f = 10\text{kHz}$		16		nV/ $\sqrt{\text{Hz}}$
i_n	Input Noise Current Density	$f = 10\text{kHz}$		5		pA/ $\sqrt{\text{Hz}}$
C_{IN}	Input Capacitance	$f = 100\text{kHz}$		2		pF
A_{VOL}	Large-Signal Voltage Gain	$V_O = -4\text{V}$ to 4V , $R_L = 1\text{k}$	30	100		V/mV
		$V_O = -2.5\text{V}$ to 2.5V , $R_L = 100\Omega$	4.5	12		V/mV
CMRR	Common Mode Rejection Ratio	$V_{\text{CM}} = V^-$ to V^+	70	89		dB
		CMRR Match (Channel-to-Channel) (Note 10)	64	89		dB
	Input Common Mode Range		V^-		V^+	V
PSRR	Power Supply Rejection Ratio	$V^+ = 2.5\text{V}$ to 10V , $V^- = 0\text{V}$	71	87		dB
		PSRR Match (Channel-to-Channel) (Note 10)	65	90		dB
V_{OL}	Output Voltage Swing LOW (Note 7)	No Load		12	60	mV
		$I_{\text{SINK}} = 5\text{mA}$		50	140	mV
		$I_{\text{SINK}} = 25\text{mA}$		180	425	mV
V_{OH}	Output Voltage Swing HIGH (Note 7)	No Load		35	100	mV
		$I_{\text{SOURCE}} = 5\text{mA}$		90	200	mV
		$I_{\text{SOURCE}} = 25\text{mA}$		310	700	mV

ELECTRICAL CHARACTERISTICS

$T_A = 25^\circ\text{C}$. $V_S = \pm 5\text{V}$, $V_{\overline{\text{SHDN}}} = \text{open}$, $V_{\text{CM}} = 0\text{V}$, $V_{\text{OUT}} = 0$, unless otherwise noted.

SYMBOL	PARAMETER	CONDITIONS	MIN	TYP	MAX	UNITS
I_{SC}	Short-Circuit Current		± 55	± 85		mA
I_S	Supply Current per Amplifier			15	20	mA
	Supply Current, Shutdown	$V_{\overline{\text{SHDN}}} = 0.3\text{V}$		0.6	1.3	mA
$I_{\overline{\text{SHDN}}}$	$\overline{\text{SHDN}}$ Pin Current	$V_{\overline{\text{SHDN}}} = 0.3\text{V}$		420	750	μA
	Output Leakage Current, Shutdown	$V_{\overline{\text{SHDN}}} = 0.3\text{V}$		0.1	75	μA
V_L	$\overline{\text{SHDN}}$ Pin Input Voltage Low				0.3	V
V_H	$\overline{\text{SHDN}}$ Pin Input Voltage High		$V^+ - 0.5$			V
t_{ON}	Turn-On Time	$V_{\overline{\text{SHDN}}} = 0.3\text{V}$ to 4.5V , $R_L = 100$		80		ns
t_{OFF}	Turn-Off Time	$V_{\overline{\text{SHDN}}} = 4.5\text{V}$ to 0.3V , $R_L = 100$		50		ns
GBW	Gain-Bandwidth Product	Frequency = 2MHz	110	180		MHz
SR	Slew Rate	$A_V = -1$, $R_L = 1\text{k}$, $V_O = \pm 4\text{V}$, Measured at $V_O = \pm 3\text{V}$	175	350		V/ μs
FPBW	Full Power Bandwidth	$V_{\text{OUT}} = 8V_{\text{P-P}}$		14		MHz
THD	Total Harmonic Distortion	$A_V = 1$, $R_L = 1\text{k}$, $V_O = 2V_{\text{P-P}}$, $f_C = 5\text{MHz}$		-90		dB
t_S	Settling Time	0.1%, $V_{\text{STEP}} = 8\text{V}$, $A_V = -1$, $R_L = 500\Omega$		34		ns
ΔG	Differential Gain (NTSC)	$A_V = 2$, $R_L = 150\Omega$		0.01		%
$\Delta\theta$	Differential Phase (NTSC)	$A_V = 2$, $R_L = 150\Omega$		0.01		Deg

The ● denotes the specifications which apply over the $0^\circ\text{C} \leq T_A \leq 70^\circ\text{C}$ temperature range. $V_S = \pm 5\text{V}$, $V_{\overline{\text{SHDN}}} = \text{open}$, $V_{\text{CM}} = 0\text{V}$, $V_{\text{OUT}} = 0\text{V}$, unless otherwise noted.

SYMBOL	PARAMETER	CONDITIONS	MIN	TYP	MAX	UNITS
V_{OS}	Input Offset Voltage	$V_{\text{CM}} = V^+$ LT1809 SO-8	●	1	3.25	mV
		$V_{\text{CM}} = V^-$ LT1809 SO-8	●	1	3.25	mV
		$V_{\text{CM}} = V^+$	●	1	3.75	mV
		$V_{\text{CM}} = V^-$	●	1	3.75	mV
$V_{\text{OS TC}}$	Input Offset Voltage Drift (Note 8)	$V_{\text{CM}} = V^+$	●	10	25	$\mu\text{V}/^\circ\text{C}$
		$V_{\text{CM}} = V^-$	●	10	25	$\mu\text{V}/^\circ\text{C}$
ΔV_{OS}	Input Offset Voltage Shift	$V_{\text{CM}} = V^-$ to V^+ LT1809 SO-8	●	0.5	2.75	mV
		$V_{\text{CM}} = V^-$ to V^+	●	0.5	3.25	mV
	Input Offset Voltage Match (Channel-to-Channel) (Note 10)	$V_{\text{CM}} = V^-$ to V^+	●	1.2	6.5	mV
I_B	Input Bias Current	$V_{\text{CM}} = V^+ - 0.2\text{V}$	●	2.5	12.5	μA
		$V_{\text{CM}} = V^- + 0.4\text{V}$	●	-37.5	-15	μA
ΔI_B	Input Bias Current Shift	$V_{\text{CM}} = V^- + 0.4\text{V}$ to $V^+ - 0.2\text{V}$	●	17.5	50	μA
		Input Bias Current Match (Channel-to-Channel) (Note 10)	$V_{\text{CM}} = V^+ - 0.2\text{V}$	●	0.1	6
		$V_{\text{CM}} = V^- + 0.4\text{V}$	●	0.5	12	μA
I_{OS}	Input Offset Current	$V_{\text{CM}} = V^+ - 0.2\text{V}$	●	0.06	2.25	μA
		$V_{\text{CM}} = V^- + 0.4\text{V}$	●	0.5	6	μA
ΔI_{OS}	Input Offset Current Shift	$V_{\text{CM}} = V^- + 0.4\text{V}$ to $V^+ - 0.2\text{V}$	●	0.56	8.25	μA
A_{VOL}	Large-Signal Voltage Gain	$V_O = -4\text{V}$ to 4V , $R_L = 1\text{k}$	●	27	80	V/mV
		$V_O = -2.5\text{V}$ to 2.5V , $R_L = 100\Omega$	●	3.5	10	V/mV
CMRR	Common Mode Rejection Ratio	$V_{\text{CM}} = V^-$ to V^+	●	69	86	dB
		CMRR Match (Channel-to-Channel) (Note 10)	$V_{\text{CM}} = V^-$ to V^+	●	63	86
	Input Common Mode Range		●	V^-	V^+	V

ELECTRICAL CHARACTERISTICS

The ● denotes the specifications which apply over the 0°C ≤ T_A ≤ 70°C temperature range. V_S = ±5V, V_{SHDN} = open, V_{CM} = 0V, V_{OUT} = 0V, unless otherwise noted.

SYMBOL	PARAMETER	CONDITIONS	MIN	TYP	MAX	UNITS
PSRR	Power Supply Rejection Ratio	V ⁺ = 2.5V to 10V, V ⁻ = 0V	●	70	83	dB
	PSRR Match (Channel-to-Channel) (Note 10)	V ⁺ = 2.5V to 10V, V ⁻ = 0V	●	64	83	dB
V _{OL}	Output Voltage Swing LOW (Note 7)	No Load	●	20	80	mV
		I _{SINK} = 5mA	●	50	160	mV
		I _{SINK} = 25mA	●	210	475	mV
V _{OH}	Output Voltage Swing HIGH (Note 7)	No Load	●	60	140	mV
		I _{SOURCE} = 5mA	●	120	240	mV
		I _{SOURCE} = 25mA	●	370	750	mV
I _{SC}	Short-Circuit Current		●	±45	±75	mA
I _S	Supply Current per Amplifier		●	17.5	25	mA
	Supply Current, Shutdown	V _{SHDN} = 0.3V	●	0.6	1.5	mA
I _{SHDN}	SHDN Pin Current	V _{SHDN} = 0.3V	●	420	850	μA
	Output Leakage Current, Shutdown	V _{SHDN} = 0.3V	●	3		μA
V _L	SHDN Pin Input Voltage Low		●		0.3	V
V _H	SHDN Pin Input Voltage High		●	V ⁺ - 0.5		V
t _{ON}	Turn-On Time	V _{SHDN} = 0.3V to 4.5V, R _L = 100	●	80		ns
t _{OFF}	Turn-Off Time	V _{SHDN} = 4.5V to 0.3V, R _L = 100	●	50		ns
GBW	Gain-Bandwidth Product	Frequency = 2MHz	●	85	170	MHz
SR	Slew Rate	A _V = -1, R _L = 1k, V _O = ±4V, Measured at V _O = ±3V	●	140	300	V/μs
FPBW	Full Power Bandwidth	V _{OUT} = 8V _{P-P}	●	12		MHz

The ● denotes the specifications which apply over the -40°C ≤ T_A ≤ 85°C temperature range. V_S = ±5V, V_{SHDN} = open, V_{CM} = 0V, V_{OUT} = 0V, unless otherwise noted. (Note 5)

SYMBOL	PARAMETER	CONDITIONS	MIN	TYP	MAX	UNITS
V _{OS}	Input Offset Voltage	V _{CM} = V ⁺ LT1809 SO-8	●	1	3.75	mV
		V _{CM} = V ⁻ LT1809 SO-8	●	1	3.75	mV
		V _{CM} = V ⁺	●	1	4.25	mV
		V _{CM} = V ⁻	●	1	4.25	mV
V _{OS} TC	Input Offset Voltage Drift (Note 8)	V _{CM} = V ⁺	●	10	25	μV/°C
		V _{CM} = V ⁻	●	10	25	μV/°C
ΔV _{OS}	Input Offset Voltage Shift	V _{CM} = V ⁻ to V ⁺ LT1809 SO-8	●	0.5	3.00	mV
		V _{CM} = V ⁻ to V ⁺	●	0.5	3.75	mV
	Input Offset Voltage Match (Channel-to-Channel) (Note 10)	V _{CM} = V ⁻ to V ⁺	●	1.2	7.5	mV
I _B	Input Bias Current	V _{CM} = V ⁺ - 0.2V	●	2.8	14	μA
		V _{CM} = V ⁻ + 0.4V	●	-45	-17	μA
ΔI _B	Input Bias Current Shift	V _{CM} = V ⁻ + 0.4V to V ⁺ - 0.2V	●	19.8	59	μA
	Input Bias Current Match (Channel-to-Channel) (Note 10)	V _{CM} = V ⁺ - 0.2V	●	0.1	7	μA
		V _{CM} = V ⁻ + 0.4V	●	0.6	14	μA
I _{OS}	Input Offset Current	V _{CM} = V ⁺ - 0.2V	●	0.08	2.5	μA
		V _{CM} = V ⁻ + 0.4V	●	0.6	8	μA
ΔI _{OS}	Input Offset Current Shift	V _{CM} = V ⁻ + 0.4V to V ⁺ - 0.2V	●	0.68	10.5	μA
A _{VOL}	Large-Signal Voltage Gain	V _O = -4V to 4V, R _L = 1k	●	22	70	V/mV
		V _O = -2.5V to 2.5V, R _L = 100Ω	●	3	10	V/mV

ELECTRICAL CHARACTERISTICS The ● denotes the specifications which apply over the $-40^{\circ}\text{C} \leq T_A \leq 85^{\circ}\text{C}$ temperature range. $V_S = \pm 5\text{V}$, $V_{\text{SHDN}} = \text{open}$, $V_{\text{CM}} = 0\text{V}$, $V_{\text{OUT}} = 0\text{V}$, unless otherwise noted. (Note 5)

SYMBOL	PARAMETER	CONDITIONS	MIN	TYP	MAX	UNITS
CMRR	Common Mode Rejection Ratio	$V_{\text{CM}} = V^- \text{ to } V^+$	● 68	86		dB
	CMRR Match (Channel-to-Channel) (Note 10)	$V_{\text{CM}} = V^- \text{ to } V^+$	● 62	86		dB
	Input Common Mode Range		● V^-		V^+	V
PSRR	Power Supply Rejection Ratio	$V^+ = 2.5\text{V to } 10\text{V}$, $V^- = 0\text{V}$	● 69	83		dB
	PSRR Match (Channel-to-Channel) (Note 10)	$V^+ = 2.5\text{V to } 10\text{V}$, $V^- = 0\text{V}$	● 63	83		dB
V_{OL}	Output Voltage Swing LOW (Note 7)	No Load	●	23	100	mV
		$I_{\text{SINK}} = 5\text{mA}$	●	60	170	mV
		$I_{\text{SINK}} = 25\text{mA}$	●	220	525	mV
V_{OH}	Output Voltage Swing HIGH (Note 7)	No Load	●	75	160	mV
		$I_{\text{SOURCE}} = 5\text{mA}$	●	130	260	mV
		$I_{\text{SOURCE}} = 25\text{mA}$	●	375	775	mV
I_{SC}	Short-Circuit Current		● ± 30	± 75		mA
I_{S}	Supply Current per Amplifier		●	19	25	mA
	Supply Current, Shutdown	$V_{\text{SHDN}} = 0.3\text{V}$	●	0.65	1.6	mA
I_{SHDN}	SHDN Pin Current	$V_{\text{SHDN}} = 0.3\text{V}$	●	420	900	μA
	Output Leakage Current, Shutdown	$V_{\text{SHDN}} = 0.3\text{V}$	●	4		μA
V_{L}	SHDN Pin Input Voltage Low		●		0.3	V
V_{H}	SHDN Pin Input Voltage High		● $V^+ - 0.5$			V
t_{ON}	Turn-On Time	$V_{\text{SHDN}} = 0.3\text{V to } 4.5\text{V}$, $R_{\text{L}} = 100$	●	80		ns
t_{OFF}	Turn-Off Time	$V_{\text{SHDN}} = 4.5\text{V to } 0.3\text{V}$, $R_{\text{L}} = 100$	●	50		ns
GBW	Gain-Bandwidth Product	Frequency = 2MHz	● 80	160		MHz
SR	Slew Rate	$A_{\text{V}} = -1$, $R_{\text{L}} = 1\text{k}$, $V_{\text{O}} = \pm 4\text{V}$, Measured at $V_{\text{O}} = \pm 3\text{V}$	● 110	220		$\text{V}/\mu\text{s}$
FPBW	Full Power Bandwidth	$V_{\text{OUT}} = 8V_{\text{P-P}}$	●	8.5		MHz

Note 1: Absolute Maximum Ratings are those values beyond which the life of a device may be impaired.

Note 2: The inputs are protected by back-to-back diodes. If the differential input voltage exceeds 1.4V, the input current should be limited to less than 10mA.

Note 3: A heat sink may be required to keep the junction temperature below the absolute maximum rating when the output is shorted indefinitely.

Note 4: The LT1809C/LT1809I and LT1810C/LT1810I are guaranteed functional over the operating temperature range of -40°C and 85°C .

Note 5: The LT1809C/LT1810C are guaranteed to meet specified performance from 0°C to 70°C . The LT1809C/LT1810C are designed, characterized and expected to meet specified performance from -40°C to 85°C but are not tested or QA sampled at these temperatures. The LT1809I/LT1810I are guaranteed to meet specified performance from -40°C to 85°C .

Note 6: Minimum supply voltage is guaranteed by power supply rejection ratio test.

Note 7: Output voltage swings are measured between the output and power supply rails.

Note 8: This parameter is not 100% tested.

Note 9: Thermal resistance varies depending upon the amount of PC board metal attached to the V^- pin of the device. θ_{JA} is specified for a certain amount of 2oz of copper metal trace connecting to the V^- pin as described in the thermal resistance tables in the Applications Information section.

Note 10: Matching parameters are the difference between the two amplifiers of the LT1810.

TYPICAL PERFORMANCE CHARACTERISTICS

V_{OS} Distribution, $V_{CM} = 0V$ (PNP Stage)

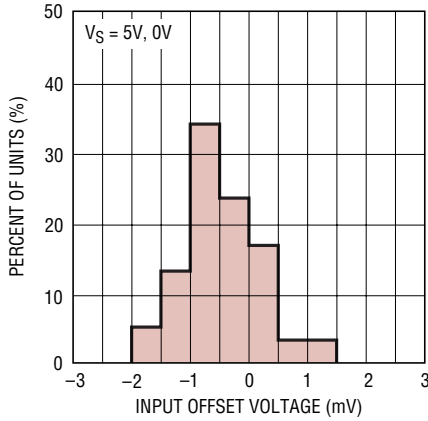

1809 G01

V_{OS} Distribution, $V_{CM} = 5V$ (NPN Stage)

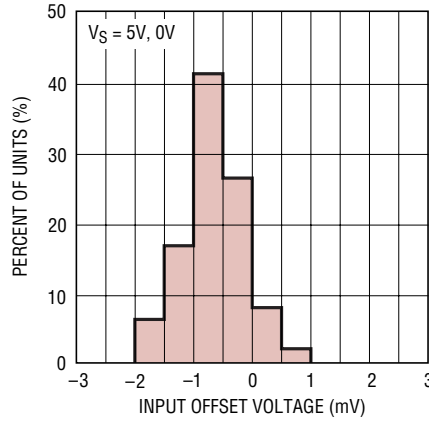

1809 G02

ΔV_{OS} Shift for $V_{CM} = 0V$ to $5V$

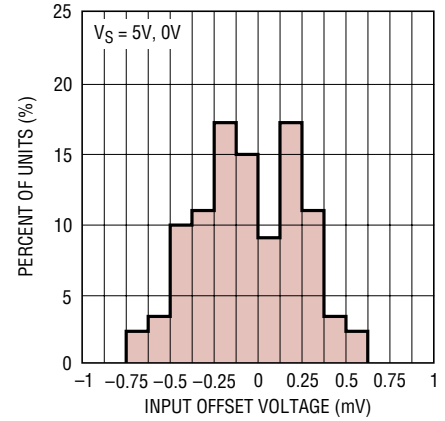

1809 G03

Supply Current vs Supply Voltage

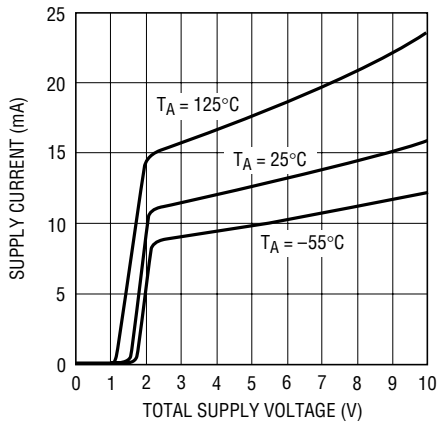

1809 G04

Offset Voltage vs Input Common Mode

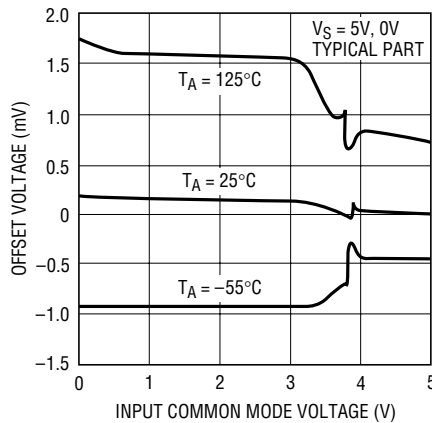

1809 G05

Input Bias Current vs Common Mode Voltage

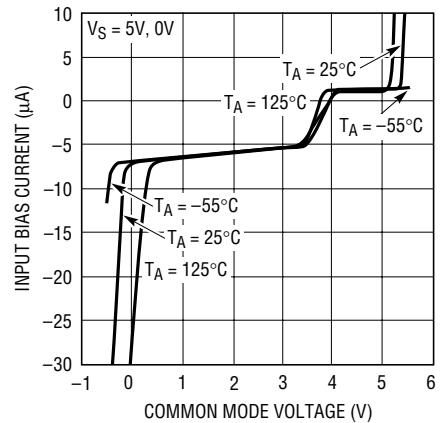

1809 G06

Input Bias Current vs Temperature

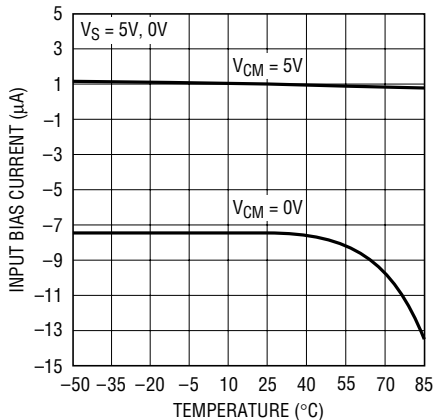

1809 G07

Output Saturation Voltage vs Load Current (Output Low)

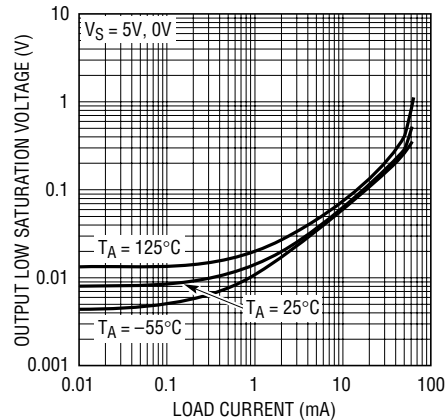

1809 G08

Output Saturation Voltage vs Load Current (Output High)

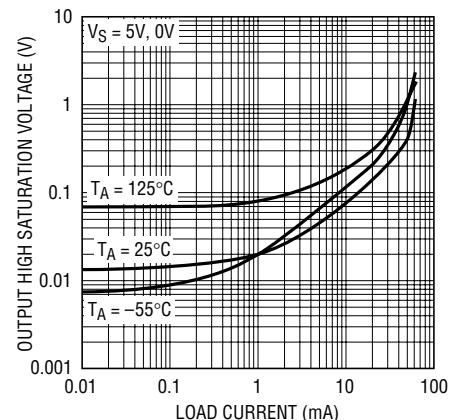

1809 G09

TYPICAL PERFORMANCE CHARACTERISTICS

Minimum Supply Voltage

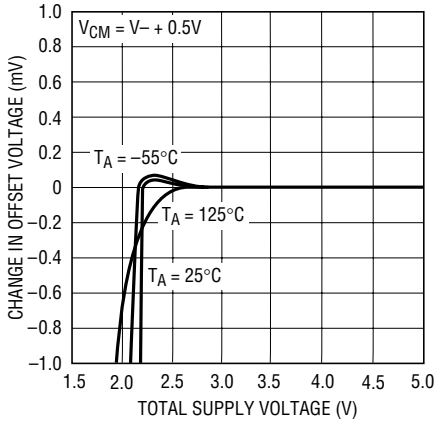

1809 G10

Output Short-Circuit Current vs Power Supply Voltage

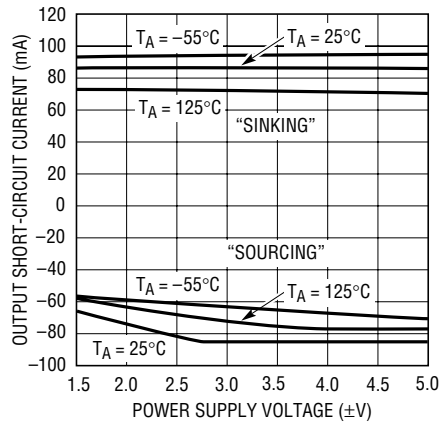

1809 G11

Supply Current vs SHDN Pin Voltage

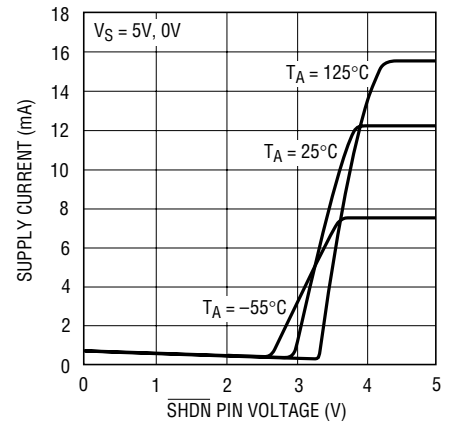

1809 G12

SHDN Pin Current vs SHDN Pin Voltage

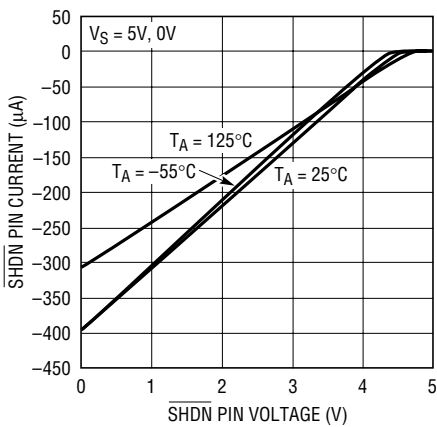

1809 G13

Open-Loop Gain

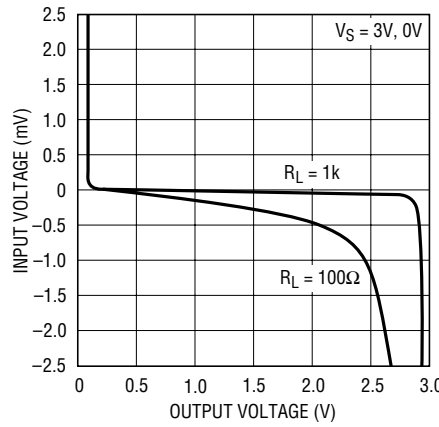

1809 G14

Open-Loop Gain

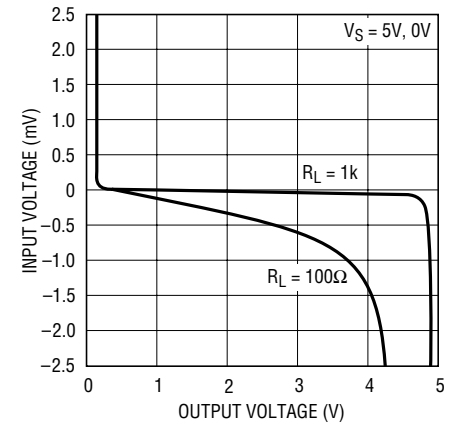

1809 G15

Open-Loop Gain

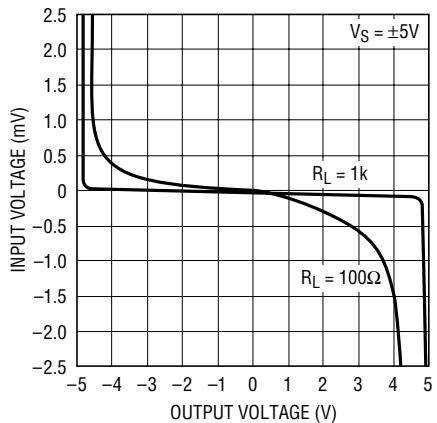

1809 G16

Offset Voltage vs Output Current

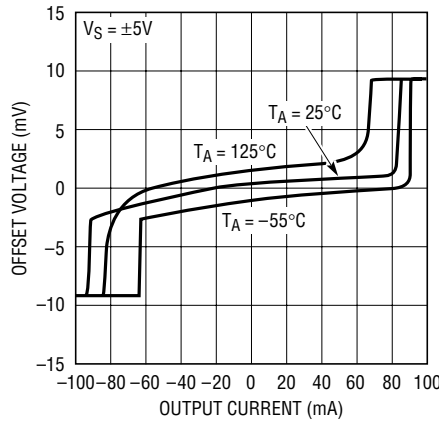

1809 G17

Warm-Up Drift vs Time (LT1809S8)

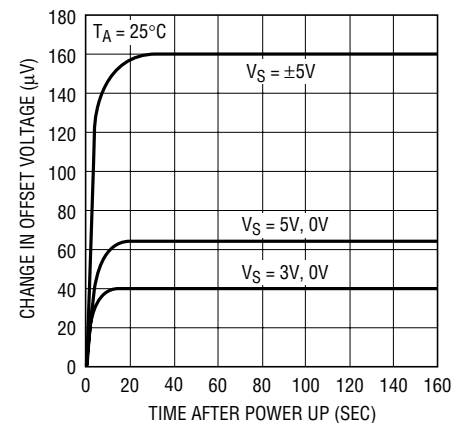

1809 G18

TYPICAL PERFORMANCE CHARACTERISTICS

Input Noise Voltage vs Frequency

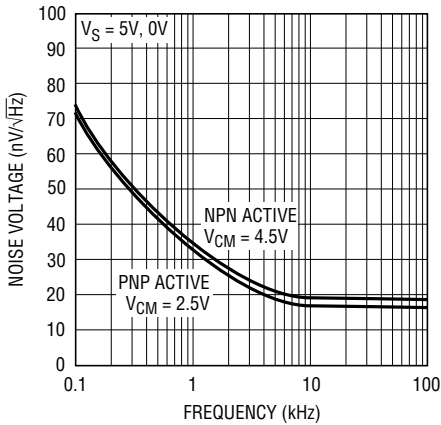

1809 G19

Input Noise Current vs Frequency

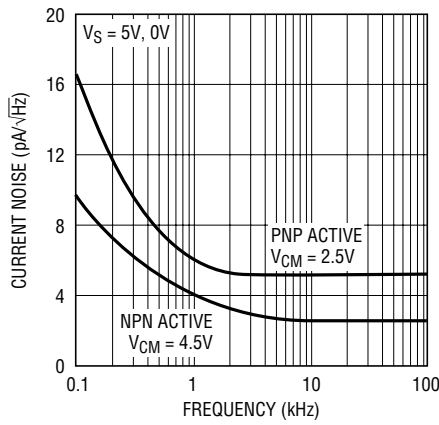

1809 G20

0.1Hz to 10Hz Output Voltage Noise

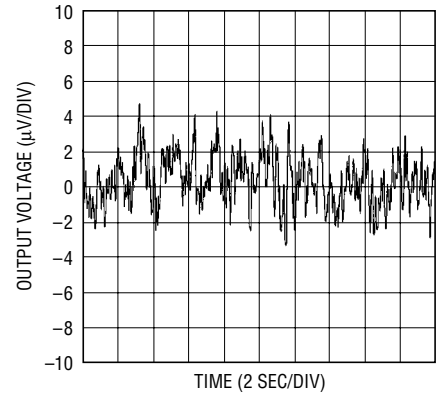

1809 G21

Gain Bandwidth and Phase Margin vs Supply Voltage

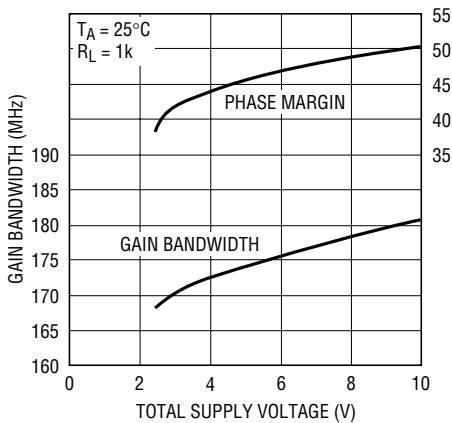

1809 G23

Gain Bandwidth and Phase Margin vs Temperature

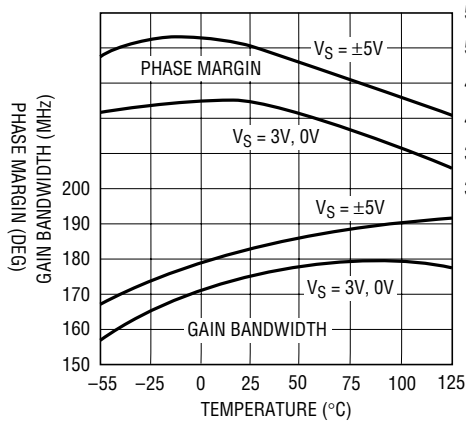

1809 G24

Slew Rate vs Temperature

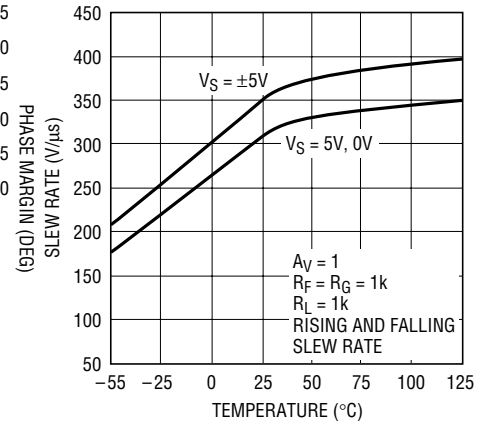

1809 G25

Gain and Phase vs Frequency

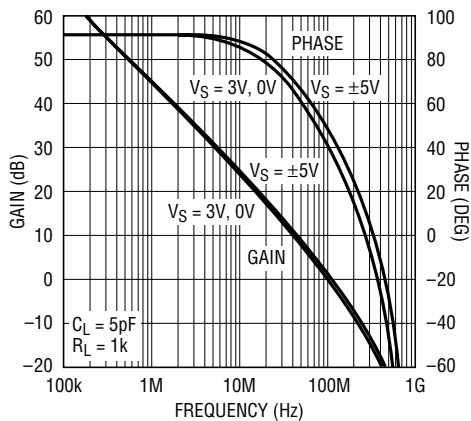

1809 G22

Closed-Loop Gain vs Frequency

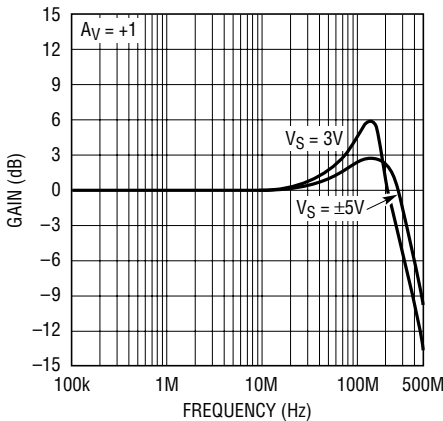

1809 G26

Closed-Loop Gain vs Frequency

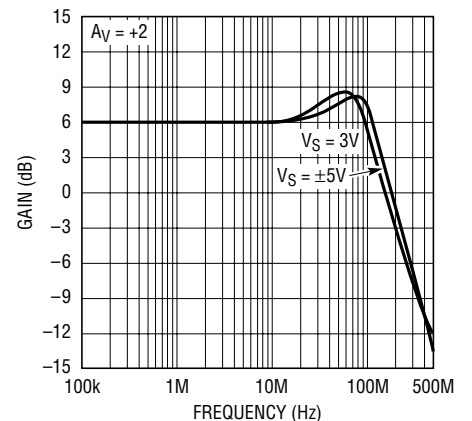

1809 G27

TYPICAL PERFORMANCE CHARACTERISTICS

Output Impedance vs Frequency

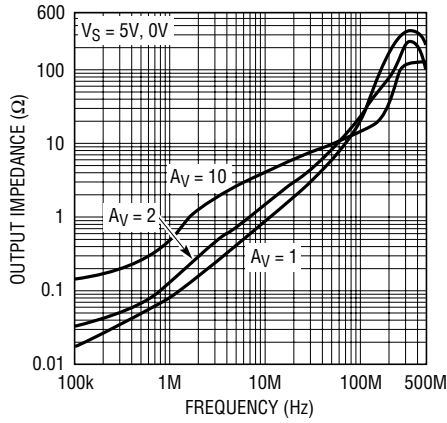

1809 G28

Common Mode Rejection Ratio vs Frequency

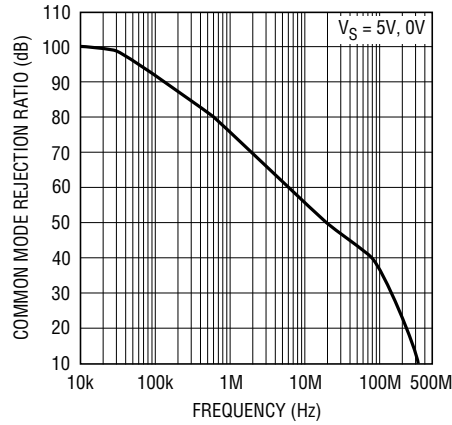

1809 G30

Power Supply Rejection Ratio vs Frequency

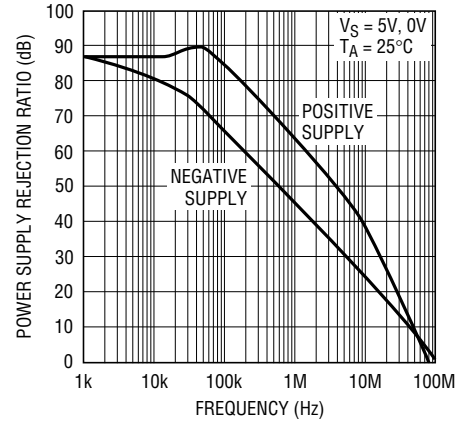

1809 G31

Series Output Resistor vs Capacitive Load

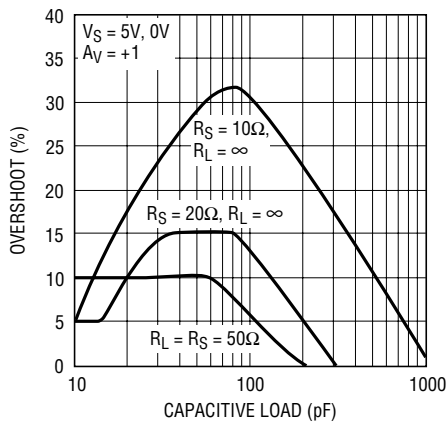

1809 G32

Series Output Resistor vs Capacitive Load

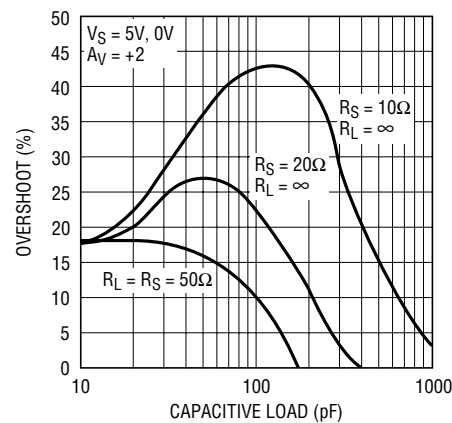

1809 G33

0.01% Settling Time

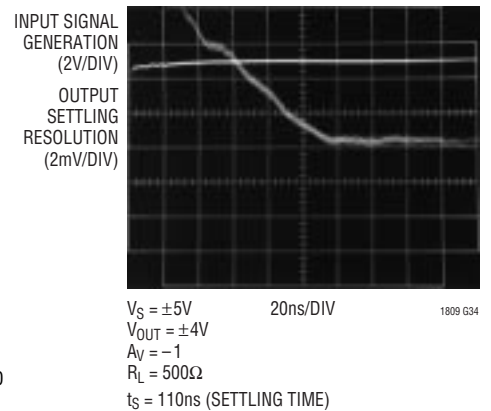

1809 G34

Distortion vs Frequency

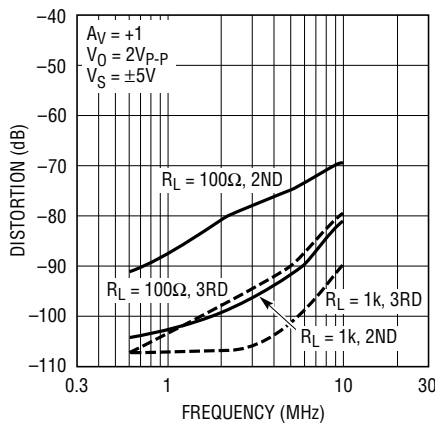

1809 G35

Distortion vs Frequency

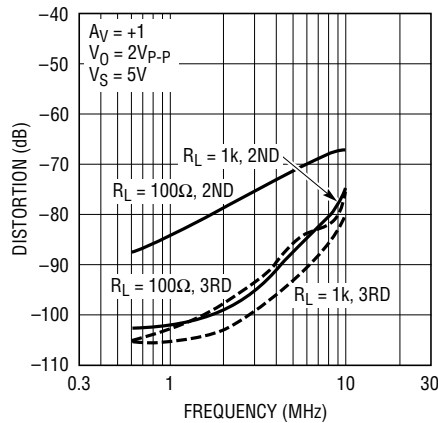

1809 G36

Distortion vs Frequency

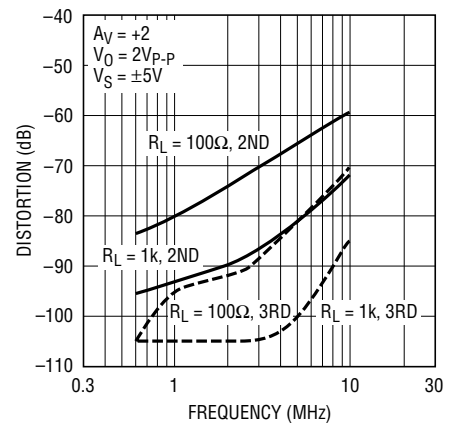

1809 G37

TYPICAL PERFORMANCE CHARACTERISTICS

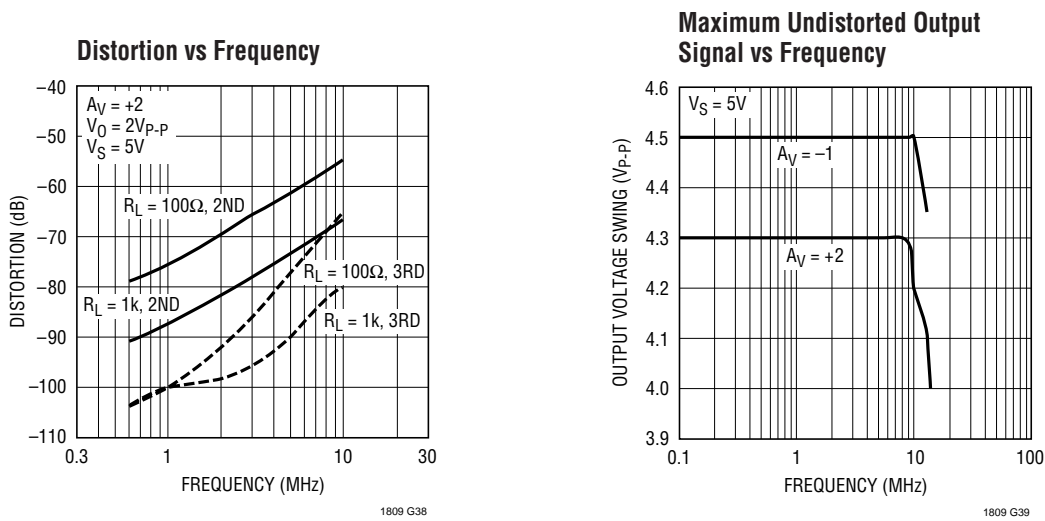

±5V Large-Signal Response

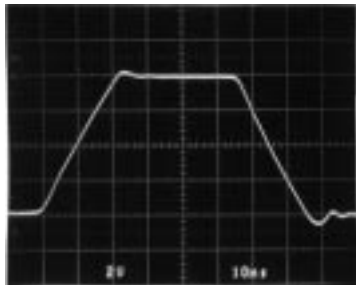

$V_S = \pm 5V$
 $A_V = +1$
 $R_L = 1k$
 10ns/DIV 1809 G40

±5V Small-Signal Response

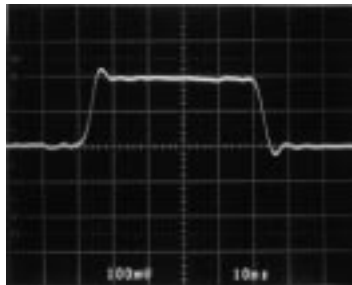

$V_S = \pm 5V$
 $A_V = +1$
 $R_L = 1k$
 10ns/DIV 1809 G41

5V Large-Signal Response

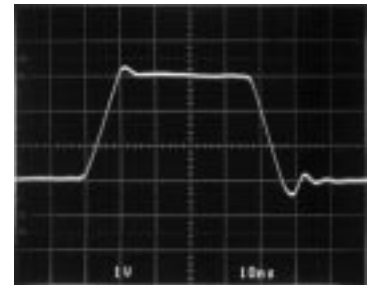

$V_S = 5V$
 $A_V = +1$
 $R_L = 1k$
 10ns/DIV 1809 G42

5V Small-Signal Response

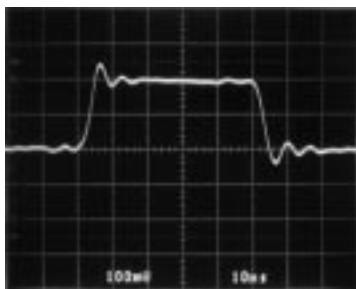

$V_S = 5V$
 $A_V = +1$
 $R_L = 1k$
 10ns/DIV 1809 G43

Output Overdriven Recovery

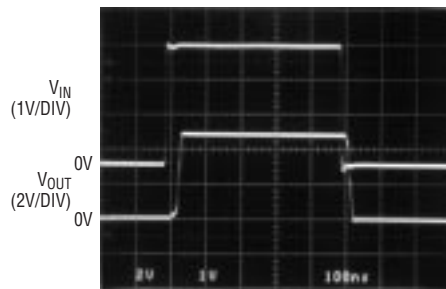

$V_S = 5V, 0V$
 $A_V = +2$
 100ns/DIV 1809 G44

Shutdown Response

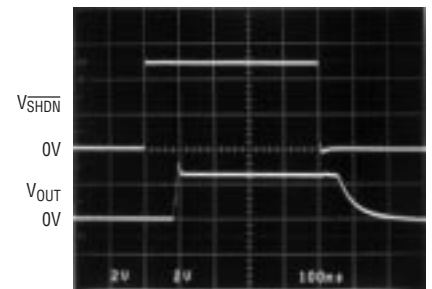

$V_S = 5V, 0V$
 $A_V = +2$
 $R_L = 100\Omega$
 100ns/DIV 1809 G44

APPLICATIONS INFORMATION

Rail-to-Rail Characteristics

The LT1809/LT1810 have an input and output signal range that includes both negative and positive power supply. Figure 1 depicts a simplified schematic of the amplifier. The input stage is comprised of two differential amplifiers, a PNP stage Q1/Q2 and a NPN stage Q3/Q4 that are active over different ranges of common mode input voltage. The PNP differential pair is active for common mode voltages between the negative supply to approximately 1.5V below the positive supply. As the input voltage moves closer toward the positive supply, the transistor Q5 will steer the tail current I_1 to the current mirror Q6/Q7, activating the NPN differential pair and causing the PNP pair to become inactive for the rest of the input common mode range up to the positive supply.

A pair of complementary common emitter stages Q14/Q15 form the output stage, enabling the output to swing from rail-to-rail. The capacitors C1 and C2 form the local feedback loops that lower the output impedance at high frequency. These devices are fabricated on Linear Technology's proprietary high speed complementary bipolar process.

Power Dissipation

The LT1809/LT1810 amplifiers combine high speed with large output current in a small package, so there is a need to ensure that the die's junction temperature does not exceed 150°C. The LT1809 is housed in an SO-8 package or a 6-lead SOT-23 package and the LT1810 is in an SO-8 or 8-lead MSOP package. All packages have the V^- supply pin fused to the lead frame to enhance the thermal conductance when connecting to a ground plane or a large metal trace. Metal trace and plated through-holes can be used to spread the heat generated by the device to the backside of the PC board. For example, on a 3/32" FR-4 board with 2oz copper, a total of 660 square millimeters connected to Pin 4 of LT1810 in an SO-8 package (330 square millimeters on each side of the PC board) will bring the thermal resistance, θ_{JA} , to about 85°C/W. Without extra metal trace connected to the V^- pin to provide a heat sink, the thermal resistance will be around 105°C/W. More information on thermal resistance for all packages with various metal areas connecting to the V^- pin is provided in Tables 1, 2 and 3 for thermal consideration.

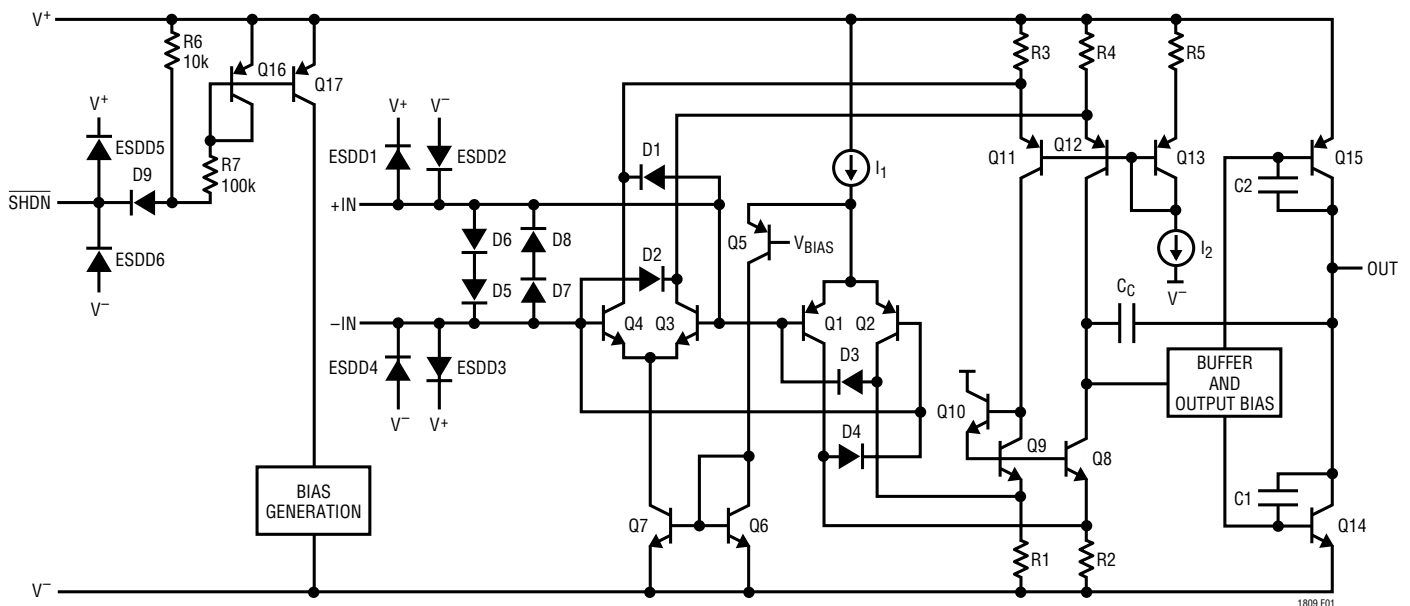

Figure 1. LT1809 Simplified Schematic Diagram

APPLICATIONS INFORMATION

Table 1. LT1809 6-Lead SOT-23 Package

COPPER AREA		BOARD AREA (mm ²)	THERMAL RESISTANCE (JUNCTION-TO-AMBIENT)
TOPSIDE (mm ²)	BACKSIDE (mm ²)		
270		2500	135°C/W
100		2500	145°C/W
20		2500	160°C/W
0		2500	200°C/W

Device is mounted on topside.

Table 2. LT1809/LT1810 SO-8 Package

COPPER AREA		BOARD AREA (mm ²)	THERMAL RESISTANCE (JUNCTION-TO-AMBIENT)
TOPSIDE (mm ²)	BACKSIDE (mm ²)		
1100	1100	2500	65°C/W
330	330	2500	85°C/W
35	35	2500	95°C/W
35	0	2500	100°C/W
0	0	2500	105°C/W

Device is mounted on topside.

Table 3. LT1810 8-Lead MSOP Package

COPPER AREA		BOARD AREA (mm ²)	THERMAL RESISTANCE (JUNCTION-TO-AMBIENT)
TOPSIDE (mm ²)	BACKSIDE (mm ²)		
540	540	2500	110°C/W
100	100	2500	120°C/W
100	0	2500	130°C/W
30	0	2500	135°C/W
0	0	2500	140°C/W

Device is mounted on topside.

Junction temperature T_J is calculated from the ambient temperature T_A and power dissipation P_D as follows:

$$T_J = T_A + (P_D \cdot \theta_{JA})$$

The power dissipation in the IC is the function of the supply voltage, output voltage and the load resistance. For a given supply voltage, the worst-case power dissipation $P_{D(MAX)}$ occurs at the maximum supply current with the output voltage at half of either supply voltage (or the maximum swing is less than 1/2 the supply voltage). $P_{D(MAX)}$ is given by:

$$P_{D(MAX)} = (V_S \cdot I_{S(MAX)}) + (V_S/2)^2/R_L$$

Example: An LT1810 in SO-8 mounted on a 2500mm² area of PC board without any extra heat spreading plane

connected to its V^- pin has a thermal resistance of 105°C/W, θ_{JA} . Operating on $\pm 5V$ supplies with both amplifiers simultaneously driving 50Ω loads, the worst-case power dissipation is given by:

$$\begin{aligned} P_{D(MAX)} &= 2 \cdot (10 \cdot 25mA) + 2 \cdot (2.5)^2/50 \\ &= 0.5 + 0.250 = 0.750W \end{aligned}$$

The maximum ambient temperature that the part is allowed to operate is:

$$\begin{aligned} T_A &= T_J - (P_{D(MAX)} \cdot 105^\circ\text{C/W}) \\ &= 150^\circ\text{C} - (0.750W \cdot 105^\circ\text{C/W}) = 71^\circ\text{C} \end{aligned}$$

To operate the device at higher ambient temperature, connect more metal area to the V^- pin to reduce the thermal resistance of the package as indicated in Table 2.

Input Offset Voltage

The offset voltage will change depending upon which input stage is active and the maximum offset voltage is guaranteed to be less than 3mV. The change of V_{OS} over the entire input common mode range (CMRR) is less than 2.5mV on a single 5V and 3V supply.

Input Bias Current

The input bias current polarity depends upon a given input common voltage at whichever input stage is operating. When the PNP input stage is active, the input bias currents flow out of the input pins and flow into the input pins when the NPN input stage is activated. Because the input offset current is less than the input bias current, matching the source resistances at the input pin will reduce total offset error.

Output

The LT1809/LT1810 can deliver a large output current, so the short-circuit current limit is set around 90mA to prevent damage to the device. Attention must be paid to keep the junction temperature of the IC below the absolute maximum rating of 150°C (refer to the Power Dissipation section) when the output is continuously short circuited. The output of the amplifier has reverse-biased diodes connected to each supply. If the output is forced

APPLICATIONS INFORMATION

beyond either supply, unlimited current will flow through these diodes. If the current is transient and limited to several hundred milliamps, no damage to the device will occur.

Overdrive Protection

When the input voltage exceeds the power supplies, two pairs of crossing diodes, D1 to D4, will prevent the output from reversing polarity. If the input voltage exceeds either power supply by 700mV, diodes D1/D2 or D3/D4 will turn on, keeping the output at the proper polarity. For the phase reversal protection to perform properly, the input current must be limited to less than 5mA. If the amplifier is severely overdriven, an external resistor should be used to limit the overdrive current.

The LT1809/LT1810's input stages are also protected against differential input voltages of 1.4V or higher by back-to-back diodes, D5/D8, that prevent the emitter-base breakdown of the input transistors. The current in these diodes should be limited to less than 10mA when they are active. The worst-case differential input voltage usually occurs when the input is driven while the output is shorted to ground in a unity-gain configuration. In addition, the amplifier is protected against ESD strikes up to 3kV on all pins by a pair of protection diodes on each pin that are connected to the power supplies as shown in Figure 1.

Capacitive Load

The LT1809/LT1810 is optimized for high bandwidth and low distortion applications. It can drive a capacitive load about 20pF in a unity-gain configuration and more with higher gain. When driving a larger capacitive load, a resistor of 10 Ω to 50 Ω should be connected between the

output and the capacitive load to avoid ringing or oscillation. The feedback should still be taken from the output so that the resistor will isolate the capacitive load to ensure stability. Graphs on capacitive loads indicate the transient response of the amplifier when driving capacitive load with a specified series resistor.

Feedback Components

When feedback resistors are used to set up gain, care must be taken to ensure that the pole formed by the feedback resistors and the total capacitance at the inverting input does not degrade stability. For instance, the LT1809 in a noninverting gain of 2, set up with two 1K resistors and a capacitance of 3pF (device plus PC board), will probably ring in transient response. The pole that is formed at 106MHz will reduce phase margin by 34 degrees when the crossover frequency of the amplifier is around 70MHz. A capacitor of 3pF or higher connected across the feedback resistor will eliminate any ringing or oscillation.

$\overline{\text{SHDN}}$ Pin

The LT1809 has a $\overline{\text{SHDN}}$ pin to reduce the supply current to less than 1.25mA. When the $\overline{\text{SHDN}}$ pin is pulled low, it will generate a signal to power down the device. If the pin is left unconnected, an internal pull-up resistor of 10k will keep the part fully operating as shown in Figure 1. The output will be high impedance during shutdown, and the turn-on and turn-off time is less than 100ns. Because the inputs are protected by a pair of back-to-back diodes, the input signal will feed through to the output during shutdown mode if the amplitude of signal between the inputs is larger than 1.4V.

TYPICAL APPLICATIONS

Driving A/D Converters

The LT1809/LT1810 have a 27ns settling time to 0.1% of a 2V step signal and 20Ω output impedance at 100MHz making it ideal for driving high speed A/D converters. With the rail-to-rail input and output and low supply voltage operation, the LT1809 is also desirable for single supply applications. As shown in Figure 2, the LT1809 drives a 10Msps, 12-bit ADC, the LTC1420. The lowpass filter, R3 and C1, reduces the noise and distortion products that might come from the input signal. High quality capacitors

and resistors, an NPO chip capacitor and metal-film surface mount resistors, should be used since these components can add to distortion. The voltage glitch of the converter, due to its sampling nature, is buffered by the LT1809 and the ability of the amplifier to settle it quickly will affect the spurious-free dynamic range of the system. Figure 2 to Figure 7 depict the LT1809 driving the LTC1420 at different configurations and voltage supplies. The FFT responses show better than 90dB of SFDR for a ±5V supply, and 80dB on a 5V single supply for the 1.394MHz signal.

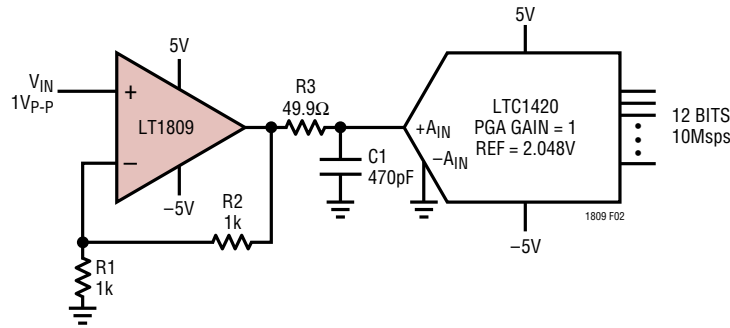

Figure 2. Noninverting A/D Driver

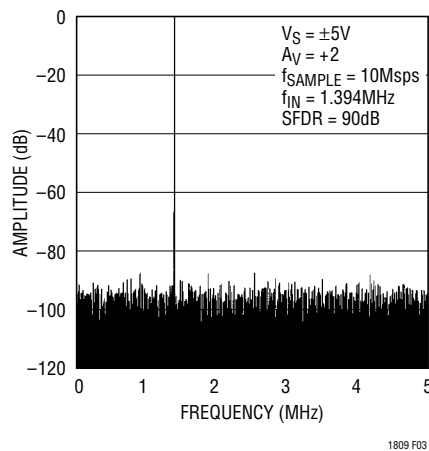

Figure 3. 4096 Point FFT Response

TYPICAL APPLICATIONS

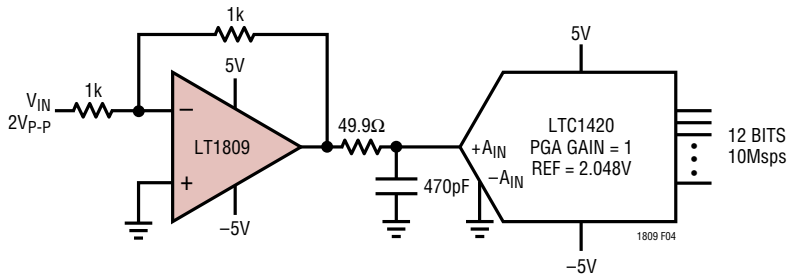

Figure 4. Inverting A/D Driver

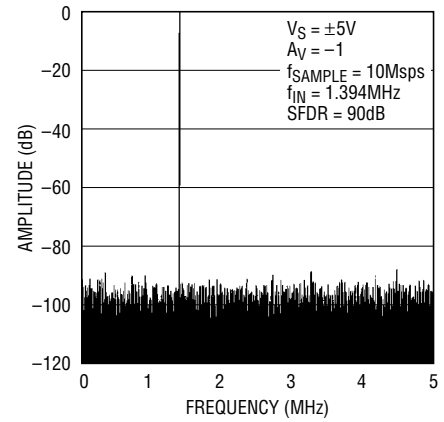

Figure 5. 4096 Point FFT Response

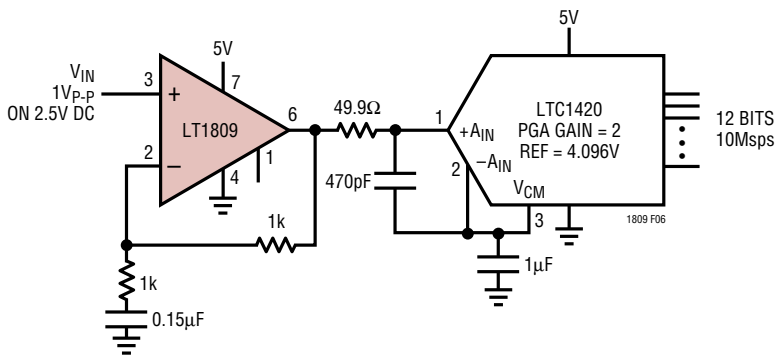

Figure 6. Single Supply A/D Driver

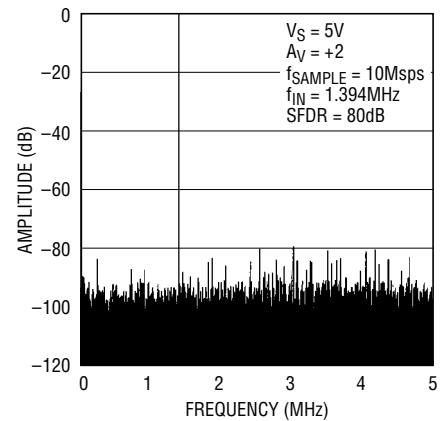

Figure 7. 4096 Point FFT Response

TYPICAL APPLICATIONS

Single Supply Video Line Driver

The LT1809 is a wideband rail-to-rail op amp with a large output current that allows it to drive video signals in low supply applications. Figure 8 depicts a single supply video line driver with AC coupling to minimize the quiescent power dissipation. Resistors R1 and R2 are used to level-shift the input and output to provide the largest signal swing. A gain of 2 is set up with R3 and R4 to restore the signal at V_{OUT} , which is attenuated by 6dB due to the matching of the 75Ω line with the back-terminated

resistor, R5. The back termination will eliminate any reflection of the signal that comes from the load. The input termination resistor, R_T , is optional—it is used only if matching of the incoming line is necessary. The values of C1, C2 and C3 are selected to minimize the droop of the luminance signal. In some less stringent requirements, the value of capacitors could be reduced. The -3dB bandwidth of the driver is about 95MHz on 5V supply and the amount of peaking will vary upon the value of capacitor C4.

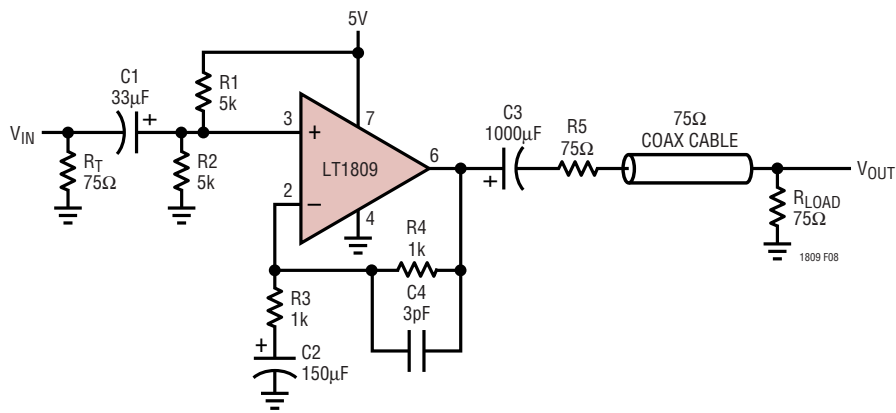

Figure 8. 5V Single Supply Video Line Driver

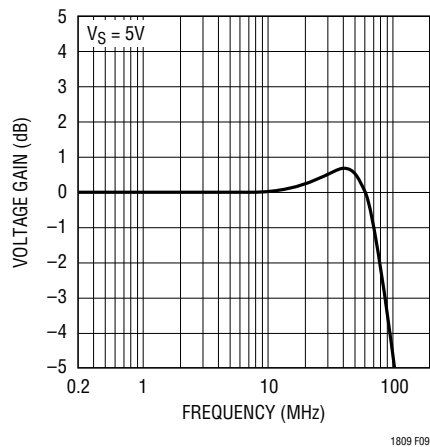

Figure 9. Video Line Driver Frequency Response

PACKAGE DESCRIPTION

Dimensions in inches (millimeters) unless otherwise noted.

**S6 Package
6-Lead Plastic SOT-23**

(Reference LTC DWG # 05-08-1634)

(Reference LTC DWG # 05-08-1636)

	SOT-23 (Original)	SOT-23 (ThinSOT)
A	.90 - 1.45 (.035 - .057)	1.00 MAX (.039 MAX)
A1	.00 - 0.15 (.00 - .006)	.01 - .10 (.0004 - .004)
A2	.90 - 1.30 (.035 - .051)	.80 - .90 (.031 - .035)
L	.35 - .55 (.014 - .021)	.30 - .50 REF (.012 - .019 REF)

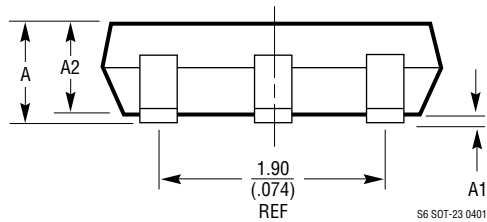
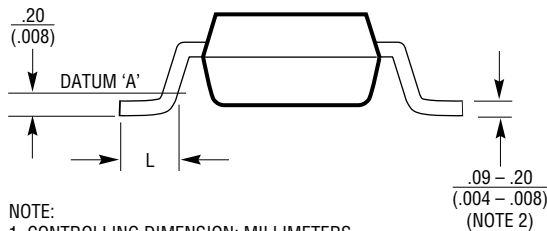
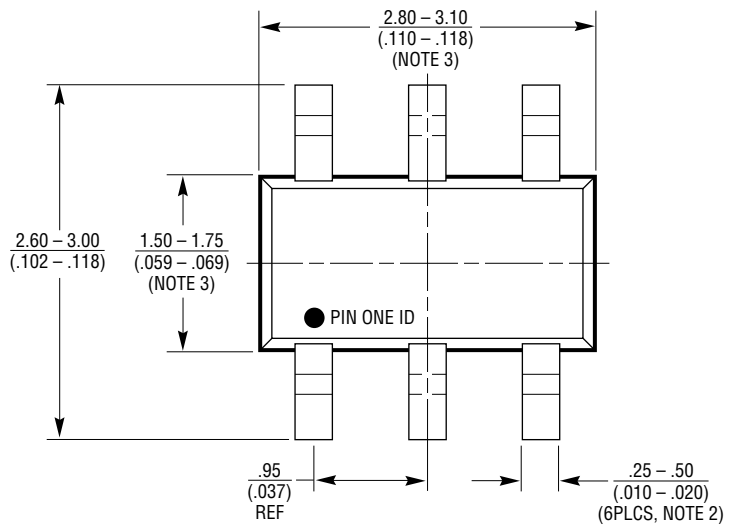

- NOTE:
1. CONTROLLING DIMENSION: MILLIMETERS
 2. DIMENSIONS ARE IN MILLIMETERS (INCHES)
 3. DRAWING NOT TO SCALE
 4. DIMENSIONS ARE INCLUSIVE OF PLATING
 5. DIMENSIONS ARE EXCLUSIVE OF MOLD FLASH AND METAL BURR
 6. MOLD FLASH SHALL NOT EXCEED .254mm
 7. PACKAGE EIAJ REFERENCE IS:
SC-74A (EIAJ) FOR ORIGINAL
JEDEC MO-193 FOR THIN

PACKAGE DESCRIPTION Dimensions in inches (millimeters) unless otherwise noted.

MS8 Package
8-Lead Plastic MSOP
 (Reference LTC DWG # 05-08-1660)

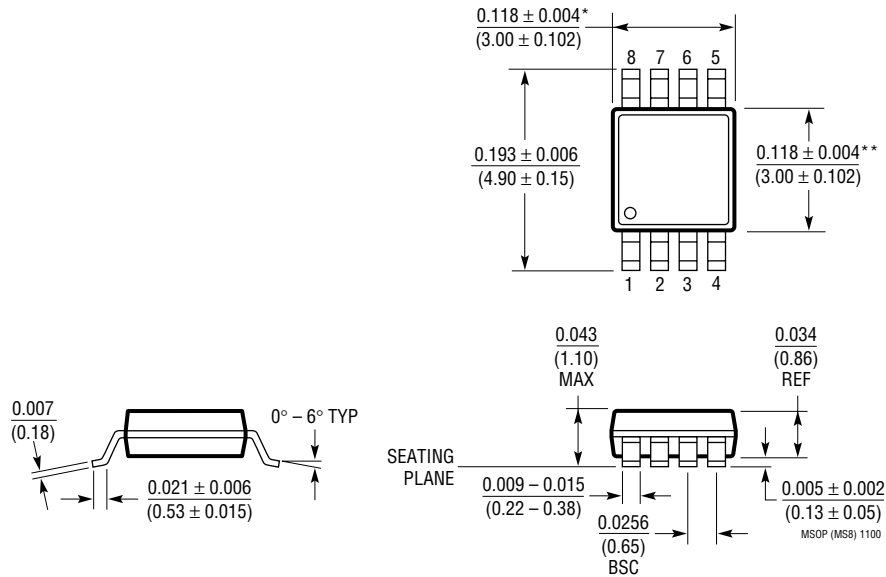

- * DIMENSION DOES NOT INCLUDE MOLD FLASH, PROTRUSIONS OR GATE BURRS. MOLD FLASH, PROTRUSIONS OR GATE BURRS SHALL NOT EXCEED 0.006* (0.152mm) PER SIDE
- ** DIMENSION DOES NOT INCLUDE INTERLEAD FLASH OR PROTRUSIONS. INTERLEAD FLASH OR PROTRUSIONS SHALL NOT EXCEED 0.006* (0.152mm) PER SIDE

PACKAGE DESCRIPTION Dimensions in inches (millimeters) unless otherwise noted.

S8 Package
8-Lead Plastic Small Outline (Narrow .150 Inch)
 (Reference LTC DWG # 05-08-1610)

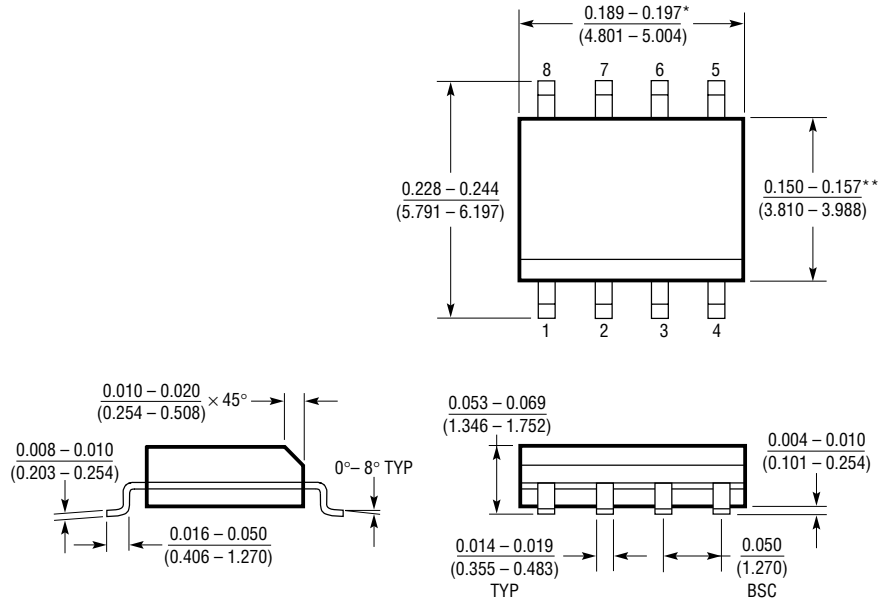

DIMENSION DOES NOT INCLUDE MOLD FLASH. MOLD FLASH SHALL NOT EXCEED 0.006 (0.152mm) PER SIDE
 **DIMENSION DOES NOT INCLUDE INTERLEAD FLASH. INTERLEAD FLASH SHALL NOT EXCEED 0.010* (0.254mm) PER SIDE

S08 1298

TYPICAL APPLICATION

Single 3V Supply, 4MHz, 4th Order Butterworth Filter

Benefiting from a low voltage supply operation, low distortion and rail-to-rail output of LT1809, a low distortion filter that is suitable for antialiasing can be built as

shown Figure 10. On a 3V supply, the filter has a pass-band of 4MHz with 2.5V_{P-P} signal and a stopband that is greater than 70dB to frequency of 100MHz.

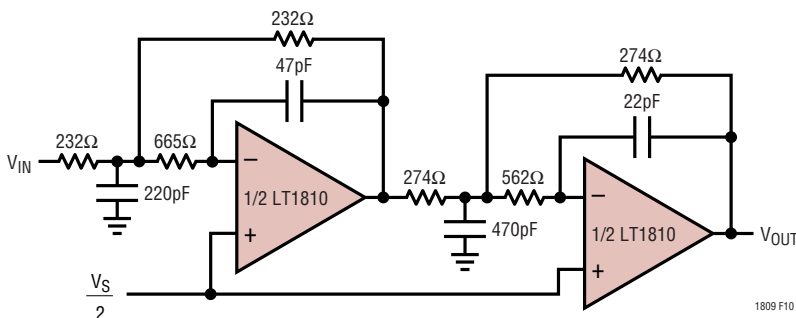

Figure 10. Single 3V Supply, 4MHz, 4th Order Butterworth Filter

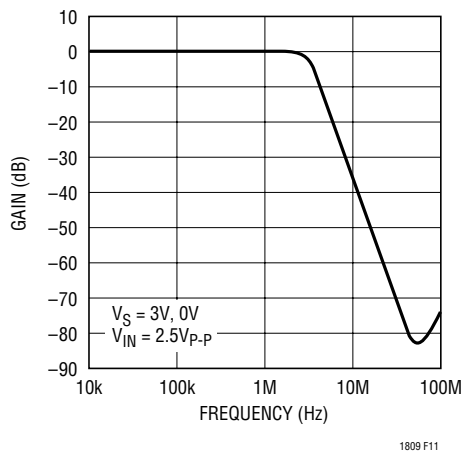

Figure 11. Filter Frequency Response

RELATED PARTS

PART NUMBER	DESCRIPTION	COMMENTS
LT1395	400MHz Current Feedback Amplifier	800V/μs Slew Rate, Shutdown
LT1632/LT1633	Dual/Quad 45MHz, 45V/μs Rail-to-Rail Input and Output Op Amps	High DC Accuracy, 1.35mV V _{OS(MAX)} , 70mA Output Current, Max Supply Current 5.2mA per Amplifier
LT1630/LT1631	Dual/Quad 30MHz, 10V/μs Rail-to-Rail Input and Output Op Amps	High DC Accuracy, 525μV V _{OS(MAX)} , 70mA Output Current, Max Supply Current 4.4mA per Amplifier
LT1806/LT1807	Single/Dual 325MHz, 140V/μs Rail-to-Rail Input and Output Op Amps	High DC Accuracy, 550μV V _{OS(MAX)} , Low Noise 3.5nV/√Hz, Low Distortion -80dBc at 5MHz