

1PS76SB21; BAT721 series

Schottky barrier diodes in small packages

Rev. 06 — 21 December 2006

Product data sheet

1. Product profile

1.1 General description

Planar Schottky barrier diodes with an integrated guard ring for stress protection. Encapsulated in small Surface-Mounted Device (SMD) plastic packages.

Table 1. Product overview

Type number	Package		Configuration
	NXP	JEITA	
1PS76SB21	SOD323	SC-76	single
BAT721	SOT23	-	single
BAT721A	SOT23	-	dual common anode
BAT721C	SOT23	-	dual common cathode
BAT721S	SOT23	-	dual series

1.2 Features

- Low forward voltage
- Small SMD plastic packages
- Low capacitance

1.3 Applications

- Ultra high-speed switching
- Voltage clamping
- Line termination
- Reverse polarity protection

1.4 Quick reference data

Table 2. Quick reference data

Symbol	Parameter	Conditions	Min	Typ	Max	Unit
Per diode						
I_F	forward current		-	-	200	mA
V_R	reverse voltage		-	-	40	V
V_F	forward voltage	$I_F = 200 \text{ mA}$	[1]	-	550	mV

[1] Pulse test: $t_p \leq 300 \mu\text{s}$; $\delta \leq 0.02$.

2. Pinning information

Table 3. Pinning

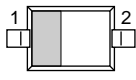
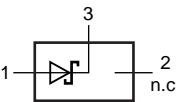
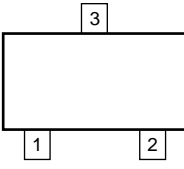
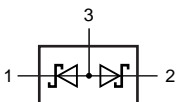
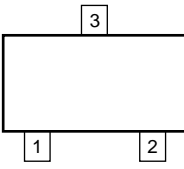
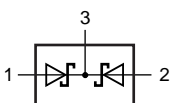
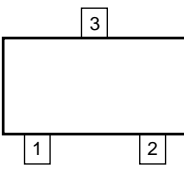
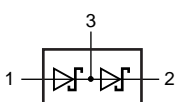
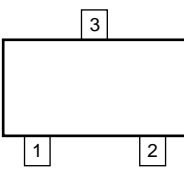
Pin	Description	Simplified outline	Symbol
1PS76SB21			
1	cathode	[1]	
2	anode		<i>sym001</i>
BAT721			
1	anode		
2	not connected		<i>006aaa436</i>
3	cathode		<i>006aaa144</i>
BAT721A			
1	cathode (diode 1)		
2	cathode (diode 2)		<i>006aaa439</i>
3	anode (diode 1), anode (diode 2)		<i>006aaa144</i>
BAT721C			
1	anode (diode 1)		
2	anode (diode 2)		<i>006aaa438</i>
3	cathode (diode 1), cathode (diode 2)		<i>006aaa144</i>
BAT721S			
1	anode (diode 1)		
2	cathode (diode 2)		<i>006aaa437</i>
3	cathode (diode 1), anode (diode 2)		<i>006aaa144</i>

[1] The marking bar indicates the cathode.

3. Ordering information

Table 4. Ordering information

Type number	Package		
	Name	Description	Version
1PS76SB21	SC-76	plastic surface-mounted package; 2 leads	SOD323
BAT721	-	plastic surface-mounted package; 3 leads	SOT23
BAT721A			
BAT721C			
BAT721S			

4. Marking

Table 5. Marking codes

Type number	Marking code ^[1]
1PS76SB21	S1
BAT721	L7*
BAT721A	L8*
BAT721C	L9*
BAT721S	L0*

- [1] * = -: made in Hong Kong
 * = p: made in Hong Kong
 * = t: made in Malaysia
 * = W: made in China

5. Limiting values

Table 6. Limiting values

In accordance with the Absolute Maximum Rating System (IEC 60134).

Symbol	Parameter	Conditions	Min	Max	Unit
Per diode					
V_R	reverse voltage		-	40	V
I_F	forward current		-	200	mA
I_{FSM}	non-repetitive peak forward current	half sine wave; JEDEC method; $t_p = 8.3$ ms	-	1	A
T_j	junction temperature		-	125	°C
T_{amb}	ambient temperature		-65	+150	°C
T_{stg}	storage temperature		-65	+150	°C

6. Thermal characteristics

Table 7. Thermal characteristics

Symbol	Parameter	Conditions	Min	Typ	Max	Unit
Per diode						
$R_{th(j-a)}$	thermal resistance from junction to ambient	in free air	[1]			
	1PS76SB21		-	-	450	K/W
	BAT721		-	-	500	K/W
	BAT721A		-	-	500	K/W
	BAT721C		-	-	500	K/W
	BAT721S		-	-	500	K/W

[1] Device mounted on an FR4 Printed-Circuit Board (PCB), single-sided copper, tin-plated and standard footprint.

7. Characteristics

Table 8. Characteristics

$T_{amb} = 25\text{ }^{\circ}\text{C}$ unless otherwise specified.

Symbol	Parameter	Conditions	Min	Typ	Max	Unit
Per diode						
V_F	forward voltage	$I_F = 10\text{ mA}$	[1]	-	300	mV
		$I_F = 100\text{ mA}$	[1]	-	420	mV
		$I_F = 200\text{ mA}$	[1]	-	550	mV
I_R	reverse current	$V_R = 30\text{ V}$	-	-	15	μA
		$V_R = 30\text{ V}; T_j = 100\text{ }^{\circ}\text{C}$	-	-	3	mA
C_d	diode capacitance	$V_R = 0\text{ V}; f = 1\text{ MHz}$	-	40	50	pF

[1] Pulse test: $t_p \leq 300\text{ }\mu\text{s}$; $\delta \leq 0.02$.

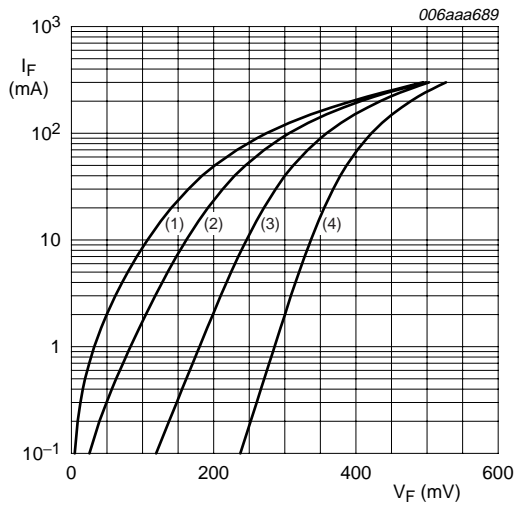

- (1) $T_{\text{amb}} = 125^\circ\text{C}$
- (2) $T_{\text{amb}} = 85^\circ\text{C}$
- (3) $T_{\text{amb}} = 25^\circ\text{C}$
- (4) $T_{\text{amb}} = -40^\circ\text{C}$

Fig 1. Forward current as a function of forward voltage; typical values

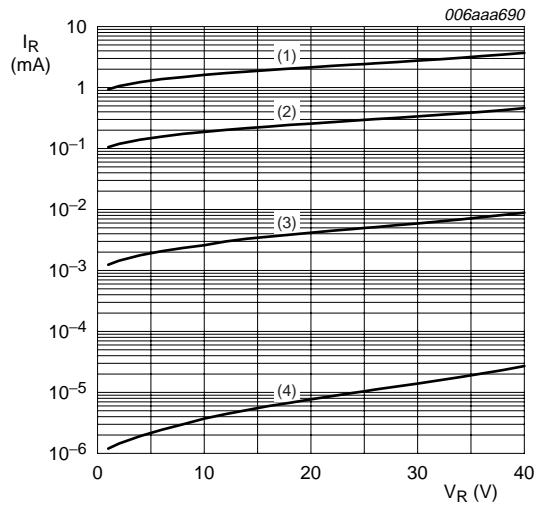

- (1) $T_{\text{amb}} = 125^\circ\text{C}$
- (2) $T_{\text{amb}} = 85^\circ\text{C}$
- (3) $T_{\text{amb}} = 25^\circ\text{C}$
- (4) $T_{\text{amb}} = -40^\circ\text{C}$

Fig 2. Reverse current as a function of reverse voltage; typical values

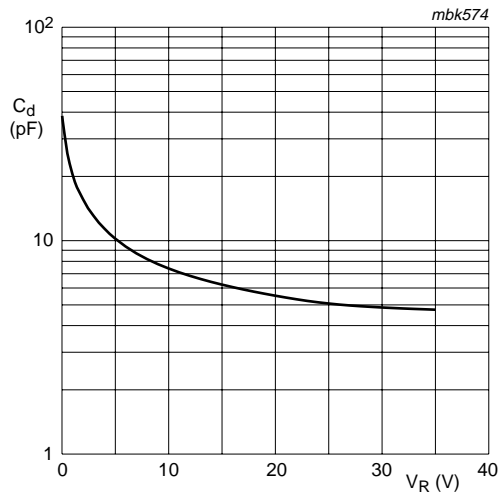

$T_{\text{amb}} = 25^\circ\text{C}; f = 1\text{ MHz}$

Fig 3. Diode capacitance as a function of reverse voltage; typical values

8. Package outline

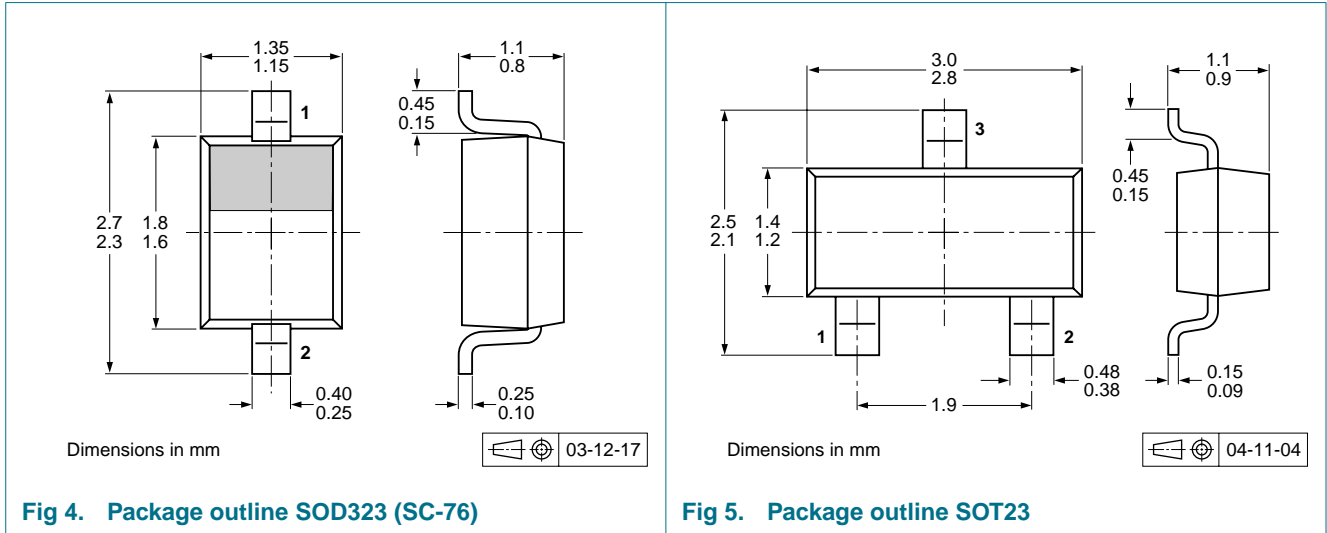

9. Packing information

Table 9. Packing methods

The indicated -xxx are the last three digits of the 12NC ordering code.^[1]

Type number	Package	Description	Packing quantity	
			3000	10000
1PS76SB21	SOD323	4 mm pitch, 8 mm tape and reel	-115	-135
BAT721	SOT23	4 mm pitch, 8 mm tape and reel	-215	-235
BAT721A				
BAT721C				
BAT721S				

[1] For further information and the availability of packing methods, see [Section 13](#).

10. Soldering

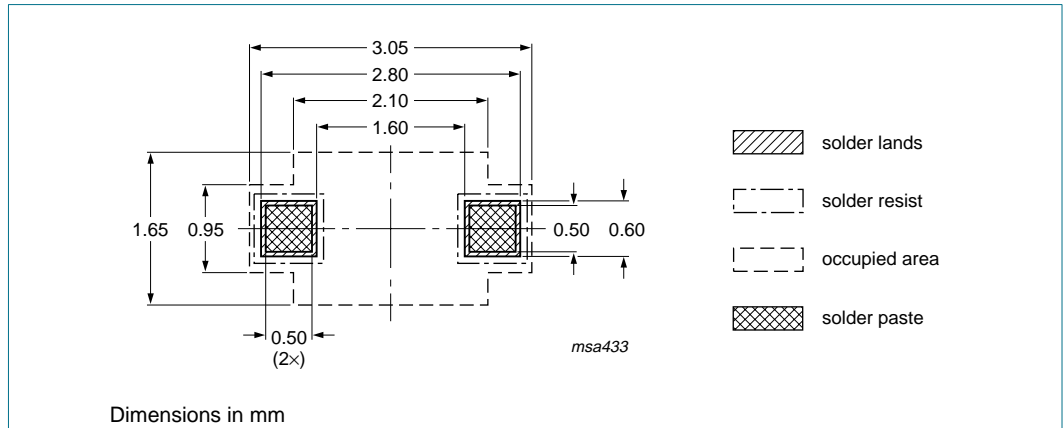

Fig 6. Reflow soldering footprint SOD323 (SC-76)

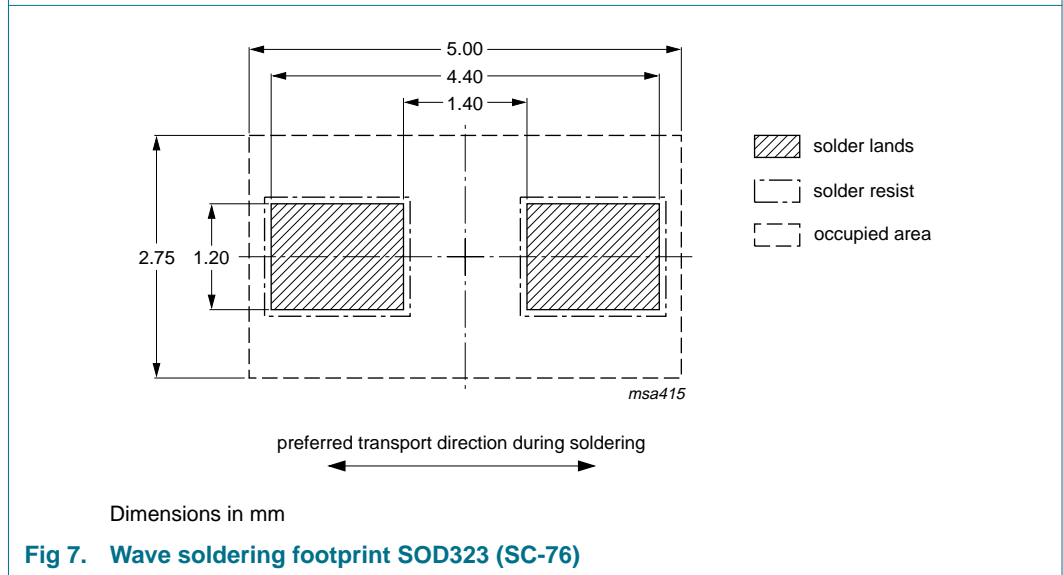

Fig 7. Wave soldering footprint SOD323 (SC-76)

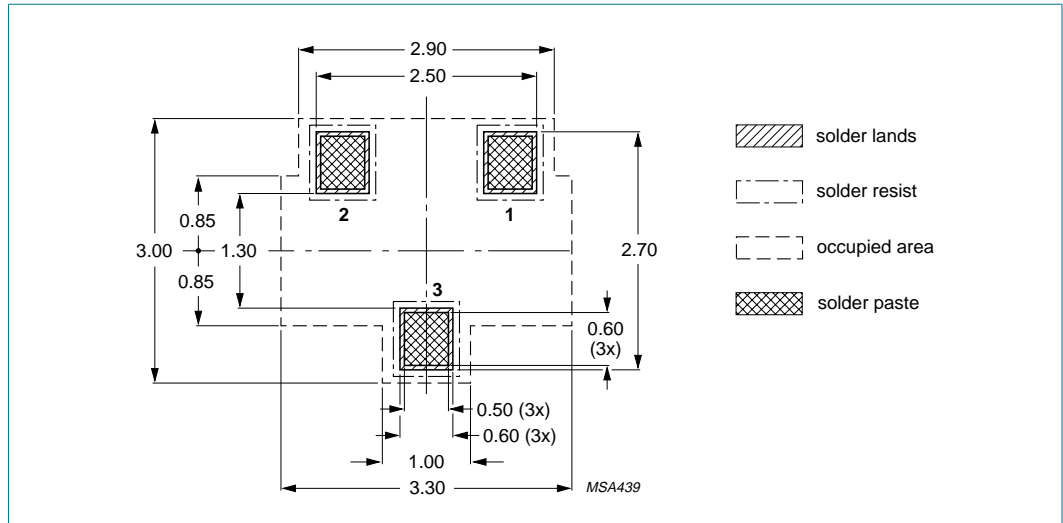

Fig 8. Reflow soldering footprint SOT23

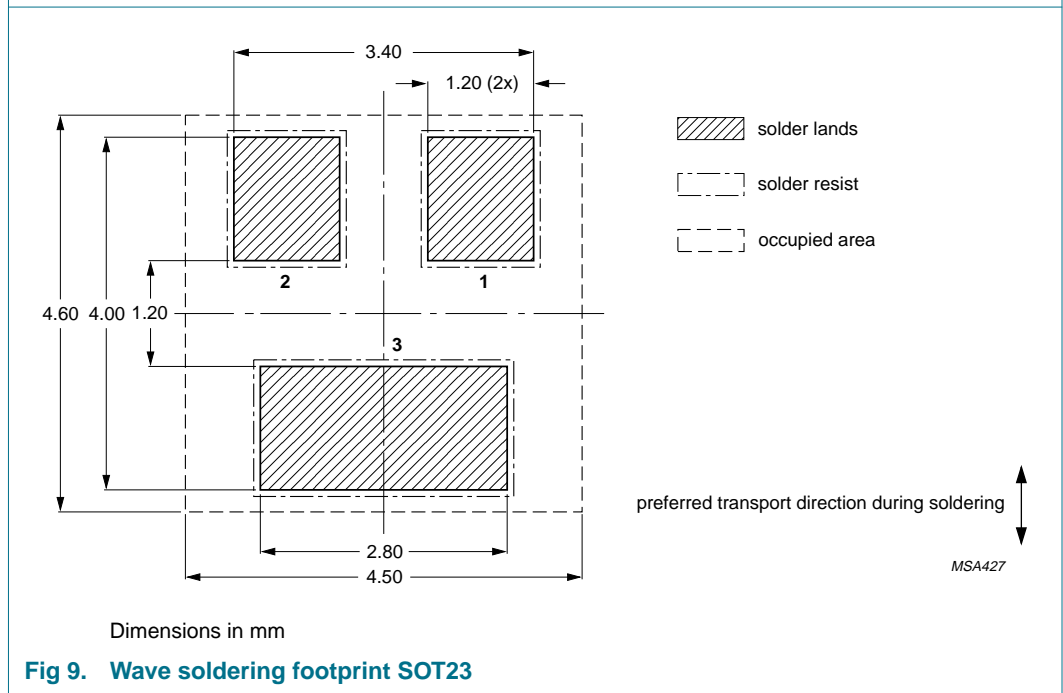

Fig 9. Wave soldering footprint SOT23

11. Revision history

Table 10. Revision history

Document ID	Release date	Data sheet status	Change notice	Supersedes
1PS76SB21_BAT721_SER_6	20061221	Product data sheet	-	1PS76SB21_BAT721_SER_5
Modifications:	<ul style="list-style-type: none"> Amended Table 10 "Revision history" 			
1PS76SB21_BAT721_SER_5	20061205	Product data sheet	-	BAT721_SERIES_4 1PS76SB21_3
Modifications:	<ul style="list-style-type: none"> The format of this data sheet has been redesigned to comply with the new identity guidelines of NXP Semiconductors. Legal texts have been adapted to the new company name where appropriate. This data sheet is a combination of data sheets BAT721_SERIES_4 and 1PS76SB21_3. Table 1 "Product overview": added Section 1.2 "Features": amended Section 1.3 "Applications": amended Table 2 "Quick reference data": added Table 5 "Marking codes": for 1PS76SB21 amended Table 5 "Marking codes": enhanced table note section Table 6 "Limiting values": indication per diode added Table 6 "Limiting values": for 1PS76SB21 I_{FSM} condition amended Table 6 "Limiting values": T_{amb} ambient temperature added Table 7 "Thermal characteristics": indication per diode added Table 7: R_{th(j-a)} thermal resistance from junction to ambient condition amended Table 8 "Characteristics": indication per diode added Table 8 "Characteristics": reference to Table note 1 amended Table 8: for 1PS76SB21 C_d minimum value changed to typical value Figure 1 and 2: amended Figure 4 and 5: superseded by minimized package outlines Section 9 "Packing information": added Section 10 "Soldering": added Section 12 "Legal information": updated 			
BAT721_SERIES_4	20040315	Product specification	-	BAT721_SERIES_3
1PS76SB21_3	20040126	Product specification	-	1PS76SB21_2

12. Legal information

12.1 Data sheet status

Document status ^{[1][2]}	Product status ^[3]	Definition
Objective [short] data sheet	Development	This document contains data from the objective specification for product development.
Preliminary [short] data sheet	Qualification	This document contains data from the preliminary specification.
Product [short] data sheet	Production	This document contains the product specification.

[1] Please consult the most recently issued document before initiating or completing a design.

[2] The term 'short data sheet' is explained in section "Definitions".

[3] The product status of device(s) described in this document may have changed since this document was published and may differ in case of multiple devices. The latest product status information is available on the Internet at URL <http://www.nxp.com>.

12.2 Definitions

Draft — The document is a draft version only. The content is still under internal review and subject to formal approval, which may result in modifications or additions. NXP Semiconductors does not give any representations or warranties as to the accuracy or completeness of information included herein and shall have no liability for the consequences of use of such information.

Short data sheet — A short data sheet is an extract from a full data sheet with the same product type number(s) and title. A short data sheet is intended for quick reference only and should not be relied upon to contain detailed and full information. For detailed and full information see the relevant full data sheet, which is available on request via the local NXP Semiconductors sales office. In case of any inconsistency or conflict with the short data sheet, the full data sheet shall prevail.

12.3 Disclaimers

General — Information in this document is believed to be accurate and reliable. However, NXP Semiconductors does not give any representations or warranties, expressed or implied, as to the accuracy or completeness of such information and shall have no liability for the consequences of use of such information.

Right to make changes — NXP Semiconductors reserves the right to make changes to information published in this document, including without limitation specifications and product descriptions, at any time and without notice. This document supersedes and replaces all information supplied prior to the publication hereof.

Suitability for use — NXP Semiconductors products are not designed, authorized or warranted to be suitable for use in medical, military, aircraft, space or life support equipment, nor in applications where failure or

malfunction of a NXP Semiconductors product can reasonably be expected to result in personal injury, death or severe property or environmental damage. NXP Semiconductors accepts no liability for inclusion and/or use of NXP Semiconductors products in such equipment or applications and therefore such inclusion and/or use is at the customer's own risk.

Applications — Applications that are described herein for any of these products are for illustrative purposes only. NXP Semiconductors makes no representation or warranty that such applications will be suitable for the specified use without further testing or modification.

Limiting values — Stress above one or more limiting values (as defined in the Absolute Maximum Ratings System of IEC 60134) may cause permanent damage to the device. Limiting values are stress ratings only and operation of the device at these or any other conditions above those given in the Characteristics sections of this document is not implied. Exposure to limiting values for extended periods may affect device reliability.

Terms and conditions of sale — NXP Semiconductors products are sold subject to the general terms and conditions of commercial sale, as published at <http://www.nxp.com/profile/terms>, including those pertaining to warranty, intellectual property rights infringement and limitation of liability, unless explicitly otherwise agreed to in writing by NXP Semiconductors. In case of any inconsistency or conflict between information in this document and such terms and conditions, the latter will prevail.

No offer to sell or license — Nothing in this document may be interpreted or construed as an offer to sell products that is open for acceptance or the grant, conveyance or implication of any license under any copyrights, patents or other industrial or intellectual property rights.

12.4 Trademarks

Notice: All referenced brands, product names, service names and trademarks are the property of their respective owners.

13. Contact information

For additional information, please visit: <http://www.nxp.com>

For sales office addresses, send an email to: salesaddresses@nxp.com

14. Contents

1	Product profile	1
1.1	General description	1
1.2	Features	1
1.3	Applications	1
1.4	Quick reference data	1
2	Pinning information	2
3	Ordering information	3
4	Marking	3
5	Limiting values	3
6	Thermal characteristics	4
7	Characteristics	4
8	Package outline	6
9	Packing information	6
10	Soldering	7
11	Revision history	9
12	Legal information	10
12.1	Data sheet status	10
12.2	Definitions	10
12.3	Disclaimers	10
12.4	Trademarks	10
13	Contact information	10
14	Contents	11

Please be aware that important notices concerning this document and the product(s) described herein, have been included in section 'Legal information'.



© NXP B.V. 2006.

All rights reserved.

For more information, please visit: <http://www.nxp.com>

For sales office addresses, please send an email to: salesaddresses@nxp.com

Date of release: 21 December 2006

Document identifier: 1PS76SB21_BAT721_SER_6