

# BYV32E-200

Dual rugged ultrafast rectifier diode, 20 A, 200 V

Rev. 04 — 27 February 2009

Product data sheet

## 1. Product profile

### 1.1 General description

Ultrafast dual epitaxial rectifier diode in a SOT78 (TO-220AB) plastic package.

### 1.2 Features and benefits

- High reverse voltage surge capability
- High thermal cycling performance
- Low thermal resistance
- Soft recovery characteristic minimizes power consuming oscillations
- Very low on-state loss

### 1.3 Applications

- Output rectifiers in high-frequency switched-mode power supplies

### 1.4 Quick reference data

Table 1. Quick reference

Symbol	Parameter	Conditions	Min	Typ	Max	Unit
$V_{RRM}$	repetitive peak reverse voltage		-	-	200	V
$I_{O(AV)}$	average output current	square-wave pulse; $\delta = 0.5$ ; $T_{mb} \leq 115\text{ °C}$ ; both diodes conducting; see <a href="#">Figure 1</a> ; see <a href="#">Figure 2</a>	-	-	20	A
$I_{RRM}$	repetitive peak reverse current	$t_p = 2\ \mu\text{s}$ ; $\delta = 0.001$	-	-	0.2	A
$V_{ESD}$	electrostatic discharge voltage	HBM; $C = 250\ \text{pF}$ ; $R = 1.5\ \text{k}\Omega$ ; all pins	-	-	8	kV
<b>Dynamic characteristics</b>						
$t_{rr}$	reverse recovery time	$I_F = 1\ \text{A}$ ; $V_R = 30\ \text{V}$ ; $dI_F/dt = 100\ \text{A}/\mu\text{s}$ ; $T_j = 25\text{ °C}$ ; ramp recovery; see <a href="#">Figure 5</a>	-	20	25	ns
		$I_R = 1\ \text{A}$ ; $I_F = 0.5\ \text{A}$ ; $T_j = 25\text{ °C}$ ; step recovery; measured at reverse current = 0.25 A; see <a href="#">Figure 6</a>	-	10	20	ns
<b>Static characteristics</b>						
$V_F$	forward voltage	$I_F = 8\ \text{A}$ ; $T_j = 150\text{ °C}$ ; see <a href="#">Figure 4</a>	-	0.72	0.85	V

## 2. Pinning information

**Table 2. Pinning information**

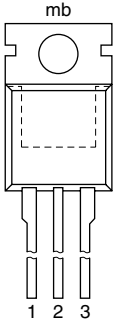
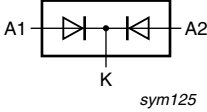
Pin	Symbol	Description	Simplified outline	Graphic symbol
1	A1	anode 1		
2	K	cathode		
3	A2	anode 2		
mb	K	mounting base; cathode		

**SOT78**  
(TO-220AB; SC-46)

## 3. Ordering information

**Table 3. Ordering information**

Type number	Package	Description	Version
	Name		
BYV32E-200	TO-220AB;	plastic single-ended package; heatsink mounted; 1 mounting hole; 3-lead	SOT78
	SC-46		

### 4. Limiting values

**Table 4. Limiting values**

In accordance with the Absolute Maximum Rating System (IEC 60134).

Symbol	Parameter	Conditions	Min	Max	Unit
$V_{RRM}$	repetitive peak reverse voltage		-	200	V
$V_{RWM}$	crest working reverse voltage		-	200	V
$V_R$	reverse voltage	DC	-	200	V
$I_{O(AV)}$	average output current	square-wave pulse; $\delta = 0.5$ ; $T_{mb} \leq 115\text{ }^\circ\text{C}$ ; both diodes conducting; see <a href="#">Figure 1</a> ; see <a href="#">Figure 2</a>	-	20	A
$I_{FRM}$	repetitive peak forward current	$\delta = 0.5$ ; $t_p = 25\text{ }\mu\text{s}$ ; $T_{mb} \leq 115\text{ }^\circ\text{C}$ ; per diode	-	20	A
$I_{FSM}$	non-repetitive peak forward current	$t_p = 8.3\text{ ms}$ ; sine-wave pulse; $T_{j(\text{init})} = 25\text{ }^\circ\text{C}$ ; per diode	-	137	A
		$t_p = 10\text{ ms}$ ; sine-wave pulse; $T_{j(\text{init})} = 25\text{ }^\circ\text{C}$ ; per diode	-	125	A
$I_{RRM}$	repetitive peak reverse current	$\delta = 0.001$ ; $t_p = 2\text{ }\mu\text{s}$	-	0.2	A
$I_{RSM}$	non-repetitive peak reverse current	$t_p = 100\text{ }\mu\text{s}$	-	0.2	A
$T_{stg}$	storage temperature		-40	150	$^\circ\text{C}$
$T_j$	junction temperature		-	150	$^\circ\text{C}$
$V_{ESD}$	electrostatic discharge voltage	HBM; C = 250 pF; R = 1.5 k $\Omega$ ; all pins	-	8	kV

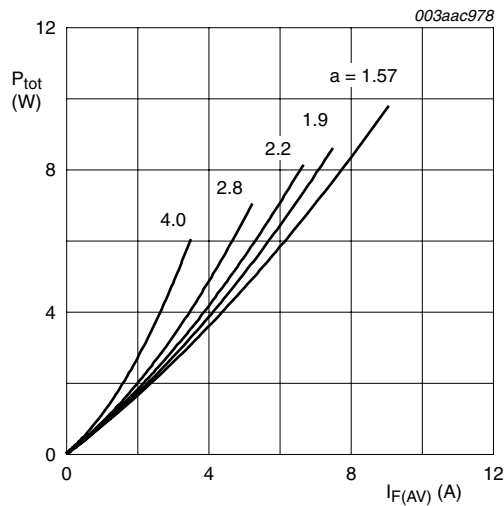

$$a = \text{form factor} = I_{F(RMS)} / I_{F(AV)}$$

**Fig 1. Forward power dissipation as a function of average forward current; sinusoidal waveform; maximum values**

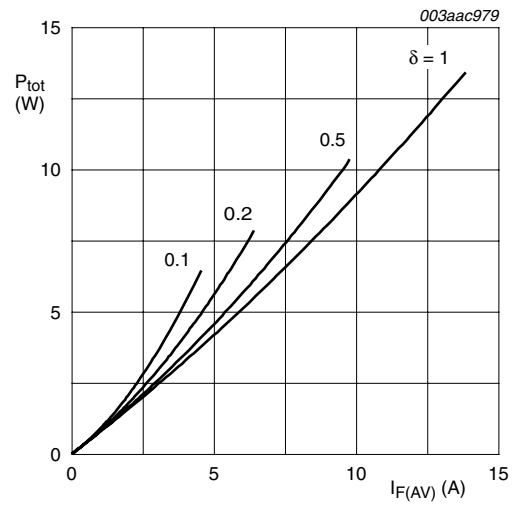

$$I_{F(AV)} = I_{F(RMS)} \times \sqrt{\delta}$$

**Fig 2. Forward power dissipation as a function of average forward current; square waveform; maximum values**

## 5. Thermal characteristics

Table 5. Thermal characteristics

Symbol	Parameter	Conditions	Min	Typ	Max	Unit
$R_{th(j-mb)}$	thermal resistance from junction to mounting base	with heatsink compound; both diodes conducting	-	-	1.6	K/W
		with heatsink compound; per diode; see <a href="#">Figure 3</a>	-	-	2.4	K/W
$R_{th(j-a)}$	thermal resistance from junction to ambient		-	60	-	K/W

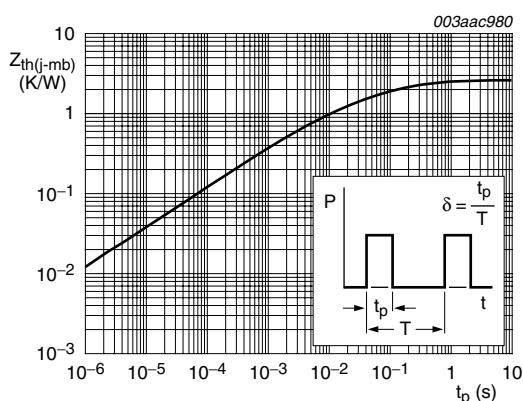
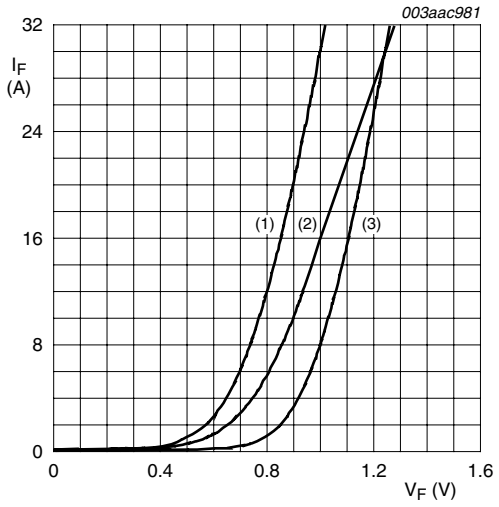

Fig 3. Transient thermal impedance from junction to mounting base as a function of pulse width

## 6. Characteristics

Table 6. Characteristics

Symbol	Parameter	Conditions	Min	Typ	Max	Unit
<b>Static characteristics</b>						
$V_F$	forward voltage	$I_F = 20\text{ A}; T_j = 25\text{ °C}$	-	1	1.15	V
		$I_F = 8\text{ A}; T_j = 150\text{ °C}$ ; see <a href="#">Figure 4</a>	-	0.72	0.85	V
$I_R$	reverse current	$V_R = 200\text{ V}; T_j = 100\text{ °C}$	-	0.2	0.6	mA
		$V_R = 200\text{ V}; T_j = 25\text{ °C}$	-	6	30	$\mu\text{A}$
<b>Dynamic characteristics</b>						
$Q_r$	recovered charge	$I_F = 2\text{ A}; V_R = 30\text{ V}; di_F/dt = 20\text{ A}/\mu\text{s}; T_j = 25\text{ °C}$	-	8	12.5	nC
$t_{rr}$	reverse recovery time	$I_F = 1\text{ A}; V_R = 30\text{ V}; di_F/dt = 100\text{ A}/\mu\text{s};$ ramp recovery; $T_j = 25\text{ °C}$ ; see <a href="#">Figure 5</a>	-	20	25	ns
		$I_F = 0.5\text{ A}; I_R = 1\text{ A};$ step recovery; measured at reverse current = 0.25 A; $T_j = 25\text{ °C}$ ; see <a href="#">Figure 6</a>	-	10	20	ns
$V_{FR}$	forward recovery voltage	$I_F = 1\text{ A}; di_F/dt = 10\text{ A}/\mu\text{s}; T_j = 25\text{ °C}$ ; see <a href="#">Figure 7</a>	-	-	1	V



- (1)  $T_j = 150\text{ }^\circ\text{C}$ ; typical values
- (2)  $T_j = 150\text{ }^\circ\text{C}$ ; maximum values
- (3)  $T_j = 25\text{ }^\circ\text{C}$ ; maximum values

Fig 4. Forward current as a function of forward voltage

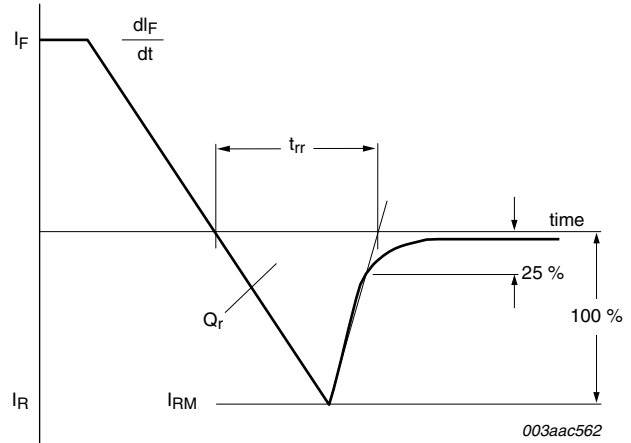

Fig 5. Reverse recovery definitions; ramp recovery

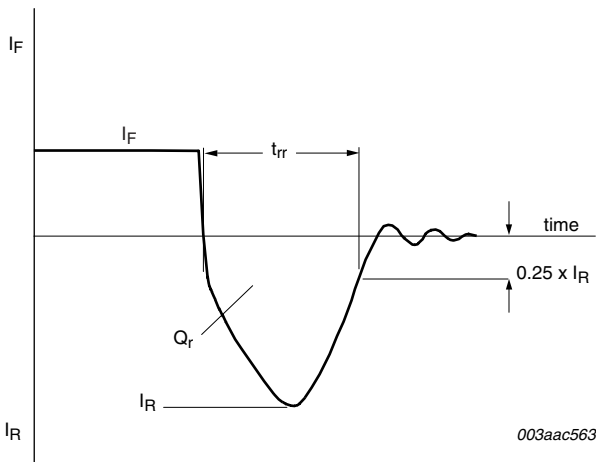

Fig 6. Reverse recovery definitions; step recovery

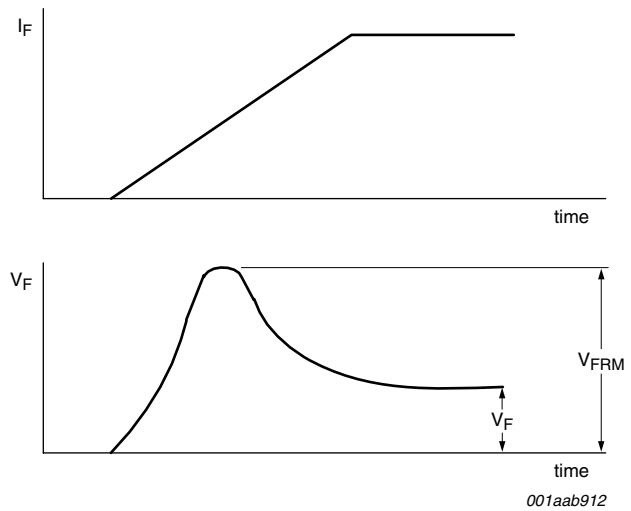

Fig 7. Forward recovery definitions

7. Package outline

Plastic single-ended package; heatsink mounted; 1 mounting hole; 3-lead TO-220AB

SOT78

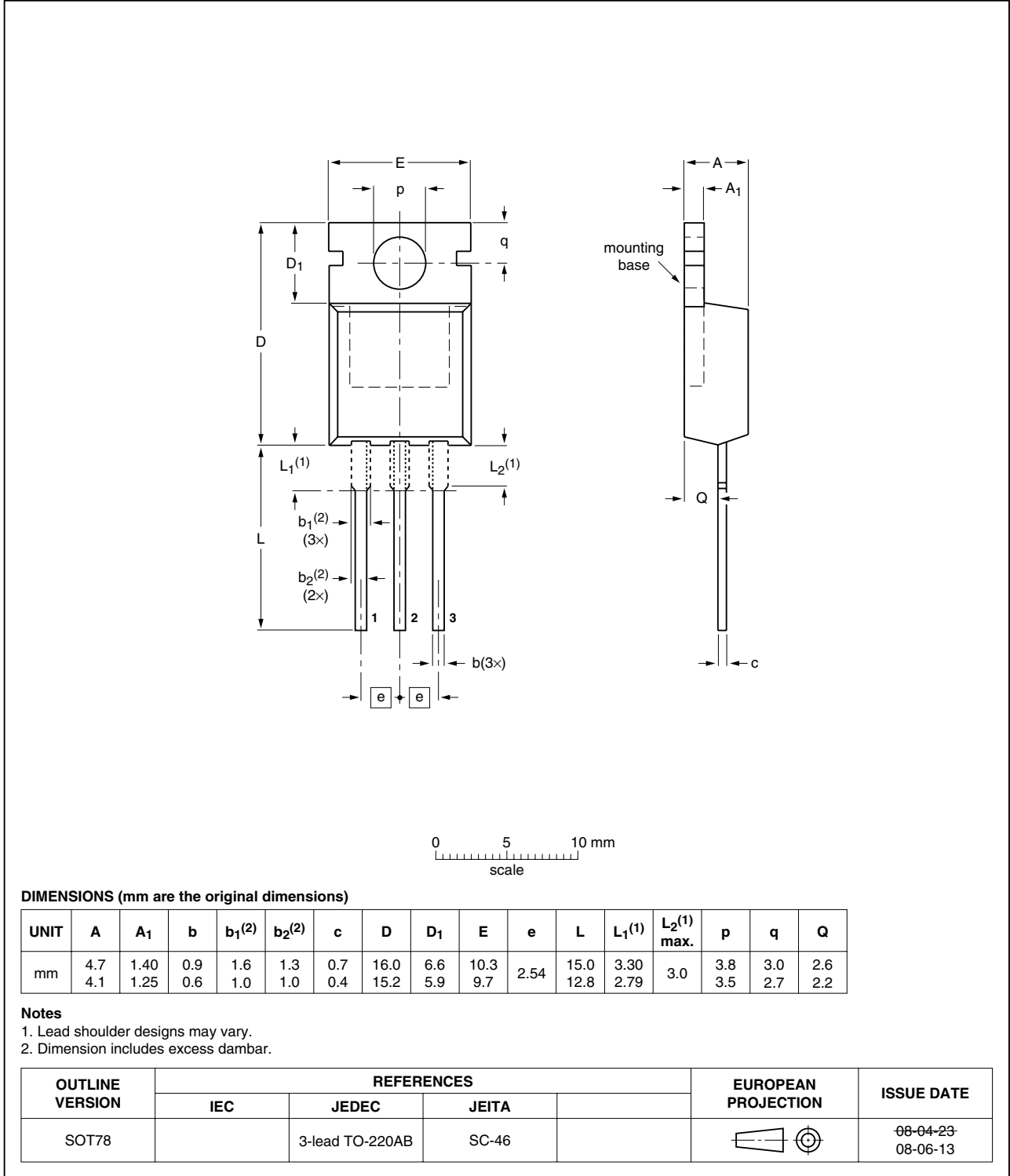

Fig 8. Package outline SOT78 (TO-220AB)

## 8. Revision history

**Table 7.** Revision history

Document ID	Release date	Data sheet status	Change notice	Supersedes
BYV32E-200_4	20090227	Product data sheet	-	BYV32E_SERIES_3
Modifications:		<ul style="list-style-type: none"> <li>The format of this data sheet has been redesigned to comply with the new identity guidelines of NXP Semiconductors.</li> <li>Legal texts have been adapted to the new company name where appropriate.</li> <li>Package outline updated.</li> <li>Type number BYV32E-200 separated from data sheet BYV32E_SERIES_3</li> </ul>		
BYV32E_SERIES_3	20010301	Product specification	-	BYV32E_SERIES_2
BYV32E_SERIES_2	19980701	Product specification	-	BYV32EB_SERIES_1
BYV32EB_SERIES_1	19960801	Product specification	-	-

## 9. Legal information

### 9.1 Data sheet status

Document status <sup>[1][2]</sup>	Product status <sup>[3]</sup>	Definition
Objective [short] data sheet	Development	This document contains data from the objective specification for product development.
Preliminary [short] data sheet	Qualification	This document contains data from the preliminary specification.
Product [short] data sheet	Production	This document contains the product specification.

[1] Please consult the most recently issued document before initiating or completing a design.

[2] The term 'short data sheet' is explained in section "Definitions".

[3] The product status of device(s) described in this document may have changed since this document was published and may differ in case of multiple devices. The latest product status information is available on the Internet at URL <http://www.nxp.com>.

### 9.2 Definitions

**Draft** — The document is a draft version only. The content is still under internal review and subject to formal approval, which may result in modifications or additions. NXP Semiconductors does not give any representations or warranties as to the accuracy or completeness of information included herein and shall have no liability for the consequences of use of such information.

**Short data sheet** — A short data sheet is an extract from a full data sheet with the same product type number(s) and title. A short data sheet is intended for quick reference only and should not be relied upon to contain detailed and full information. For detailed and full information see the relevant full data sheet, which is available on request via the local NXP Semiconductors sales office. In case of any inconsistency or conflict with the short data sheet, the full data sheet shall prevail.

### 9.3 Disclaimers

**General** — Information in this document is believed to be accurate and reliable. However, NXP Semiconductors does not give any representations or warranties, expressed or implied, as to the accuracy or completeness of such information and shall have no liability for the consequences of use of such information.

**Right to make changes** — NXP Semiconductors reserves the right to make changes to information published in this document, including without limitation specifications and product descriptions, at any time and without notice. This document supersedes and replaces all information supplied prior to the publication hereof.

**Suitability for use** — NXP Semiconductors products are not designed, authorized or warranted to be suitable for use in medical, military, aircraft, space or life support equipment, nor in applications where failure or malfunction of an NXP Semiconductors product can reasonably be expected to result in personal injury, death or severe property or environmental

damage. NXP Semiconductors accepts no liability for inclusion and/or use of NXP Semiconductors products in such equipment or applications and therefore such inclusion and/or use is at the customer's own risk.

**Applications** — Applications that are described herein for any of these products are for illustrative purposes only. NXP Semiconductors makes no representation or warranty that such applications will be suitable for the specified use without further testing or modification.

**Quick reference data** — The Quick reference data is an extract of the product data given in the Limiting values and Characteristics sections of this document, and as such is not complete, exhaustive or legally binding.

**Limiting values** — Stress above one or more limiting values (as defined in the Absolute Maximum Ratings System of IEC 60134) may cause permanent damage to the device. Limiting values are stress ratings only and operation of the device at these or any other conditions above those given in the Characteristics sections of this document is not implied. Exposure to limiting values for extended periods may affect device reliability.

**Terms and conditions of sale** — NXP Semiconductors products are sold subject to the general terms and conditions of commercial sale, as published at <http://www.nxp.com/profile/terms>, including those pertaining to warranty, intellectual property rights infringement and limitation of liability, unless explicitly otherwise agreed to in writing by NXP Semiconductors. In case of any inconsistency or conflict between information in this document and such terms and conditions, the latter will prevail.

**No offer to sell or license** — Nothing in this document may be interpreted or construed as an offer to sell products that is open for acceptance or the grant, conveyance or implication of any license under any copyrights, patents or other industrial or intellectual property rights.

### 9.4 Trademarks

Notice: All referenced brands, product names, service names and trademarks are the property of their respective owners.

## 10. Contact information

For more information, please visit: <http://www.nxp.com>

For sales office addresses, please send an email to: [salesaddresses@nxp.com](mailto:salesaddresses@nxp.com)

## 11. Contents

<b>1</b>	<b>Product profile</b> . . . . .	<b>1</b>
1.1	General description . . . . .	1
1.2	Features and benefits . . . . .	1
1.3	Applications . . . . .	1
1.4	Quick reference data . . . . .	1
<b>2</b>	<b>Pinning information</b> . . . . .	<b>2</b>
<b>3</b>	<b>Ordering information</b> . . . . .	<b>2</b>
<b>4</b>	<b>Limiting values</b> . . . . .	<b>3</b>
<b>5</b>	<b>Thermal characteristics</b> . . . . .	<b>4</b>
<b>6</b>	<b>Characteristics</b> . . . . .	<b>4</b>
<b>7</b>	<b>Package outline</b> . . . . .	<b>6</b>
<b>8</b>	<b>Revision history</b> . . . . .	<b>7</b>
<b>9</b>	<b>Legal information</b> . . . . .	<b>8</b>
9.1	Data sheet status . . . . .	8
9.2	Definitions . . . . .	8
9.3	Disclaimers . . . . .	8
9.4	Trademarks . . . . .	8
<b>10</b>	<b>Contact information</b> . . . . .	<b>8</b>



Please be aware that important notices concerning this document and the product(s) described herein, have been included in section 'Legal information'.

© NXP B.V. 2009.

All rights reserved.

For more information, please visit: <http://www.nxp.com>

For sales office addresses, please send an email to: [salesaddresses@nxp.com](mailto:salesaddresses@nxp.com)

Date of release: 27 February 2009

Document identifier: BYV32E-200\_4