

DATA SHEET

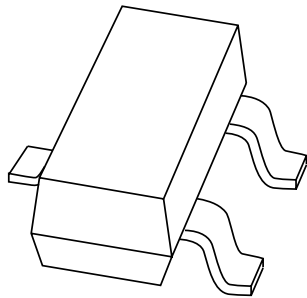

PMBD6100 High-speed double diode

Product data sheet
Supersedes data of 1999 May 11

2003 Mar 25

High-speed double diode

PMBD6100

FEATURES

- Small plastic SMD package
- High switching speed: max. 4 ns
- General application
- Continuous reverse voltage: max. 70 V
- Repetitive peak reverse voltage: max. 85 V
- Repetitive peak forward current: max. 450 mA.

APPLICATIONS

- High-speed switching in surface mounted circuits.

MARKING

TYPE NUMBER	MARKING CODE ⁽¹⁾
PMBD6100	*5B

Note

- * = p : Made in Hong Kong.
 * = t : Made in Malaysia.
 * = W : Made in China.

DESCRIPTION

The PMBD6100 consists of two high-speed switching diodes with common cathodes, fabricated in planar technology, and encapsulated in the small SOT23 plastic SMD package.

PINNING

PIN	DESCRIPTION
1	anode (a1)
2	anode (a2)
3	common cathode

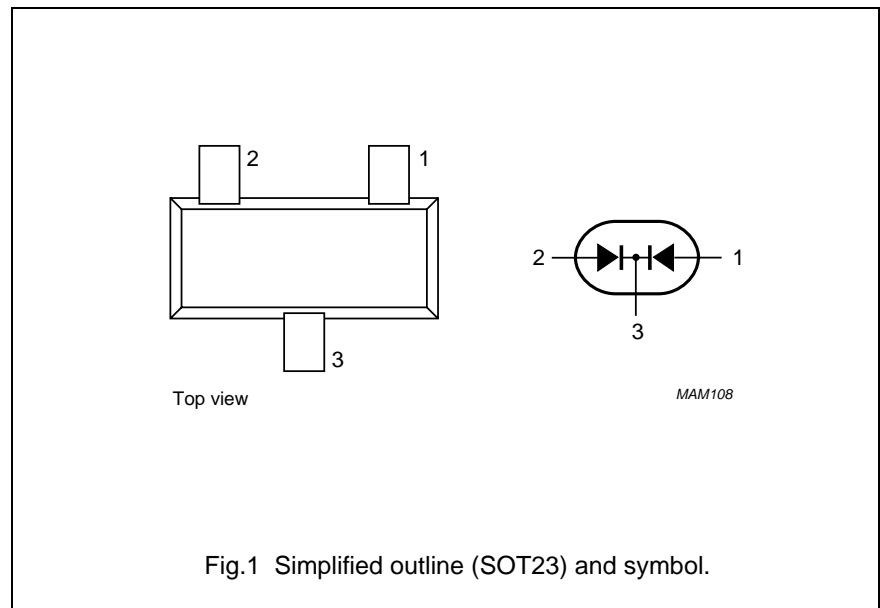

LIMITING VALUES

In accordance with the Absolute Maximum Rating System (IEC 60134).

SYMBOL	PARAMETER	CONDITIONS	MIN.	MAX.	UNIT
Per diode					
V_{RRM}	repetitive peak reverse voltage		–	85	V
V_R	continuous reverse voltage		–	70	V
I_F	continuous forward current	single diode loaded; note 1; see Fig.2	–	215	mA
		double diode loaded; note 1; see Fig.2	–	125	mA

High-speed double diode

PMBD6100

SYMBOL	PARAMETER	CONDITIONS	MIN.	MAX.	UNIT
I_{FRM}	repetitive peak forward current		–	450	mA
I_{FSM}	non-repetitive peak forward current	square wave; $T_j = 25\text{ °C}$ prior to surge; see Fig.4 $t = 1\ \mu\text{s}$ $t = 1\ \text{ms}$ $t = 1\ \text{s}$	– – –	4 1 0.5	A A A
P_{tot}	total power dissipation	$T_{amb} = 25\text{ °C}$; note 1	–	250	mW
T_{stg}	storage temperature		–65	+150	°C
T_j	junction temperature		–	150	°C

Note

1. Device mounted on an FR4 printed-circuit board.

ELECTRICAL CHARACTERISTICS

$T_j = 25\text{ °C}$ unless otherwise specified.

SYMBOL	PARAMETER	CONDITIONS	MIN.	MAX.	UNIT
Per diode					
V_F	forward voltage	see Fig.3 $I_F = 1\ \text{mA}$ $I_F = 10\ \text{mA}$ $I_F = 50\ \text{mA}$ $I_F = 100\ \text{mA}$	550 – – 0.85	700 855 1 1.1	mV mV V V
I_R	reverse current	see Fig.5 $V_R = 50\ \text{V}$ $V_R = 50\ \text{V}; T_j = 150\text{ °C}$	– –	100 50	nA μA
C_d	diode capacitance	$f = 1\ \text{MHz}; V_R = 0$; see Fig.6	–	1.5	pF
t_{rr}	reverse recovery time	when switched from $I_F = 10\ \text{mA}$ to $I_R = 10\ \text{mA}$; $R_L = 100\ \Omega$; measured at $I_R = 1\ \text{mA}$; see Fig.7	–	4	ns
V_{fr}	forward recovery voltage	when switched from $I_F = 10\ \text{mA}$; $t_r = 20\ \text{ns}$; see Fig.8	–	1.75	V

THERMAL CHARACTERISTICS

SYMBOL	PARAMETER	CONDITIONS	VALUE	UNIT
$R_{th\ j-tp}$	thermal resistance from junction to tie-point		360	K/W
$R_{th\ j-a}$	thermal resistance from junction to ambient	note 1	500	K/W

Note

1. Device mounted on an FR4 printed-circuit board.

High-speed double diode

PMBD6100

GRAPHICAL DATA

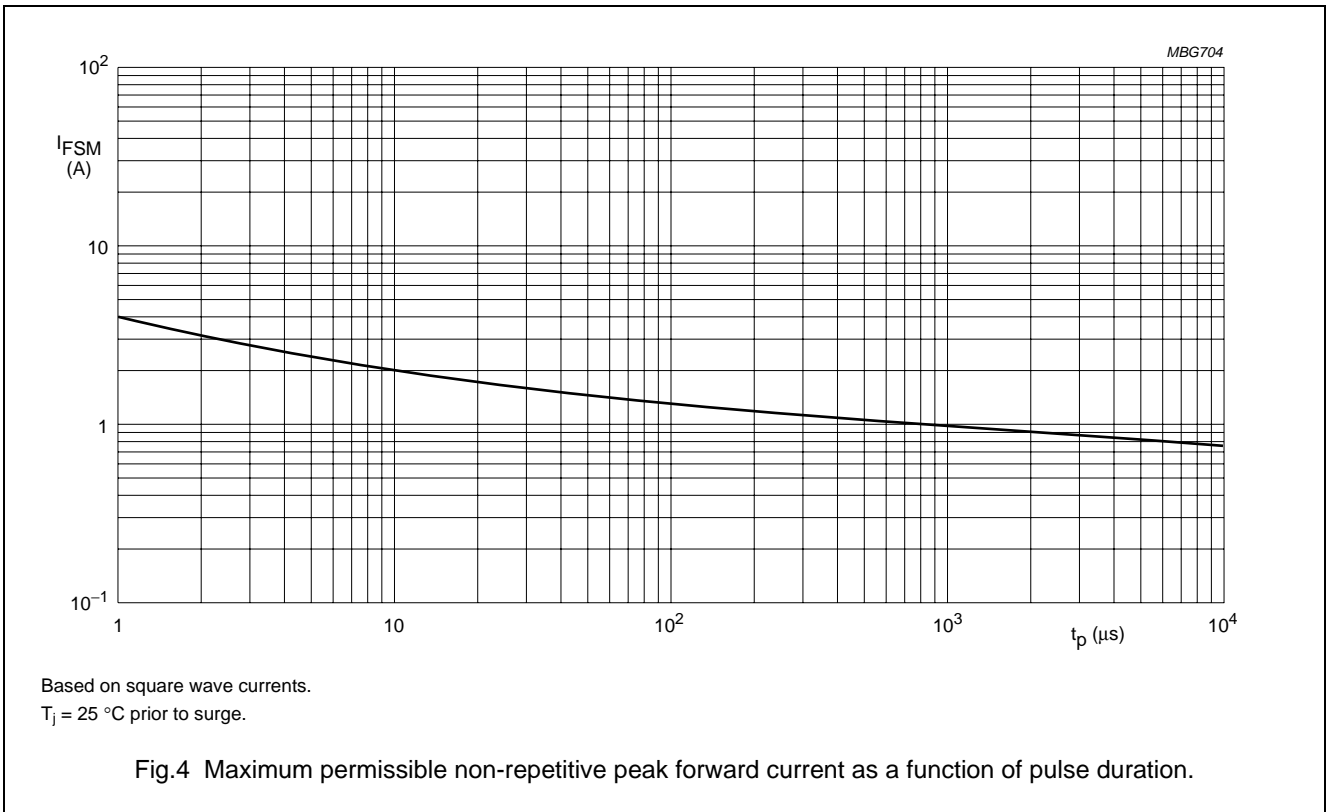
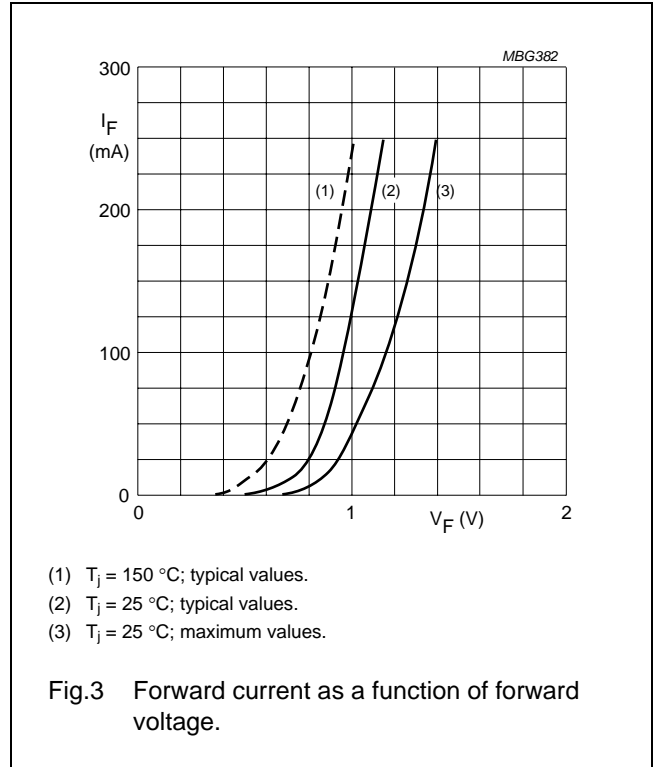
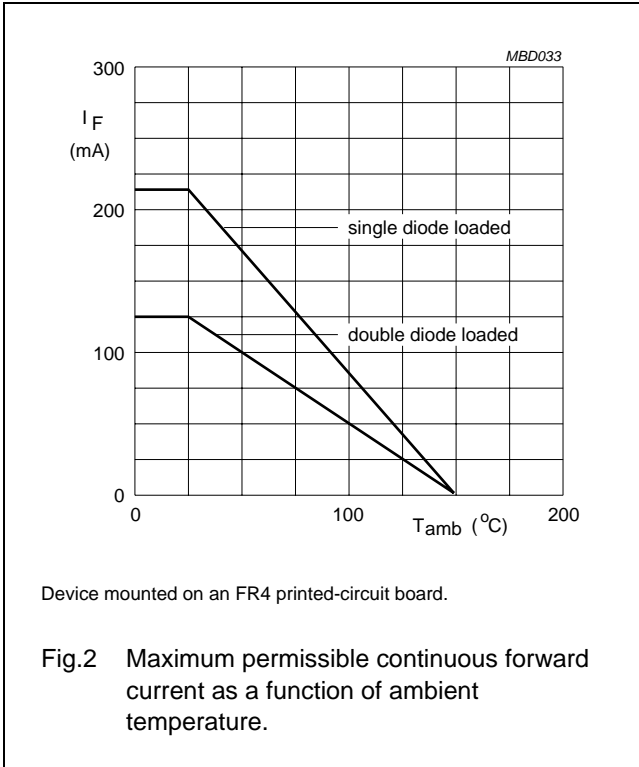

High-speed double diode

PMBD6100

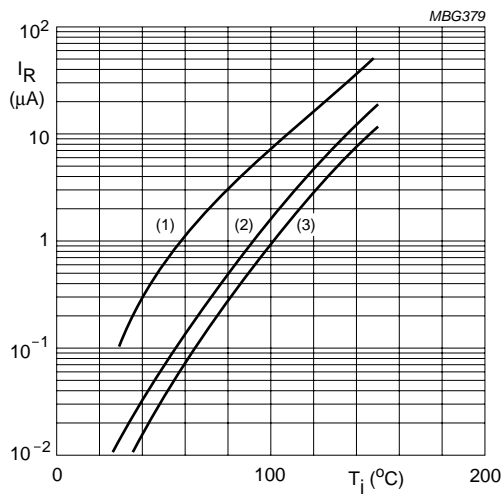

- (1) $V_R = 50\text{ V}$; maximum values.
- (2) $V_R = 50\text{ V}$; typical values.
- (3) $V_R = 30\text{ V}$; typical values.

Fig.5 Reverse current as a function of junction temperature.

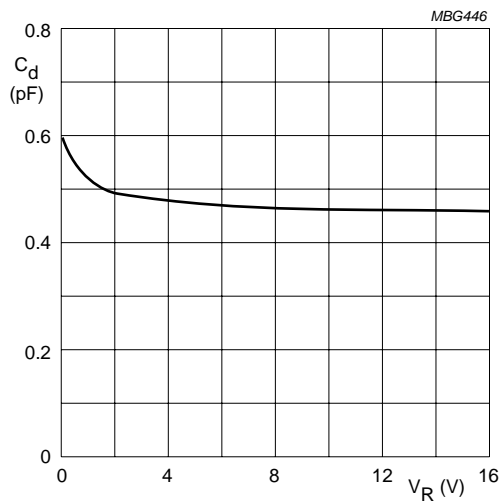

$f = 1\text{ MHz}$; $T_j = 25\text{ }^\circ\text{C}$.

Fig.6 Diode capacitance as a function of reverse voltage; typical values.

High-speed double diode

PMBD6100

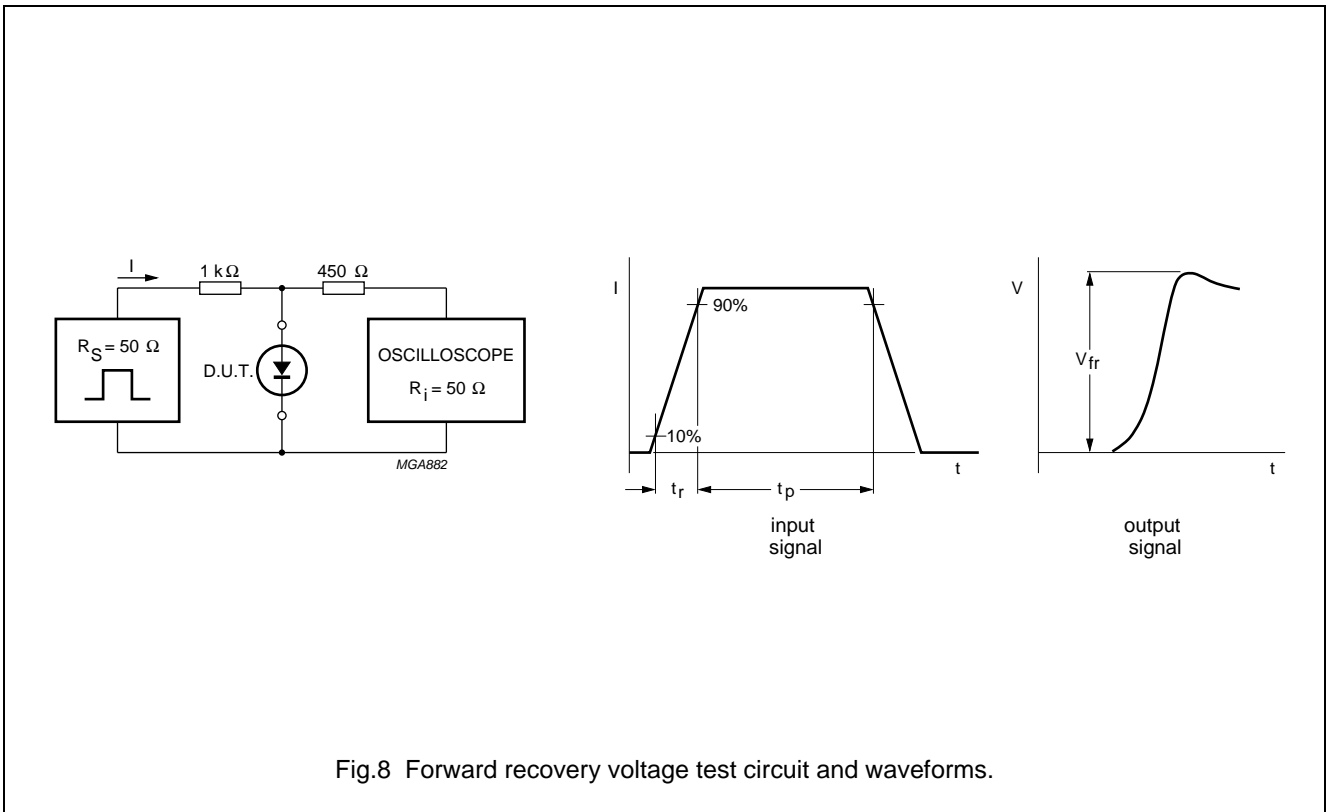
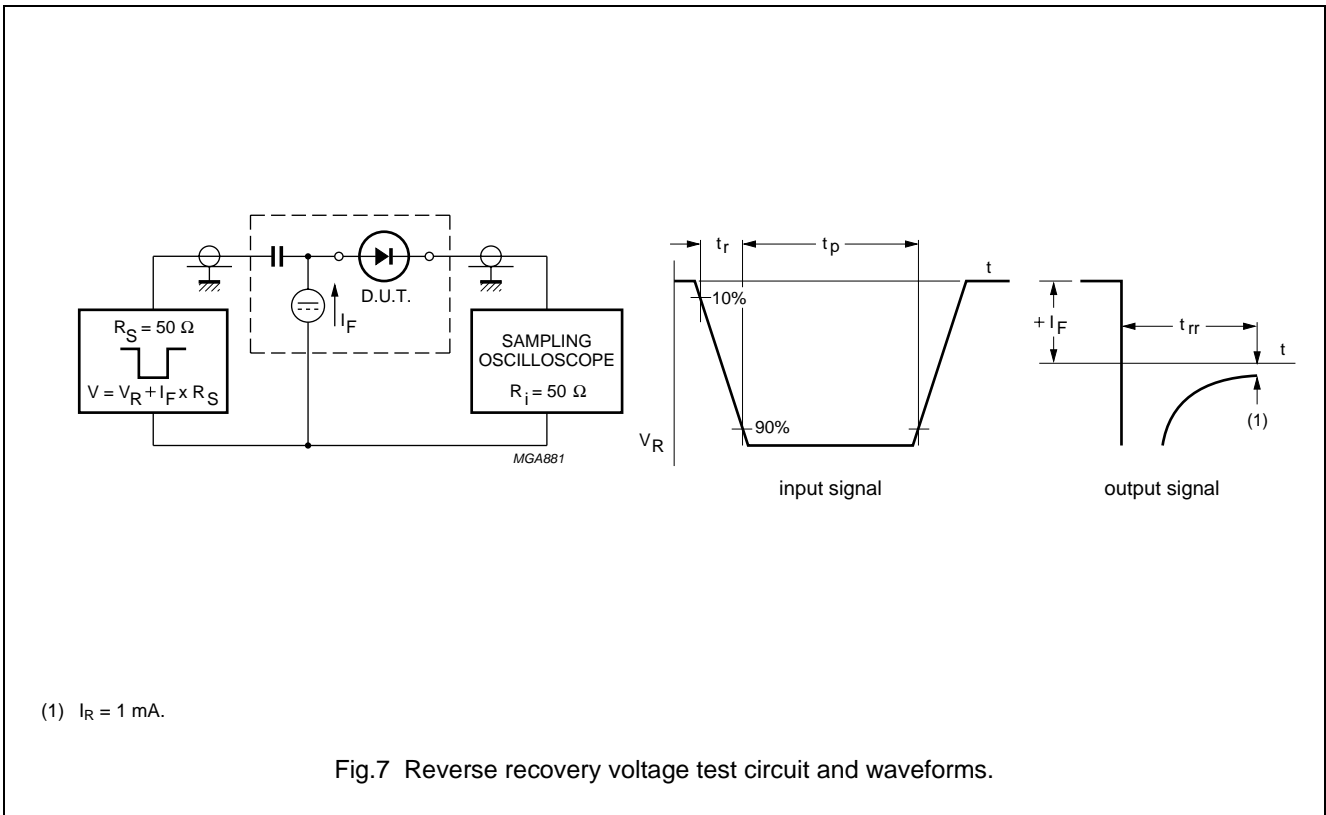

High-speed double diode

PMBD6100

PACKAGE OUTLINE

Plastic surface mounted package; 3 leads

SOT23

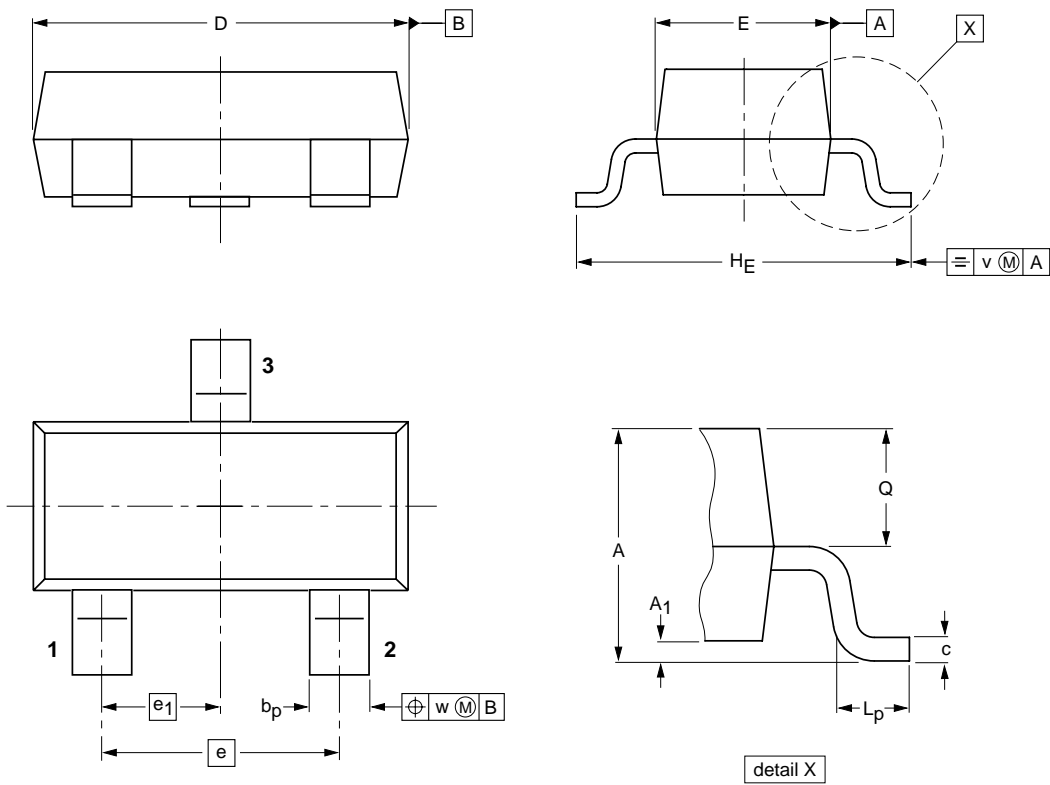

DIMENSIONS (mm are the original dimensions)

UNIT	A	A ₁ max.	b _p	c	D	E	e	e ₁	H _E	L _p	Q	v	w
mm	1.1 0.9	0.1	0.48 0.38	0.15 0.09	3.0 2.8	1.4 1.2	1.9	0.95	2.5 2.1	0.45 0.15	0.55 0.45	0.2	0.1

OUTLINE VERSION	REFERENCES			EUROPEAN PROJECTION	ISSUE DATE
	IEC	JEDEC	EIAJ		
SOT23		TO-236AB			97-02-28 99-09-13

High-speed double diode

PMBD6100

DATA SHEET STATUS

DOCUMENT STATUS ⁽¹⁾	PRODUCT STATUS ⁽²⁾	DEFINITION
Objective data sheet	Development	This document contains data from the objective specification for product development.
Preliminary data sheet	Qualification	This document contains data from the preliminary specification.
Product data sheet	Production	This document contains the product specification.

Notes

1. Please consult the most recently issued document before initiating or completing a design.
2. The product status of device(s) described in this document may have changed since this document was published and may differ in case of multiple devices. The latest product status information is available on the Internet at URL <http://www.nxp.com>.

DISCLAIMERS

General — Information in this document is believed to be accurate and reliable. However, NXP Semiconductors does not give any representations or warranties, expressed or implied, as to the accuracy or completeness of such information and shall have no liability for the consequences of use of such information.

Right to make changes — NXP Semiconductors reserves the right to make changes to information published in this document, including without limitation specifications and product descriptions, at any time and without notice. This document supersedes and replaces all information supplied prior to the publication hereof.

Suitability for use — NXP Semiconductors products are not designed, authorized or warranted to be suitable for use in medical, military, aircraft, space or life support equipment, nor in applications where failure or malfunction of an NXP Semiconductors product can reasonably be expected to result in personal injury, death or severe property or environmental damage. NXP Semiconductors accepts no liability for inclusion and/or use of NXP Semiconductors products in such equipment or applications and therefore such inclusion and/or use is at the customer's own risk.

Applications — Applications that are described herein for any of these products are for illustrative purposes only. NXP Semiconductors makes no representation or warranty that such applications will be suitable for the specified use without further testing or modification.

Limiting values — Stress above one or more limiting values (as defined in the Absolute Maximum Ratings System of IEC 60134) may cause permanent damage to the device. Limiting values are stress ratings only and operation of the device at these or any other conditions above those given in the Characteristics sections of this document is not implied. Exposure to limiting values for extended periods may affect device reliability.

Terms and conditions of sale — NXP Semiconductors products are sold subject to the general terms and conditions of commercial sale, as published at <http://www.nxp.com/profile/terms>, including those pertaining to warranty, intellectual property rights infringement and limitation of liability, unless explicitly otherwise agreed to in writing by NXP Semiconductors. In case of any inconsistency or conflict between information in this document and such terms and conditions, the latter will prevail.

No offer to sell or license — Nothing in this document may be interpreted or construed as an offer to sell products that is open for acceptance or the grant, conveyance or implication of any license under any copyrights, patents or other industrial or intellectual property rights.

Export control — This document as well as the item(s) described herein may be subject to export control regulations. Export might require a prior authorization from national authorities.

Quick reference data — The Quick reference data is an extract of the product data given in the Limiting values and Characteristics sections of this document, and as such is not complete, exhaustive or legally binding.

NXP Semiconductors

Customer notification

This data sheet was changed to reflect the new company name NXP Semiconductors. No changes were made to the content, except for the legal definitions and disclaimers.

Contact information

For additional information please visit: **<http://www.nxp.com>**

For sales offices addresses send e-mail to: **salesaddresses@nxp.com**

© NXP B.V. 2009

All rights are reserved. Reproduction in whole or in part is prohibited without the prior written consent of the copyright owner.

The information presented in this document does not form part of any quotation or contract, is believed to be accurate and reliable and may be changed without notice. No liability will be accepted by the publisher for any consequence of its use. Publication thereof does not convey nor imply any license under patent- or other industrial or intellectual property rights.

Printed in The Netherlands

613514/04/pp9

Date of release: 2003 Mar 25

Document order number: 9397 750 10967

