

## 3.3V, 460 Kbps RS-232 Transceivers

### FEATURES

- Meets true EIA/TIA-232-F Standards from a +3.0V to +5.5V power supply
- Interoperable with RS-232 down to +2.7V power source
- 1 $\mu$ A Low-Power Shutdown with Receivers Active (**SP3222EH**)
- Enhanced ESD Specifications:
  - +15kV Human Body Model
  - +15kV IEC1000-4-2 Air Discharge
  - +8kV IEC1000-4-2 Contact Discharge
- 460Kbps Minimum Transmission Rate
- Ideal for Handheld, Battery Operated Applications

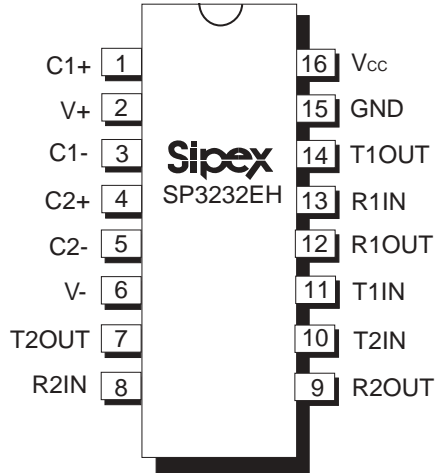

*Now Available in Lead Free Packaging*

### DESCRIPTION

The **SP3222EH** and the **3232EH** are 2 driver/2 receiver RS-232 transceiver solutions intended for portable or hand-held applications such as notebook or palmtop computers. Their data transmission rate of 460Kbps meeting the demands of high speed RS-232 applications. Both ICS have a high-efficiency, charge-pump power supply that requires only 0.1 $\mu$ F capacitors for 3.3V operation. The charge pump allows the **SP3222EH** and the **3232EH** series to deliver true RS-232 performance from a single power supply ranging from +3.3V to +5.0V. The ESD tolerance of the **SP3222EH/3232EH** devices exceeds  $\pm 15$ kV for both Human Body Model and IEC1000-4-2 Air discharge test methods.

The **SP3222EH** device has a low-power shutdown mode where the devices' driver outputs and charge pumps are disabled. During shutdown, the supply current is less than 1 $\mu$ A.

### SELECTION TABLE

MODEL	Power Supplies	RS-232 Drivers	RS-232 Receivers	External Components	Shutdown	TTL 3-State	No. of Pins
SP3222EH	+3.0V to +5.5V	2	2	4	Yes	Yes	18, 20
SP3232EH	+3.0V to +5.5V	2	2	4	No	No	16

## ABSOLUTE MAXIMUM RATINGS

These are stress ratings only and functional operation of the device at these ratings or any other above those indicated in the operation sections of the specifications below is not implied. Exposure to absolute maximum rating conditions for extended periods of time may affect reliability and cause permanent damage to the device.

$V_{CC}$ .....-0.3V to +6.0V  
 $V+$  (NOTE 1).....-0.3V to +7.0V  
 $V-$  (NOTE 1).....+0.3V to -7.0V  
 $V+ + |V-|$  (NOTE 1).....+13V

$I_{CC}$  (DC  $V_{CC}$  or GND current).....±100mA

Electrostatic Discharge

HBM .....15kV  
 IEC1000-4-2-AirDischarge.....15kV  
 IEC1000-4-2 Direct Contact.....8kV

### Input Voltages

$TxIN, \overline{EN}$  .....-0.3V to +6.0V  
 $RxIN$ .....±25V

### Output Voltages

$TxOUT$ .....±13.2V  
 $RxOUT$ .....-0.3V to ( $V_{CC} + 0.3V$ )

### Short-Circuit Duration

$TxOUT$ .....Continuous  
 Storage Temperature.....-65°C to +150°C

### Power Dissipation Per Package

20-pin SSOP (derate 9.25mW/°C above +70°C).....750mW  
 18-pin PDIP (derate 15.2mW/°C above +70°C).....1220mW  
 18-pin SOIC (derate 15.7mW/°C above +70°C).....1260mW  
 20-pin TSSOP (derate 11.1mW/°C above +70°C).....890mW  
 16-pin SSOP (derate 9.69mW/°C above +70°C).....775mW  
 16-pin PDIP (derate 14.3mW/°C above +70°C).....1150mW  
 16-pin Wide SOIC (derate 11.2mW/°C above +70°C).....900mW  
 16-pin TSSOP (derate 10.5mW/°C above +70°C).....850mW

**NOTE 1:**  $V+$  and  $V-$  can have maximum magnitudes of 7V, but their absolute difference cannot exceed 13V.

## ELECTRICAL CHARACTERISTICS

Unless otherwise noted, the following specifications apply for  $V_{CC} = +3.0V$  to +5.0V with  $T_{AMB} = T_{MIN}$  to  $T_{MAX}$

PARAMETER	MIN	TYP	MAX	UNITS	CONDITIONS
<b>DC CHARACTERISTICS</b>					
Supply Current		0.3	1.0	mA	no load, $T_{AMB} = +25^{\circ}C$ , $V_{CC} = +3.3V$ , $TxIN = V_{CC}$ or GND
Shutdown Supply Current		1.0	10	μA	$\overline{SHDN} = GND$ , $T_{AMB} = +25^{\circ}C$ , $V_{CC} = +3.3V$ , $TxIN = V_{CC}$ or GND
<b>LOGIC INPUTS AND RECEIVER OUTPUTS</b>					
Input Logic Threshold LOW			0.8	V	$TxIN, \overline{EN}, \overline{SHDN}$ , Note 2
Input Logic Threshold HIGH	2.0 2.4			V	$V_{CC} = 3.3V$ , Note 2 $V_{CC} = 5.0V$ , Note 2
Input Leakage Current		±0.01	±1.0	μA	$TxIN, \overline{EN}, \overline{SHDN}$ , $T_{AMB} = +25^{\circ}C$
Output Leakage Current		±0.05	±10	μA	receivers disabled
Output Voltage LOW			0.4	V	$I_{OUT} = 1.6mA$
Output Voltage HIGH	$V_{CC} - 0.6$	$V_{CC} - 0.1$		V	$I_{OUT} = -1.0mA$
<b>DRIVER OUTPUTS</b>					
Output Voltage Swing	±5.0	±5.4		V	3kΩ load to ground at all driver outputs, $T_{AMB} = +25^{\circ}C$
Output Resistance	300			Ω	$V_{CC} = V+ = V- = 0V$ , $T_{OUT} = \pm 2V$
Output Short-Circuit Current		±35	±60	mA	$V_{OUT} = 0V$
Output Leakage Current			±25	μA	$V_{OUT} = \pm 12V$ , $V_{CC} = 0V$ or 3.0V+5.5V, drivers disabled

## ELECTRICAL CHARACTERISTICS

Unless otherwise noted, the following specifications apply for  $V_{CC} = +3.0V$  to  $+5.0V$  with  $T_{AMB} = T_{MIN}$  to  $T_{MAX}$ .

PARAMETER	MIN.	TYP.	MAX.	UNITS	CONDITIONS
RECEIVER INPUTS					
Input Voltage Range	-15		+15	V	
Input Threshold LOW	0.6 0.8	1.2 1.5		V	$V_{CC}=3.3V$ $V_{CC}=5.0V$
Input Threshold HIGH		1.5 1.8	2.4 2.4	V	$V_{CC}=3.3V$ $V_{CC}=5.0V$
Input Hysteresis		0.3		V	
Input Resistance	3	5	7	k $\Omega$	
TIMING CHARACTERISTICS					
Maximum Data Rate	460			Kbps	$R_L=3k\Omega$ , $C_L=1000pF$ , one driver switching
Driver Propagation Delay		1.0 1.0		$\mu s$ $\mu s$	$t_{PHL}$ , $R_L = 3K\Omega$ , $C_L = 1000pF$ $t_{PLH}$ , $R_L = 3K\Omega$ , $C_L = 1000pF$
Receiver Propagation Delay		0.3 0.3		$\mu s$	$t_{PHL}$ , RxIN to RxOUT, $C_L=150pF$ $t_{PLH}$ , RxIN to RxOUT, $C_L=150pF$
Receiver Output Enable Time		200		ns	
Receiver Output Disable Time		200		ns	
Driver Skew		100	500	ns	$ t_{PHL} - t_{PLH} $
Receiver Skew		200	1000	ns	$ t_{PHL} - t_{PLH} $
Transition-Region Slew Rate		60		V/ $\mu s$	$V_{CC} = 3.3V$ , $R_L = 3K\Omega$ , $T_{AMB} = 25^\circ C$ , measurements taken from -3.0V to +3.0V or +3.0V to -3.0V

## TYPICAL PERFORMANCE CHARACTERISTICS

Unless otherwise noted, the following performance characteristics apply for  $V_{CC} = +3.3V$ , 460Kbps data rates, all drivers loaded with  $3k\Omega$ ,  $0.1\mu F$  charge pump capacitors, and  $T_{AMB} = +25^{\circ}C$ .

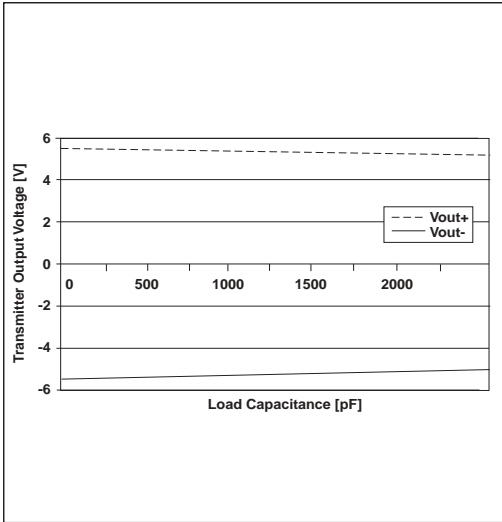

**Figure 1. Transmitter Output Voltage VS. Load Capacitance for the SP3222EH and the SP3232EH**

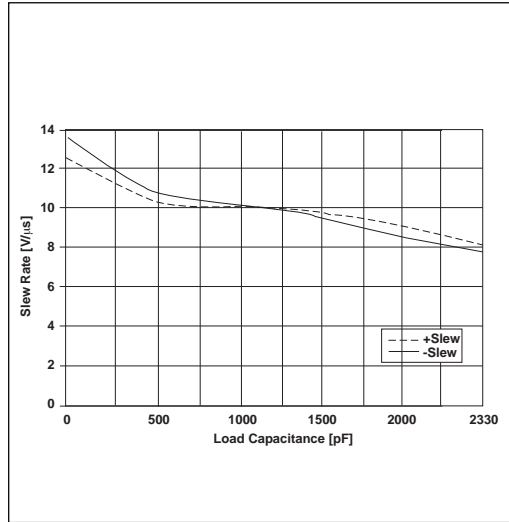

**Figure 2. Slew Rate VS. Load Capacitance for the SP3222EH and the SP3232EH**

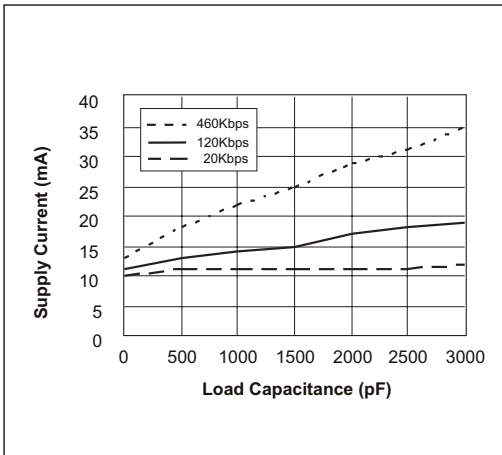

**Figure 3. Supply Current VS. Load Capacitance when Transmitting Data for the SP3222EH and the SP3232EH**

NAME	FUNCTION	PIN NUMBER		
		SP3222EH		SP3232EH
		DIP/SO	SSOP/-TSSOP	
$\overline{\text{EN}}$	Receiver Enable. Apply logic LOW for normal operation. Apply Logic HIGH to disable the receiver outputs (high-Z state).	1	1	-
C1+	Positive terminal of the voltage doubler charge-pump capacitor.	2	2	1
V+	+5.5V generated by the charge pump.	3	3	2
C1-	Negative terminal of the voltage doubler charge-pump capacitor.	4	4	3
C2+	Positive terminal of the inverting charge-pump capacitor.	5	5	4
C2-	Negative terminal of the inverting charge-pump capacitor.	6	6	5
V-	-5.5V generated by the charge pump.	7	7	6
T1OUT	RS-232 driver output.	15	17	14
T2OUT	RS-232 driver output.	8	8	7
R1IN	RS-232 receiver input.	14	16	13
R2IN	RS-232 receiver input.	9	9	8
R1OUT	TTL/CMOS receiver output.	13	15	12
R2OUT	TTL/CMOS receiver output.	10	10	9
T1IN	TTL/CMOS driver input.	12	13	11
T2IN	TTL/CMOS driver input.	11	12	10
GND	Ground.	16	18	15
V <sub>cc</sub>	+3.0V to +5.5V supply voltage	17	19	16
$\overline{\text{SHDN}}$	Shutdown Control Input. Drive HIGH for normal device operation. Drive LOW to shutdown the drivers (high-Z output) and the on-board power supply.	18	20	-
NC	No Connect.	-	11, 14	-

**Table 1. Device Pin Description**

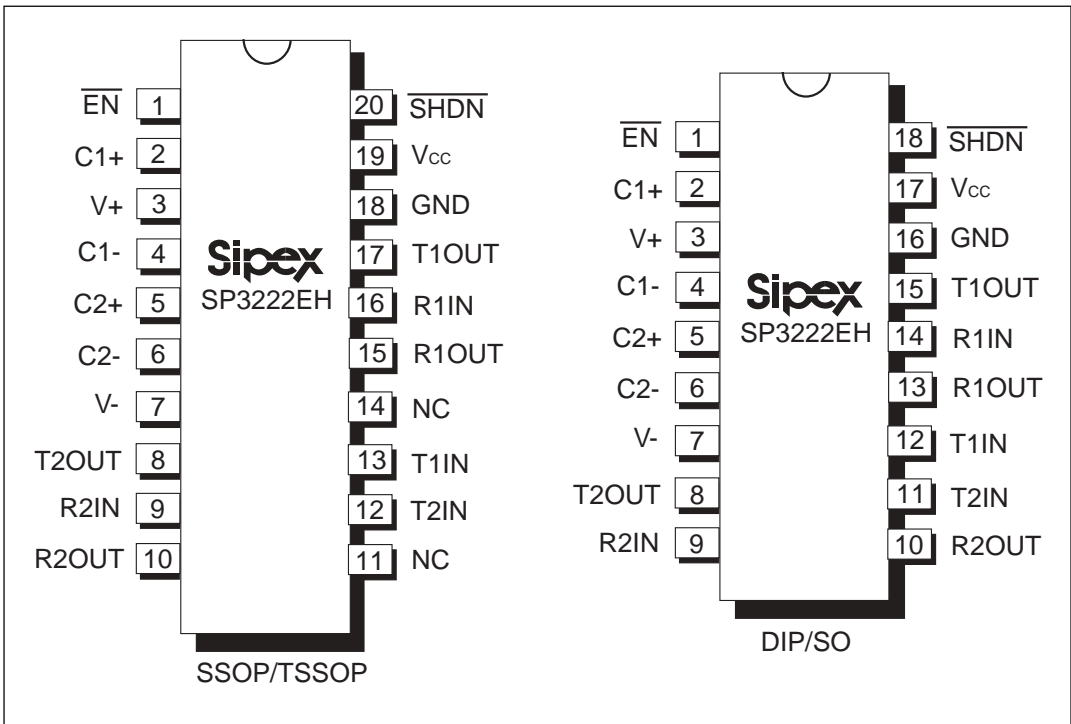

Figure 4. Pinout Configurations for the SP3222EH

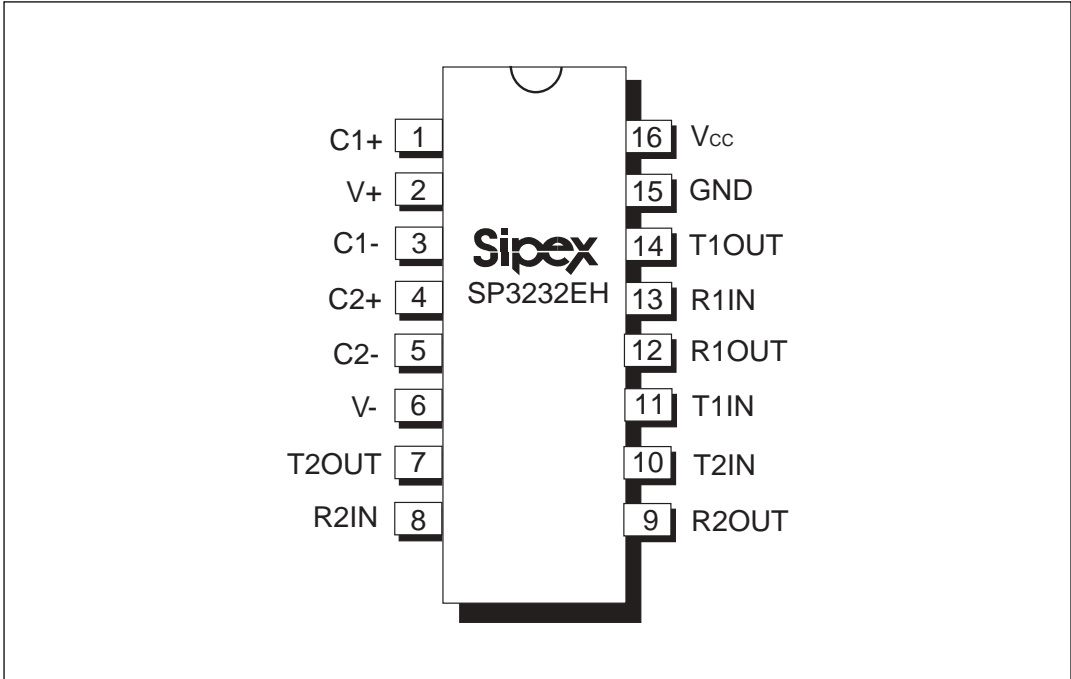

Figure 5. Pinout Configuration for the SP3232EH

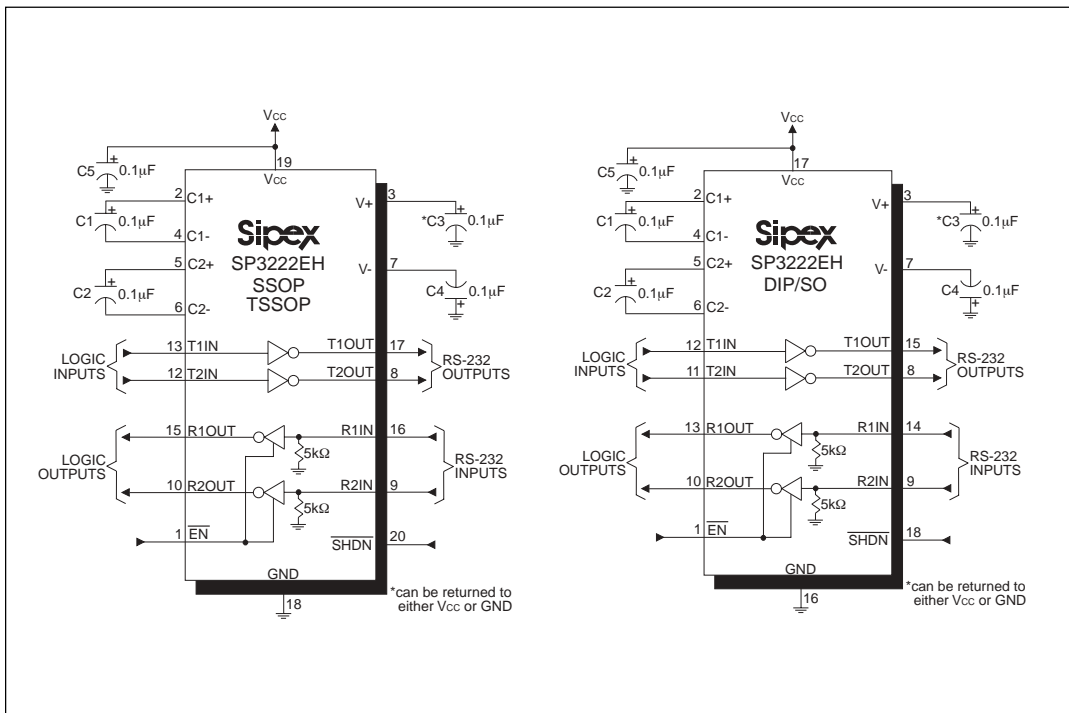

Figure 6. SP3222EH Typical Operating Circuits

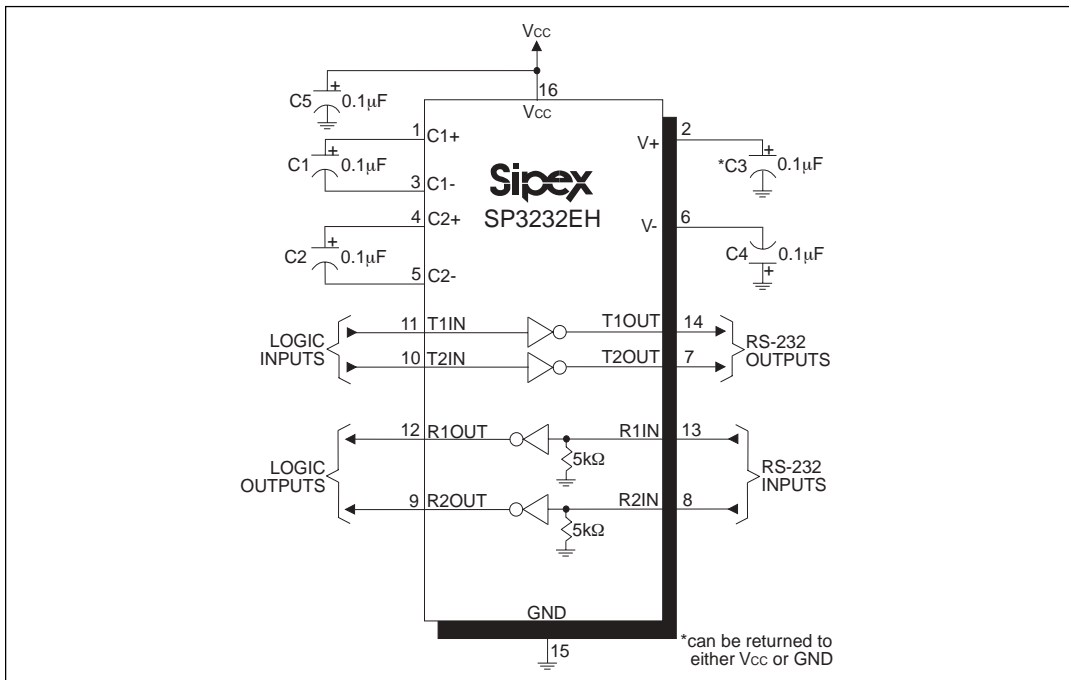

Figure 7. SP3232EH Typical Operating Circuit

## DESCRIPTION

The **SP3222EH** and **SP3232EH** are 2-driver/2-receiver devices ideal for portable or hand-held applications. The **SP3222EH** features a 1 $\mu$ A shutdown mode that reduces power consumption and extends battery life in portable systems. Its receivers remain active in shutdown mode, allowing external devices such as modems to be monitored using only 1 $\mu$ A supply current.

The **SP3222EH/3232EH** transceivers meet the EIA/TIA-232 and V.28/V.24 communication protocols. They feature Sipex's proprietary on-board charge pump circuitry that generates  $2 \times V_{CC}$  for RS-232 voltage levels from a single +3.0V to +5.5V power supply. The **SP3222EH/3232EH** drivers operate at a minimum data rate of 460Kbps.

## THEORY OF OPERATION

The **SP3222EH/3232EH** are made up of three basic circuit blocks: 1. Drivers, 2. Receivers, and 3. the Sipex proprietary charge pump.

### Drivers

The drivers are inverting level transmitters that convert TTL or CMOS logic levels to  $\pm 5.0V$  EIA/TIA-232 levels inverted relative to the input logic levels. Typically, the RS-232 output voltage swing is  $\pm 5.5V$  with no load and at least  $\pm 5V$  minimum fully loaded. The driver outputs are protected against infinite short-circuits to ground without degradation in reliability. Driver outputs will meet EIA/TIA-562 levels of  $\pm 3.7V$  with supply voltages as low as 2.7V.

The drivers have a minimum data rate of 460Kbps fully loaded with 3K $\Omega$  in parallel with 1000pF, ensuring compatibility with PC-to-PC communication software.

The slew rate of the driver output is internally limited to a maximum of 30V/ $\mu$ s in order to meet the EIA standards (EIA RS-232D 2.1.7, Paragraph 5). The transition of the loaded output from HIGH to LOW also meets the monotonicity requirements of the standard.

*Figure 8* shows a loopback circuit used to test the RS-232 drivers. *Figure 9* shows the test results of the loopback circuit with all drivers active at 120Kbps and RS-232 loads in parallel with 1000pF capacitors. *Figure 10* shows the test results where one driver is active at 460Kbps and all drivers are loaded with an RS-232 receiver in parallel with a 1000pF capacitor.

The **SP3222EH** driver's output stages are tri-stated in shutdown mode. When the power is off, the **SP3222EH** device permits the outputs to be driven up to  $\pm 12V$ . Because the driver's inputs do not have pull-up resistors, unused inputs should be connected to  $V_{CC}$  or GND.

In the shutdown mode, the supply current is less than 1 $\mu$ A, where  $\overline{SHDN} = \text{LOW}$ . When the **SP3222EH** device is shut down, the device's driver outputs are disabled (tri-stated) and the charge pumps are turned off with  $V_+$  pulled down to  $V_{CC}$  and  $V_-$  pulled to GND. The time required to exit shutdown is typically 100 $\mu$ s.  $\overline{SHDN}$  is connected to  $V_{CC}$  if the shutdown mode is not used.  $\overline{SHDN}$  has no effect on RxOUT or RxOUTB. As they become active, the two driver outputs go to opposite RS-232 levels: one driver input is HIGH and the other LOW. Note that the drivers are enabled only when the magnitude of  $V_-$  exceeds approximately 3V.



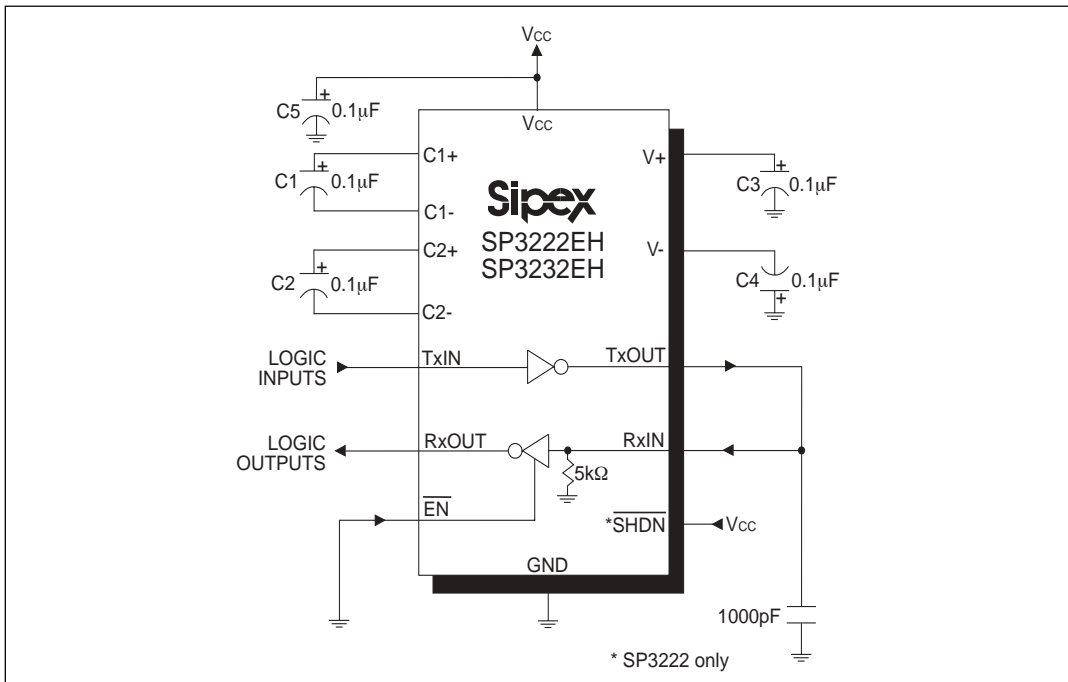

Figure 8. SP3222EH/3232EH Driver Loopback Test Circuit

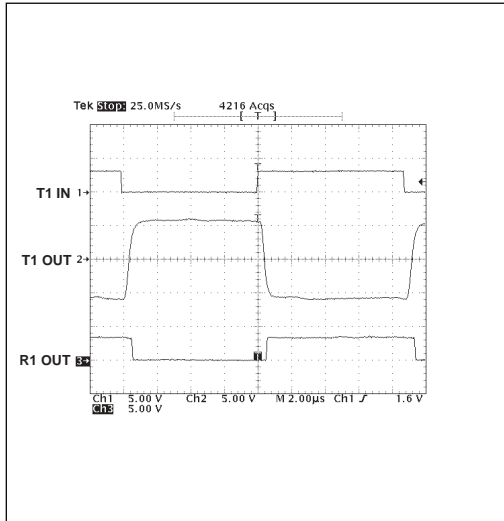

Figure 9. Driver Loopback Test Results at 120Kbps

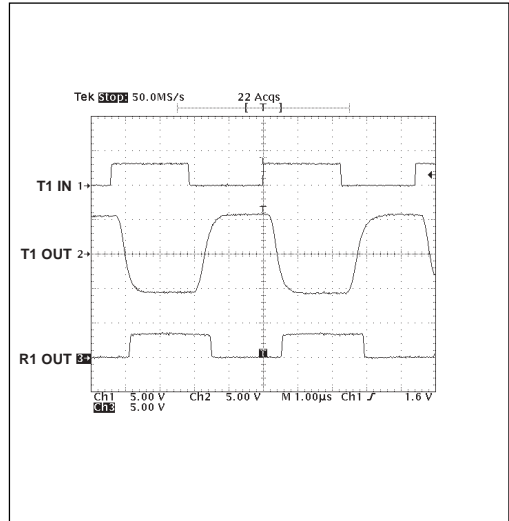

Figure 10. Driver Loopback Test Results at 460Kbps

## Receivers

The receivers convert EIA/TIA-232 levels to TTL or CMOS logic output levels. The SP3222EH receivers have an inverting tri-state output. Receiver outputs (RxOUT) are tri-stated when the enable control  $\overline{EN} = \text{HIGH}$ . In the shutdown mode, the receivers can be active or inactive.  $\overline{EN}$  has no effect on TxOUT. The truth table logic of the **SP3222EH** driver and receiver outputs can be found in *Table 2*.

Since receiver input is usually from a transmission line where long cable lengths and system interference can degrade the signal and inject noise, the inputs have a typical hysteresis margin of 300mV. Should an input be left unconnected, a 5k $\Omega$  pulldown resistor to ground forces the output of the receiver HIGH.

## Charge Pump

The **Sipex** patented charge pump (5,306,954) uses a four-phase voltage shifting technique to attain symmetrical 5.5V power supplies and requires four external capacitors. The internal power supply consists of a regulated dual charge pump that provides an output voltage of 5.5V regardless of the input voltage ( $V_{CC}$ ) over the +3.0V to +5.5V range.

$\overline{\text{SHDN}}$	$\overline{\text{EN}}$	TxOUT	RxOUT
0	0	Tri-state	Active
0	1	Tri-state	Tri-state
1	0	Active	Active
1	1	Active	Tri-state

*Table 2. Truth Table Logic for Shutdown and Enable Control*

In most circumstances, decoupling the power supply can be achieved adequately using a 0.1 $\mu\text{F}$  bypass capacitor at C5 (refer to *Figures 6* and *7*). In applications that are sensitive to power-supply noise,  $V_{CC}$  and ground can be decoupled with a capacitor of the same value as charge-pump capacitor C1. It is always important to physically locate bypass capacitors close to the IC.

The charge pump operates in a discontinuous mode using an internal oscillator. If the output voltage is less than 5.5V, the charge pump is enabled. If the output voltage exceeds 5.5V, the charge pump is disabled. An oscillator controls the four phases of the voltage shifting. A description of each phase follows.

### Phase 1: $V_{SS}$ Charge Storage (*Figure 12*)

During this phase of the clock cycle, the positive side of capacitors  $C_1$  and  $C_2$  are charged to  $V_{CC}$ .  $C_1^+$  is then switched to GND and the charge in  $C_1^-$  is transferred to  $C_2^-$ . Since  $C_2^+$  is connected to  $V_{CC}$ , the voltage potential across capacitor  $C_2$  is now 2 times  $V_{CC}$ .

### Phase 2: $V_{SS}$ Transfer (*Figure 13*)

Phase two of the clock connects the negative terminal of  $C_2$  to the  $V_{SS}$  storage capacitor and the positive terminal of  $C_2$  to GND. This transfers a negative generated voltage to  $C_3$ . This generated voltage is regulated to a minimum voltage of -5.5V. Simultaneous with the transfer of the voltage to  $C_3$ , the positive side of capacitor  $C_1$  is switched to  $V_{CC}$  and the negative side is connected to GND.

### Phase 3: $V_{DD}$ Charge Storage (*Figure 15*)

The third phase of the clock is identical to the first phase — the charge transferred in  $C_1$  produces  $-V_{CC}$  in the negative terminal of  $C_1$ , which is applied to the negative side of capacitor  $C_2$ . Since  $C_2^+$  is at  $V_{CC}$ , the voltage potential across  $C_2$  is 2 times  $V_{CC}$ .

#### Phase 4: $V_{DD}$ Transfer (Figure 16)

The fourth phase of the clock connects the negative terminal of  $C_2$  to GND, and transfers this positive generated voltage across  $C_2$  to  $C_4$ , the  $V_{DD}$  storage capacitor. This voltage is regulated to +5.5V. At this voltage, the internal oscillator is disabled. Simultaneous with the transfer of the voltage to  $C_4$ , the positive side of capacitor  $C_1$  is switched to  $V_{CC}$  and the negative side is connected to GND, allowing the charge pump cycle to repeat. The charge pump cycle will continue as long as the operational conditions for the internal oscillator are present.

Since both  $V^+$  and  $V^-$  are separately generated from  $V_{CC}$ ; in a no-load condition  $V^+$  and  $V^-$  will be symmetrical. Older charge pump approaches that generate  $V^-$  from  $V^+$  will show a decrease in the magnitude of  $V^-$  compared to  $V^+$  due to the inherent inefficiencies in the design.

The charge pump clock rate typically operates at 250kHz. The external capacitors can be as low as 0.1 $\mu$ F with a 16V breakdown voltage rating.

#### ESD Tolerance

The **SP3222EH/3232EH** series incorporates ruggedized ESD cells on all driver output and receiver input pins. The improved ESD tolerance is at least  $\pm 15$ kV without damage or latch-up.

Three methods of ESD testing are performed:

- a) MIL-STD-883, Method 3015.7
- b) IEC1000-4-2 Air-Discharge
- c) IEC1000-4-2 Direct Contact

The Human Body Model has been the generally accepted ESD testing method for semiconductors. This method is also specified in MIL-STD-883, Method 3015.7 for ESD testing. The premise of this ESD test is to simulate the human body's potential to store electro-static energy and

discharge it to an integrated circuit. The simulation is performed by using a test model as shown in *Figure 17*. This method will test the IC's capability to withstand an ESD transient during normal handling such as in manufacturing areas where the ICs tend to be handled frequently.

The IEC-1000-4-2, formerly IEC801-2, is used for testing ESD on equipment and systems. For system manufacturers, they must guarantee a certain amount of ESD protection since the system itself is exposed to the outside environment and human presence. The premise with IEC1000-4-2 is that the system is required to withstand an amount of static electricity when ESD is applied to points and surfaces of the equipment that are accessible to personnel during normal usage. In many cases, the RS232 transceiver IC receives most of the ESD current when the ESD source is applied to the connector pins. The test circuit for IEC1000-4-2 is shown on *Figure 18*. There are two methods within IEC1000-4-2, the Air Discharge method and the Contact Discharge method.

With the Air Discharge Method, an ESD voltage is applied to the equipment under test (EUT) through air. This simulates an electrically charged person ready to connect a cable onto the rear of the system. The high energy potential on the person discharges through an arcing path to the rear panel of the system before he or she touches the system. This energy, whether discharged directly or through air, is predominantly a function of the discharge current rather than the discharge voltage. Variables with an air discharge such as approach speed of the object carrying the ESD potential to the system and humidity will tend to change the discharge current. For example, the rise time of the discharge current varies with the approach speed.

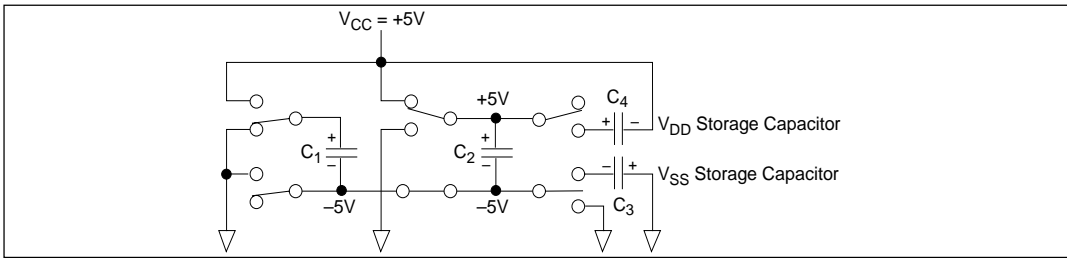

Figure 12. Charge Pump — Phase 1

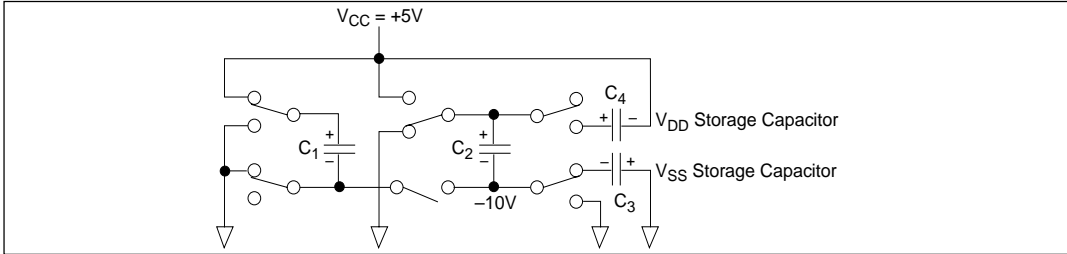

Figure 13. Charge Pump — Phase 2

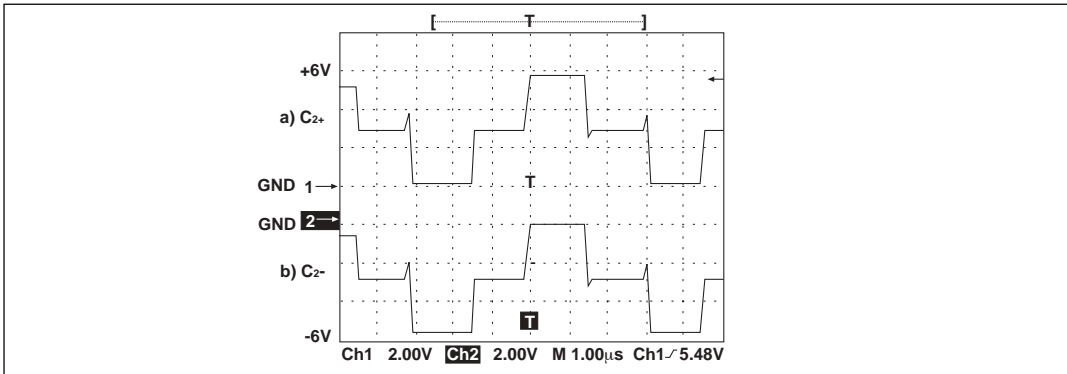

Figure 14. Charge Pump Waveforms

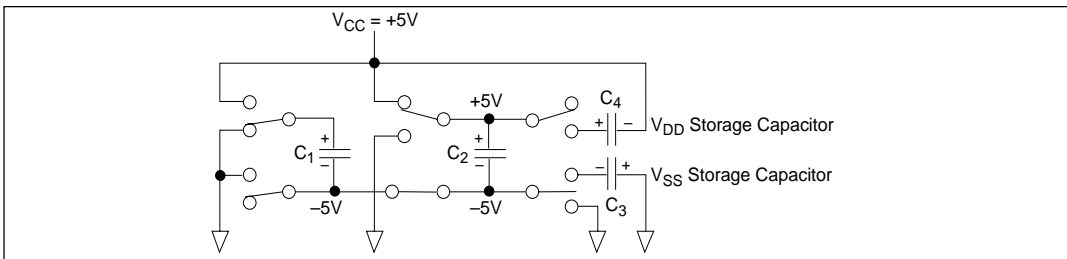

Figure 15. Charge Pump — Phase 3

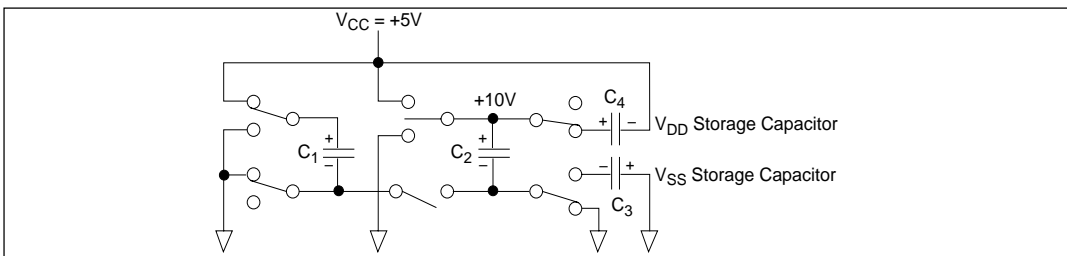

Figure 16. Charge Pump — Phase 4

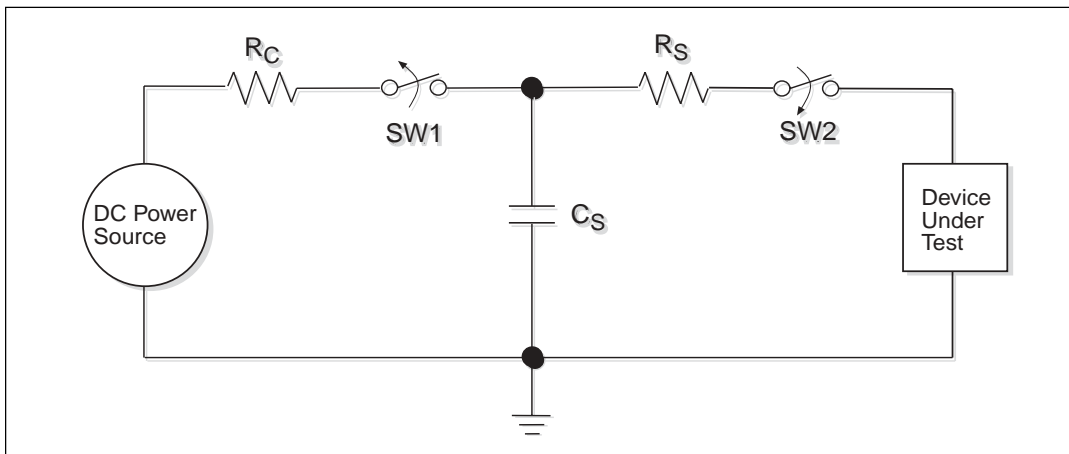

Figure 17. ESD Test Circuit for Human Body Model

The Contact Discharge Method applies the ESD current directly to the EUT. This method was devised to reduce the unpredictability of the ESD arc. The discharge current rise time is constant since the energy is directly transferred without the air-gap arc. In situations such as hand held systems, the ESD charge can be directly discharged to the equipment from a person already holding the equipment. The current is transferred on to the keypad or the serial port of the equipment directly and then travels through the PCB and finally to the IC.

The circuit models in Figures 17 and 18 represent the typical ESD testing circuits used for all three methods. The  $C_S$  is initially charged with the DC power supply when the first switch (SW1) is on. Now that the capacitor is charged, the second switch (SW2) is on while SW1 switches off. The voltage stored in the capacitor is then applied through  $R_S$ , the current limiting resistor, onto the device under test (DUT). In ESD tests, the SW2 switch is pulsed so that the device under test receives a duration of voltage.

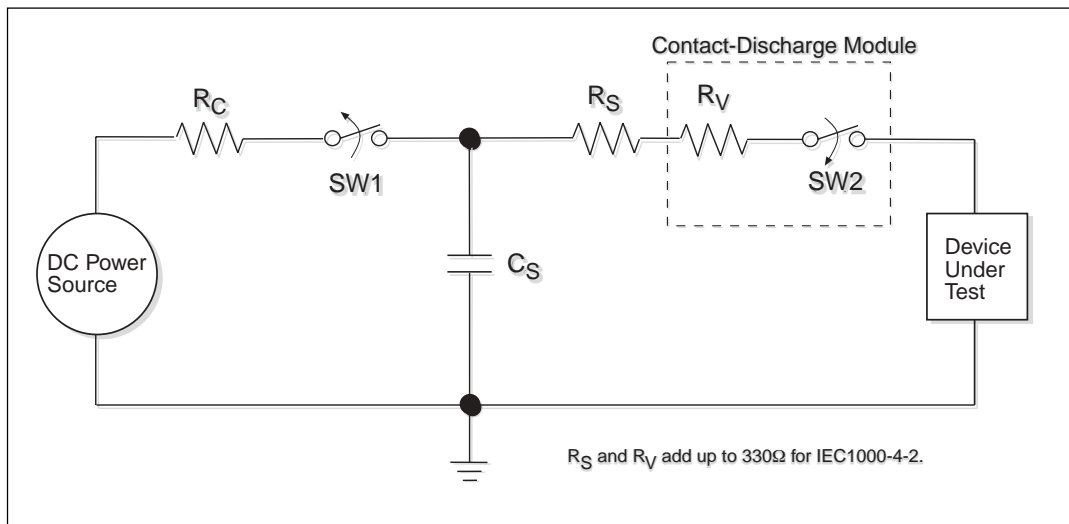

Figure 18. ESD Test Circuit for IEC1000-4-2

For the Human Body Model, the current limiting resistor ( $R_s$ ) and the source capacitor ( $C_s$ ) are  $1.5k\Omega$  and  $100pF$ , respectively. For IEC-1000-4-2, the current limiting resistor ( $R_s$ ) and the source capacitor ( $C_s$ ) are  $330\Omega$  and  $150pF$ , respectively.

The higher  $C_s$  value and lower  $R_s$  value in the IEC1000-4-2 model are more stringent than the Human Body Model. The larger storage capacitor injects a higher voltage to the test point when SW2 is switched on. The lower current limiting resistor increases the current charge onto the test point.

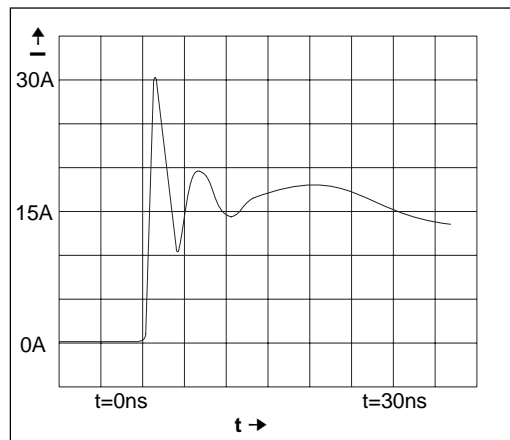
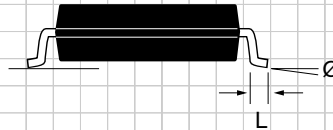
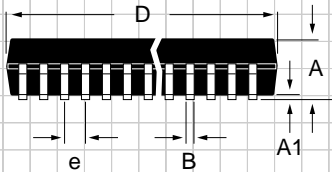
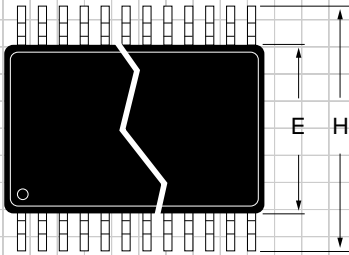

Figure 19. ESD Test Waveform for IEC1000-4-2

Device Pin Tested	Human Body Model	IEC1000-4-2		
		Air Discharge	Direct Contact	Level
Driver Outputs	$\pm 15kV$	$\pm 15kV$	$\pm 8kV$	4
Receiver Inputs	$\pm 15kV$	$\pm 15kV$	$\pm 8kV$	4

Table 3. Transceiver ESD Tolerance Levels

**PACKAGE: PLASTIC SHRINK  
SMALL OUTLINE  
(SSOP)**



DIMENSIONS (Inches) Minimum/Maximum (mm)	16-PIN	20-PIN	24-PIN	28-PIN
A	0.068/0.078 (1.73/1.99)	0.068/0.078 (1.73/1.99)	0.068/0.078 (1.73/1.99)	0.068/0.078 (1.73/1.99)
A1	0.002/0.008 (0.05/0.21)	0.002/0.008 (0.05/0.21)	0.002/0.008 (0.05/0.21)	0.002/0.008 (0.05/0.21)
B	0.010/0.015 (0.25/0.38)	0.010/0.015 (0.25/0.38)	0.010/0.015 (0.25/0.38)	0.010/0.015 (0.25/0.38)
D	0.239/0.249 (6.07/6.33)	0.278/0.289 (7.07/7.33)	0.317/0.328 (8.07/8.33)	0.397/0.407 (10.07/10.33)
E	0.205/0.212 (5.20/5.38)	0.205/0.212 (5.20/5.38)	0.205/0.212 (5.20/5.38)	0.205/0.212 (5.20/5.38)
e	0.0256 BSC (0.65 BSC)	0.0256 BSC (0.65 BSC)	0.0256 BSC (0.65 BSC)	0.0256 BSC (0.65 BSC)
H	0.301/0.311 (7.65/7.90)	0.301/0.311 (7.65/7.90)	0.301/0.311 (7.65/7.90)	0.301/0.311 (7.65/7.90)
L	0.022/0.037 (0.55/0.95)	0.022/0.037 (0.55/0.95)	0.022/0.037 (0.55/0.95)	0.022/0.037 (0.55/0.95)
Ø	0°/8° (0°/8°)	0°/8° (0°/8°)	0°/8° (0°/8°)	0°/8° (0°/8°)

# PACKAGE: PLASTIC DUAL-IN-LINE (NARROW)

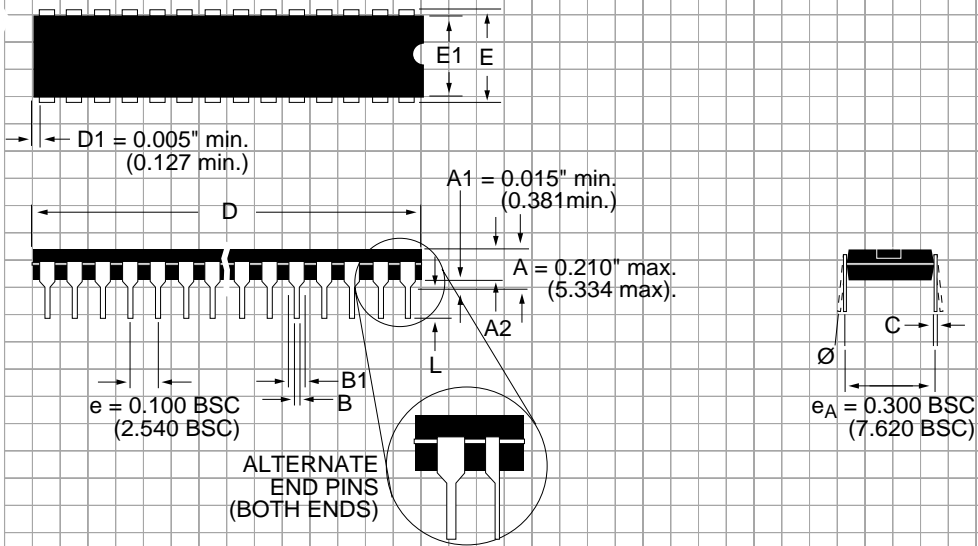

DIMENSIONS (Inches) Minimum/Maximum (mm)	16-PIN	18-PIN
A2	0.115/0.195 (2.921/4.953)	0.115/0.195 (2.921/4.953)
B	0.014/0.022 (0.356/0.559)	0.014/0.022 (0.356/0.559)
B1	0.045/0.070 (1.143/1.778)	0.045/0.070 (1.143/1.778)
C	0.008/0.014 (0.203/0.356)	0.008/0.014 (0.203/0.356)
D	0.780/0.800 (19.812/20.320)	0.880/0.920 (22.352/23.368)
E	0.300/0.325 (7.620/8.255)	0.300/0.325 (7.620/8.255)
E1	0.240/0.280 (6.096/7.112)	0.240/0.280 (6.096/7.112)
L	0.115/0.150 (2.921/3.810)	0.115/0.150 (2.921/3.810)
$\emptyset$	0°/ 15° (0°/15°)	0°/ 15° (0°/15°)



**PACKAGE: PLASTIC  
SMALL OUTLINE (SOIC)**

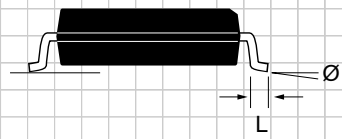
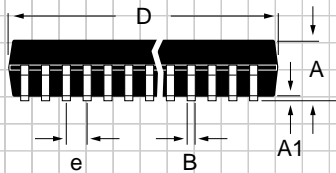
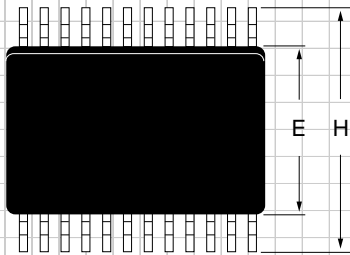

DIMENSIONS (Inches) Minimum/Maximum (mm)	16-PIN	18-PIN
A	0.090/0.104 (2.29/2.649)	0.090/0.104 (2.29/2.649)
A1	0.004/0.012 (0.102/0.300)	0.004/0.012 (0.102/0.300)
B	0.013/0.020 (0.330/0.508)	0.013/0.020 (0.330/0.508)
D	0.398/0.413 (10.10/10.49)	0.447/0.463 (11.35/11.74)
E	0.291/0.299 (7.402/7.600)	0.291/0.299 (7.402/7.600)
e	0.050 BSC (1.270 BSC)	0.050 BSC (1.270 BSC)
H	0.394/0.419 (10.00/10.64)	0.394/0.419 (10.00/10.64)
L	0.016/0.050 (0.406/1.270)	0.016/0.050 (0.406/1.270)
Ø	0°/8° (0°/8°)	0°/8° (0°/8°)

# PACKAGE: PLASTIC THIN SMALL OUTLINE (TSSOP)

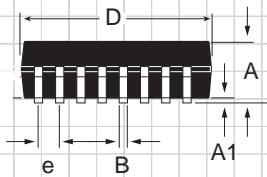
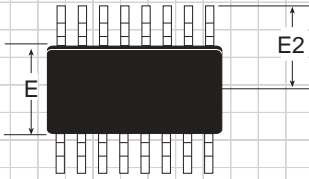

DIMENSIONS in inches (mm) Minimum/Maximum	16-PIN	20-PIN
A	- /0.043 (- /1.10)	- /0.043 (- /1.10)
A1	0.002/0.006 (0.05/0.15)	0.002/0.006 (0.05/0.15)
B	0.007/0.012 (0.19/0.30)	0.007/0.012 (0.19/0.30)
D	0.193/0.201 (4.90/5.10)	0.252/0.260 (6.40/6.60)
E	0.169/0.177 (4.30/4.50)	0.169/0.177 (4.30/4.50)
e	0.026 BSC (0.65 BSC)	0.026 BSC (0.65 BSC)
E2	0.126 BSC (3.20 BSC)	0.126 BSC (3.20 BSC)
L	0.020/0.030 (0.50/0.75)	0.020/0.030 (0.50/0.75)
Ø	0°/8°	0°/8°

<b>Part Number</b>	<b>Temperature Range</b>	<b>Package Type</b>
SP3222EHCA .....	0°C to +70°C .....	20-Pin SSOP
SP3222EHCA/TR .....	0°C to +70°C .....	20-Pin SSOP
SP3222EHEA .....	-40°C to +85°C .....	20-Pin SSOP
SP3222EHEA/TR .....	-40°C to +85°C .....	20-Pin SSOP
SP3222EHCP .....	0°C to +70°C .....	18-Pin PDIP
SP3222EHEP .....	-40°C to +85°C .....	18-Pin PDIP
SP3222EHCT .....	0°C to +70°C .....	18-Pin WSOIC
SP3222EHCT/TR .....	0°C to +70°C .....	18-Pin WSOIC
SP3222EHET .....	-40°C to +85°C .....	18-Pin WSOIC
SP3222EHET/TR .....	-40°C to +85°C .....	18-Pin WSOIC
SP3222EHCY .....	0°C to +70°C .....	20-Pin TSSOP
SP3222EHCY/TR .....	0°C to +70°C .....	20-Pin TSSOP
SP3222EHEY .....	-40°C to +85°C .....	20-Pin TSSOP
SP3222EHEY/TR .....	-40°C to +85°C .....	20-Pin TSSOP
SP3232EHCA .....	0°C to +70°C .....	16-Pin SSOP
SP3232EHCA/TR .....	0°C to +70°C .....	16-Pin SSOP
SP3232EHEA .....	-40°C to +85°C .....	16-Pin SSOP
SP3232EHEA/TR .....	-40°C to +85°C .....	16-Pin SSOP
SP3232EHCP .....	0°C to +70°C .....	16-Pin PDIP
SP3232EHEP .....	-40°C to +85°C .....	16-Pin PDIP
SP3232EHCT .....	0°C to +70°C .....	16-Pin WSOIC
SP3232EHCT/TR .....	0°C to +70°C .....	16-Pin WSOIC
SP3232EHET .....	-40°C to +85°C .....	16-Pin WSOIC
SP3232EHET/TR .....	-40°C to +85°C .....	16-Pin WSOIC
SP3232EHCY .....	0°C to +70°C .....	16-Pin TSSOP
SP3232EHCY/TR .....	0°C to +70°C .....	16-Pin TSSOP
SP3232EHEY .....	-40°C to +85°C .....	16-Pin TSSOP
SP3232EHEY/TR .....	-40°C to +85°C .....	16-Pin TSSOP

Available in lead free packaging. To order add "-L" suffix to part number.

Example: SP3232EHEY/TR = standard; SP3232EHEY-L/TR = lead free

/TR = Tape and Reel

Pack quantity is 1,500 for WSOIC, SSOP and TSSOP.



**ANALOG EXCELLENCE**

**Sipex Corporation**

**Headquarters and  
Sales Office**

233 South Hillview Drive  
Milpitas, CA 95035  
TEL: (408) 934-7500  
FAX: (408) 935-7600

Sipex Corporation reserves the right to make changes to any products described herein. Sipex does not assume any liability arising out of the application or use of any product or circuit described hereing; neither does it convey any license under its patent rights nor the rights of others.