

## 150mA, Low-Noise LDO Voltage Regulator

### FEATURES

- Low Noise Output LDO: 40 $\mu$ V<sub>RMS</sub> Possible
- 1% Initial Accuracy
- Very Low Quiescent Current: 70 $\mu$ A
- Low Dropout Voltage (210mV at 150mA)
- Current and Thermal Limiting
- Reverse-Battery Protection
- Wide Range of Fix Output Voltages: 1.2V, 1.5V, 1.8V, 2.0V, 2.5V, 2.8V, 3.0V, 3.3V and 5.0V
- Zero Off-Mode Current
- Small 5-Pin SOT-23
- Pin Compatible to MIC5205/MAX8877 (fixed Options Only) and AS3815

### APPLICATIONS

- PDA
- Battery Powered Systems
- Cellular Phone
- Cordless Telephones
- Radio Control Systems
- Laptop, Palmtop, and Notebook Computers
- Portable Consumer Equipment
- Portable Instrumentation
- Bar Code Scanners
- SMPS Post-Regulator

#### Fixed Output Voltage

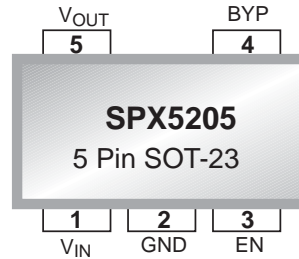

#### Adjustable Output Voltage

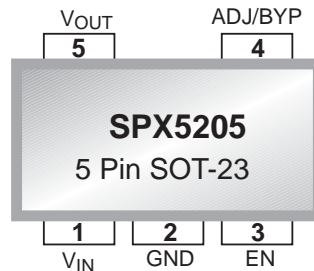

### DESCRIPTION

The SPX5205 is a positive voltage regulator with very low dropout voltage, output noise and ground current (750 $\mu$ A at 100mA).  $V_{OUT}$  has a tolerance of less than 1% and is temperature compensated. Fixed output voltages 1.2V, 1.5V, 1.8V, 2.0V, 2.5V, 2.8V, 3.0V, 3.3V, and 5.0V and an adjustable version are available in a small 5-pin SOT-23 package. Other key features include zero off-mode current, reverse battery protection, thermal shutdown and current limit. The SPX5205 is an excellent choice for use in battery-powered applications, and where power conservation is desired such as: cellular/ cordless telephones, radio control systems, and portable computers.

### TYPICAL APPLICATION CIRCUIT

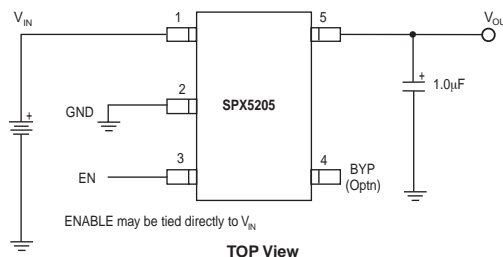

## ABSOLUTE MAXIMUM RATINGS

Thermal Shutdown ..... Internally Limited  
 Lead Temperature (Soldering, 5 seconds) ..... 260°C  
 Operating Junction Temperature Range ..... -40°C to +125°C

Input Supply Voltage ..... -20V to +20V  
 Enable Input Voltage ..... -20V to +20V

## RECOMMENDED OPERATING CONDITIONS

Input voltage ..... +2.5V to 16V  
 Operating Junction Temperature Range ..... -40°C to +125°C  
 Enable Input Voltage ..... 0V to  $V_{IN}$   
 SOT-23-5 ( $\theta_{JA}$ ) ..... See Note 1

## ELECTRICAL CHARACTERISTICS

$T_J=25^\circ\text{C}$ ,  $V_{IN} = V_{OUT} + 1\text{V}$ ,  $I_L = 100\mu\text{A}$ ,  $C_L = 1\mu\text{F}$ , and  $V_{ENABLE} \geq 2.4\text{V}$ . The  $\blacklozenge$  denotes the specifications which apply over full temperature range -40°C to +85°C, unless otherwise specified.

PARAMETER	MIN	TYP	MAX	UNITS	CONDITIONS
Output Voltage Tolerance ( $V_{OUT}$ )	-1 -2		+1 +2	% $V_{NOM}$	$\blacklozenge$
Output Voltage Temperature Coefficient		57		ppm/°C	$\blacklozenge$
Line Regulation		0.03	0.1 0.2	%/V	$\blacklozenge$ $V_{IN} = V_{OUT} + 1\text{V}$ to 16V
Load Regulation		0.1	0.2 0.5	%	$\blacklozenge$ $I_L = 0.1\text{mA}$ to 150mA
Dropout Voltage (See Note 2) ( $V_{IN} - V_O$ )		30	50 70	mV	$\blacklozenge$ $I_L = 100\mu\text{A}$
		140	190 230	mV	$\blacklozenge$ $I_L = 50\text{mA}$
		180	250 300	mV	$\blacklozenge$ $I_L = 100\text{mA}$
		210	275 350	mV	$\blacklozenge$ $I_L = 150\text{mA}$
Quiescent Current ( $I_{GND}$ )		0.05	1 5	$\mu\text{A}$	$\blacklozenge$ $V_{ENABLE} \leq 0.4\text{V}$ $V_{ENABLE} \leq 0.25\text{V}$
Ground Pin Current ( $I_{GND}$ )		70	125 150	$\mu\text{A}$	$\blacklozenge$ $I_L = 100\mu\text{A}$
		350	600 800		$\blacklozenge$ $I_L = 50\text{mA}$
		750	1000 1500		$\blacklozenge$ $I_L = 100\text{mA}$
		1300	1900 2500		$\blacklozenge$ $I_L = 150\text{mA}$
Ripple Rejection (PSRR)		70		dB	
Current Limit ( $I_{LIMIT}$ )		360	500	mA	$V_{OUT} = 0\text{V}$
Output Noise ( $e_{NO}$ )		300		$\mu\text{V}_{RMS}$	$\blacklozenge$ $I_L = 10\text{mA}$ , $C_L = 1\mu\text{F}$ , $C_{IN} = 1\mu\text{F}$ (10Hz - 100kHz.)
		40		$\mu\text{V}_{RMS}$	$\blacklozenge$ $I_L = 10\text{mA}$ , $C_L = 10\mu\text{F}$ , $C_{BYP} = 1\mu\text{F}$ , $C_{IN} = 1\mu\text{F}$ , (10Hz - 100kHz)
Input Voltage Level Logic Low ( $V_{IL}$ )			0.4	V	OFF
Input Voltage Level Logic High ( $V_{IH}$ )	2.0				ON
ENABLE Input Current		0.01 3	2 20	$\mu\text{A}$	$\blacklozenge$ $V_{IL} \leq 0.4\text{V}$ $V_{IH} \geq 2.0\text{V}$

**Note 1:** The maximum allowable power dissipation is a function of maximum operating junction temperature,  $T_{J(max)}$ , the junction to ambient thermal resistance, and the ambient,  $\theta_{JA}$ , and the ambient temperature  $T_A$ . The maximum allowable power dissipation at any ambient temperature is given:  $P_{D(max)} = (T_{J(max)} - T_A)/\theta_{JA}$ , exceeding the maximum allowable power limit will result in excessive die temperature; thus, the regulator will go into thermal shutdown. The  $\theta_{JA}$  of the SPX5205 is 220°C/W mounted on a PC board.

**Note 2:** Not applicable to output voltages of less than 2V.

# TYPICAL PERFORMANCE CHARACTERISTICS

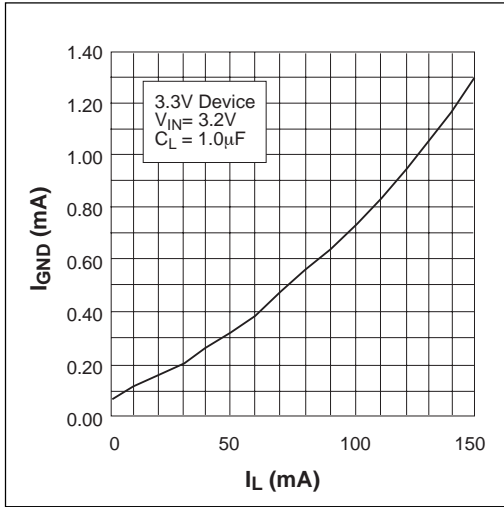

Ground Current vs Load Current

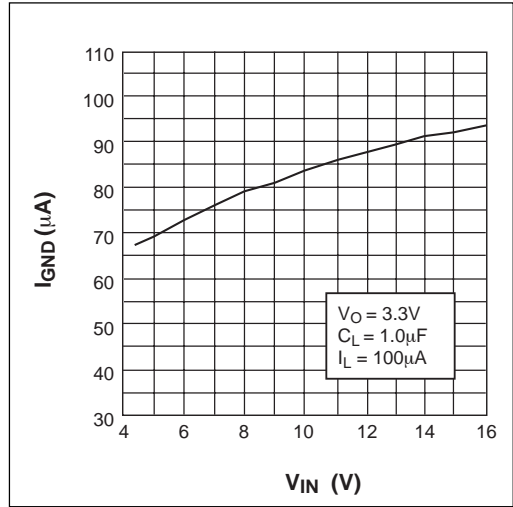

Ground Current vs Input Voltage

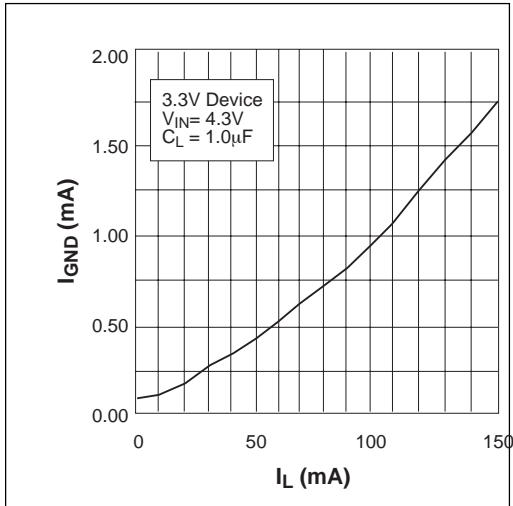

Ground Current vs Load Current in Dropout

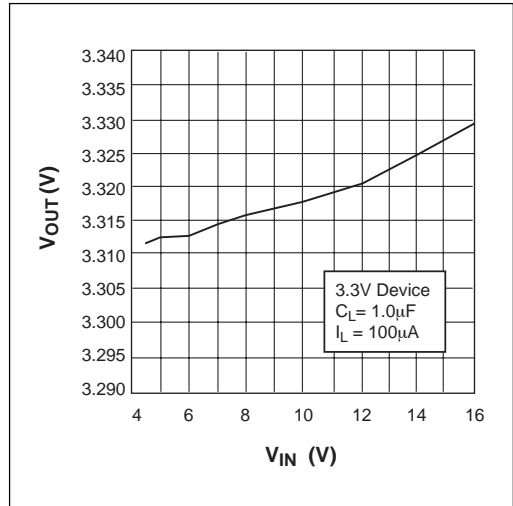

Output Voltage vs Input Voltage

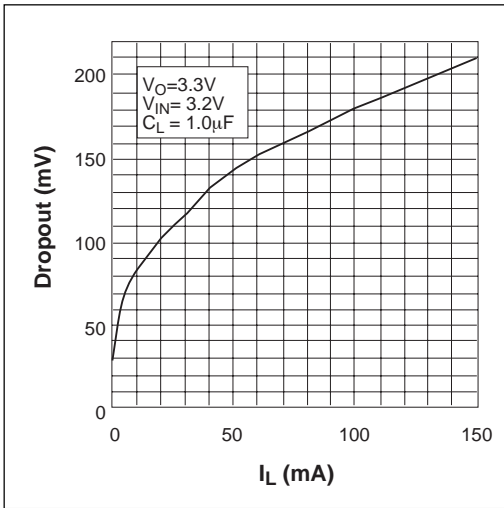

Dropout Voltage vs Load Current

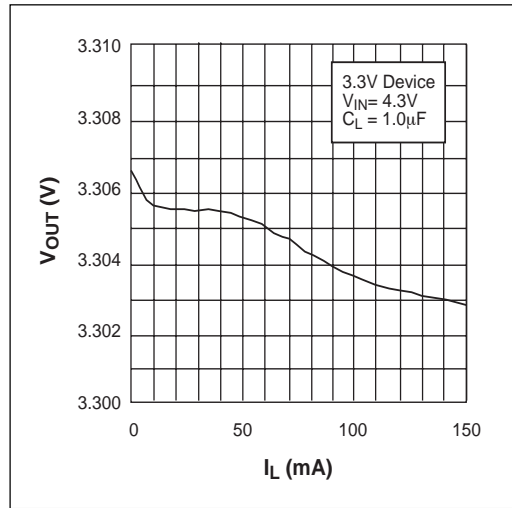

Output Voltage vs Load Current

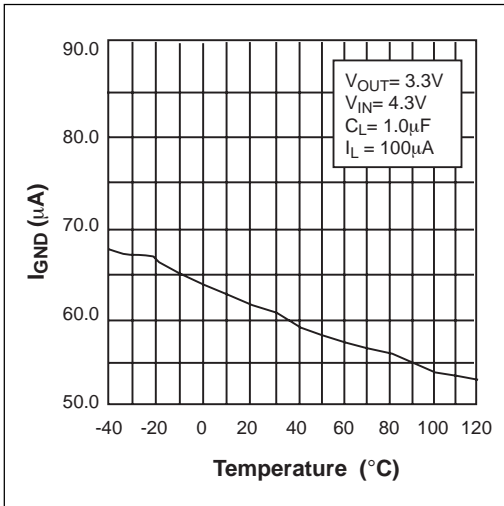

Ground Current vs Temperature at  $I_{LOAD}=100\mu A$

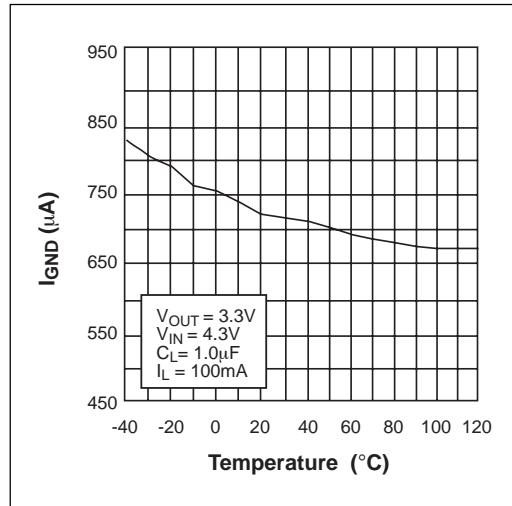

Ground Current vs Temperature at  $I_{LOAD}=100mA$

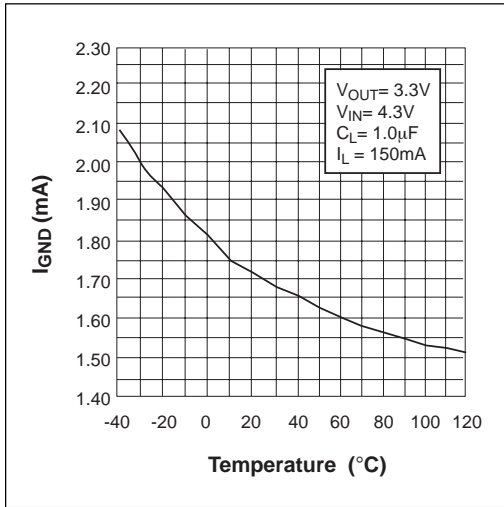

Ground Current in Dropout vs Temperature

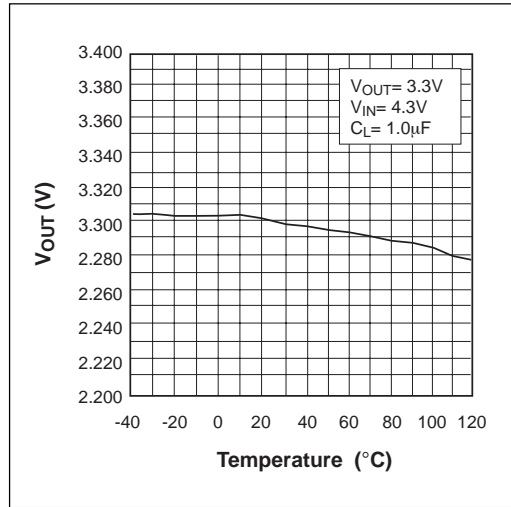

Output Voltage vs Temperature

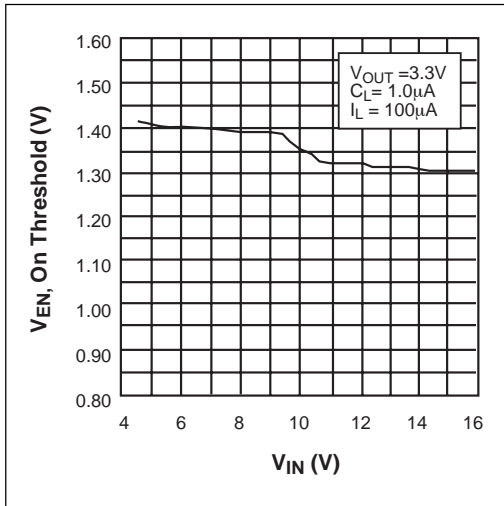

ENABLE Voltage, ON threshold vs Input Voltage

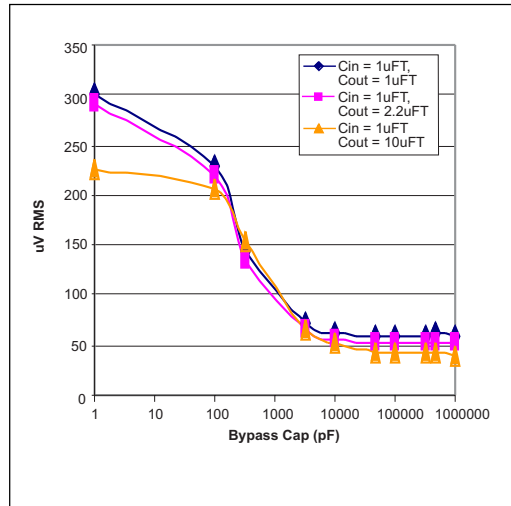

Output Noise vs. Bypass Capacitor Value

The SPX5205 requires an output capacitor for device stability. Its value depends upon the application circuit. In general, linear regulator stability decreases with higher output currents. In applications where the SPX5205 is putting out less current, a lower output capacitance may be sufficient. For example, a regulator sourcing only 10mA, requires approximately half the capacitance as the same regulator sourcing 150mA.

Bench testing is the best method for determining the proper type and value of the capacitor since the high frequency characteristics of electrolytic capacitors vary widely, depending on type and manufacturer. A high quality 2.2 $\mu$ F aluminum electrolytic capacitor works in most application circuits, but the same stability often can be obtained with a 1 $\mu$ F tantalum electrolytic.

With the SPX5205 adjustable version, the minimum value of output capacitance is a function of the output voltage. The value decreases with higher output voltages, since closed loop gain is increased.

### Typical Applications Circuits

A 10nF capacitor on BYP pin will significantly reduce output noise but it may be left unconnected if the output noise is not a major concern. The SPX5205 start-up speed is inversely pro-

portional to the size of the BYP capacitor. Applications requiring a slow ramp-up of the output voltage should use a larger  $C_{BYP}$ . However, if a rapid turn-on is necessary, the BYP capacitor can be omitted.

The SPX5205's internal reference is available through the BYP pin.

The Typical Application Circuit shown on page 1 represents a SPX5205 standard application circuit. The EN (enable) pin is pulled high (>2.0V) to enable the regulator. To disable the regulator,  $EN < 0.4V$ .

The SPX5205 in Figure 1 illustrates a typical adjustable output voltage configuration. Two resistors (R1 and R2) set the output voltage. The output voltage is calculated using the formula:

$$V_{OUT} = 1.235V \times (1 + R1/R2)$$

R2 must be > 10 k $\Omega$  and for best results, R2 should be between 22 k $\Omega$  and 47k $\Omega$ . A capacitor placed between adjustable and ground will provide improved noise performance.

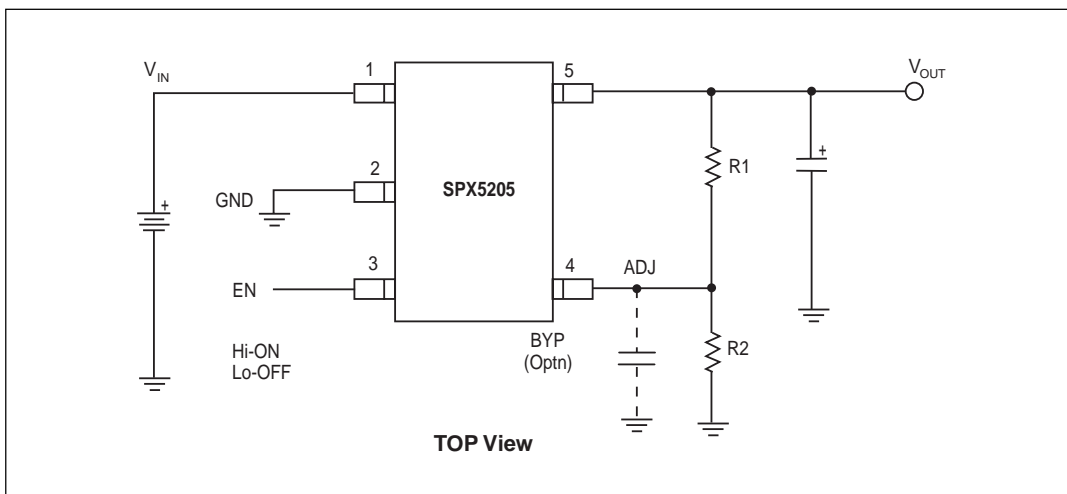
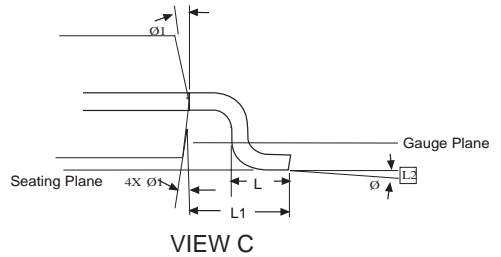
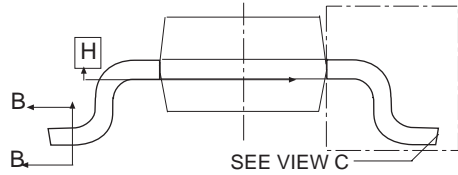
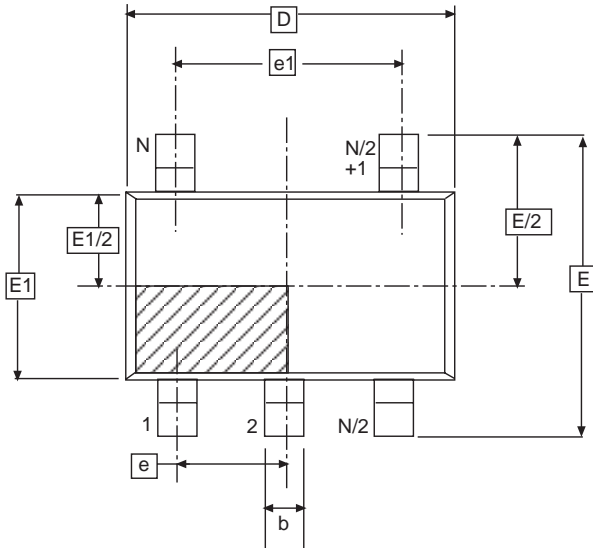
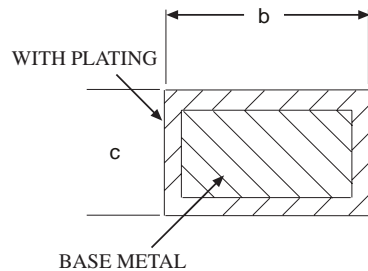
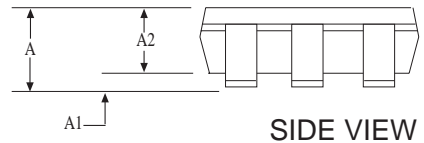

Figure 1. Typical Adjustable Output Voltage.



Dimensions in (mm)	5 PIN SOT-23 JEDEC MO-178 (AA) Variation		
	MIN	NOM	MAX
A	-	-	1.45
A1	0	-	0.15
A2	0.90	1.15	1.30
b	0.30	-	0.50
c	0.08	-	0.22
D	2.90 BSC		
e	0.95 BSC		
e1	1.90 BSC		
E	2.80 BSC		
E1	1.60 BSC		
L	0.30	0.45	0.60
L1	0.60 REF		
L2	0.25 BSC		
Ø	0°	4°	8°
Ø1	5°	10°	15°



## 5 PIN SOT-23

---

**ORDERING INFORMATION**

<b>PART NUMBER</b>	<b>TOP MARK</b>	<b>ACC.</b>	<b>OUTPUT VOLTAGE</b>	<b>PACKAGE</b>
SPX5205M5 .....	H1WW .....	1% .....	Adj .....	5 Pin SOT-23
SPX5205M5-1.2 .....	R12 .....	1% .....	1.2V .....	5 Pin SOT-23
SPX5205M5-1.5 .....	R15 .....	1% .....	1.5V .....	5 Pin SOT-23
SPX5205M5-1.8 .....	R18 .....	1% .....	1.8V .....	5 Pin SOT-23
SPX5205M5-2.0 .....	R20 .....	1% .....	2.0V .....	5 Pin SOT-23
SPX5205M5-2.5 .....	R25 .....	1% .....	2.5V .....	5 Pin SOT-23
SPX5205M5-2.8 .....	R28 .....	1% .....	2.8V .....	5 Pin SOT-23
SPX5205M5-3.0 .....	R30 .....	1% .....	3.0V .....	5 PIN SOT-23
SPX5205M5-3.3 .....	R33 .....	1% .....	3.3V .....	5 Pin SOT-23
SPX5205M5-5.0 .....	R50 .....	1% .....	5.0V .....	5 Pin SOT-23



ANALOG EXCELLENCE

**Sipex Corporation**

**Headquarters and  
Sales Office**

233 South Hillview Drive  
Milpitas, CA 95035  
TEL: (408) 934-7500  
FAX: (408) 935-7600

**Sales Office**

22 Linnell Circle  
Billerica, MA 01821  
TEL: (978) 667-8700  
FAX: (978) 670-9001  
e-mail: sales@sipex.com

Sipex Corporation reserves the right to make changes to any products described herein. Sipex does not assume any liability arising out of the application or use of any product or circuit described herein; neither does it convey any license under its patent rights nor the rights of others.