



**150 mA, Low-Noise LDO Voltage Regulator
(Preliminary Information)**

FEATURES

- Low Noise Output LDO
- 1% Initial Accuracy At 150mA
- Very Low Quiescent Current
- Low Dropout Voltage (210mV At 150mA)
- Current & Thermal Limiting
- Reverse-Battery Protection
- Wide Range of Fix Output Voltages
1.8V, 2.5V, 2.8V, 3.0V, 3.3V, 4.0V, 4.5V, & 5.0V
- Zero Off-Mode Current
- Small 5-Pin SOT-23
- Pin Compatible to MIC5205/MAX8877 (Fixed Option Only)

APPLICATIONS

- PDA
- Battery Powered Systems
- Cellular Phone
- Cordless Telephones
- Radio Control Systems
- Portable/Palm Top/Notebook Computers
- Portable Consumer Equipment
- Portable Instrumentation
- Bar Code Scanners
- SMPS Post-Regulator

PRODUCT DESCRIPTION

The SPX5205 is an excellent choice for use in battery-powered applications, and where power conservation is desired. Such as: cellular/ cordless telephones, radio control systems, and portable computers.

This device is a positive voltage regulator with very low dropout voltage and low output noise. It uses very little quiescent current of 750 μ A at 100 mA output load. V_{OUT} tolerance is less than 1% with a compensated temperature coefficient. Many fixed output voltages, as listed below, or an adjustable version are available in a small 5-pin SOT-23 package.

Other key features include: Zero off-mode current, protection against reversed battery, thermal and current limiting.

MARKING INFORMATION

Voltage	Marking	Voltage	Marking
1.8	R1XX	4.0	R7XX
2.5	R2XX	4.5	R8XX
2.8	R3XX		
3.0	R5XX	5.0	RBXX
3.3	R6XX	ADJ	RCXX

PIN CONNECTIONS

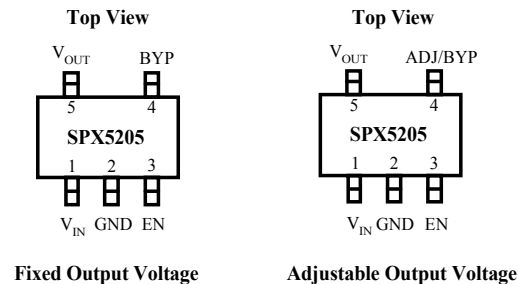

ABSOLUTE MAXIMUM RATINGS

Thermal Shutdown	Internally Limited
Lead Temp. (Soldering, 5 Seconds)	260°C
Operating Junction Temperature Range	-40°C to +125°C
Input Supply Voltage	-20V to +20V
Enable Input Voltage	-20V to +20V

RECOMMENDED OPERATING CONDITIONS

Input Voltage	+2.5V to +16V
Operating Junction Temperature Range	-40°C to +125°C
Enable Input Voltage	0V to V_{IN}
SOT-23-5 (θ_{JA})	See Note 1

ELECTRICAL CHARACTERISTICS

$T_J = 25^\circ\text{C}$, $V_{IN} = V_{OUT} + 1\text{V}$, $I_L = 100\mu\text{A}$, $C_L = 1\mu\text{F}$, and $V_{ENABLE} \geq 2.4\text{V}$. Unless otherwise specified **boldface** applies over the junction temperature range

Parameter	Test Conditions	Typ	Min	Max	Units
Output Voltage Tolerance (V_{OUT})	$I_L = 100\mu\text{A}$ $I_L = 500\mu\text{A}$		-1 -2	+1 +2	% V_{NOM}
Output Voltage Temperature Coefficient		57			ppm/ $^\circ\text{C}$
Line Regulation	$V_{IN} = V_{OUT} + 1\text{V}$ to 16V $V_{IN} = V_{OUT} + 1\text{V}$ to 16V	0.03		0.1 0.2	%/V
Load Regulation	$I_L = 0.1\text{mA}$ to 150mA $I_L = 0.1\text{mA}$ to 150mA	0.1		0.2 0.5	%
Dropout Voltage (See Note 2) ($V_{IN} - V_O$)	$I_L = 100\mu\text{A}$	30		50 70	mV
	$I_L = 50\text{mA}$	140		190 230	
	$I_L = 100\text{mA}$	180		250 300	
	$I_L = 150\text{mA}$	210		275 350	
Quiescent Current (I_{GND})	$V_{ENABLE} \leq 0.6\text{V}$	< 1		1	μA
	$V_{ENABLE} \leq 0.25\text{V}$			5	
Ground Pin Current (I_{GND})	$I_L = 100\mu\text{A}$	80		125 150	μA
	$I_L = 50\text{mA}$	350		600 800	
	$I_L = 100\text{mA}$	750		1000 1500	
	$I_L = 150\text{mA}$	1300		1900 2500	
Ripple Rejection (PSRR)		55			dB
Current Limit (I_{LIMIT})	$V_{OUT} = 0\text{V}$	360		500	mA
Output Noise (e_{NO})	$I_L = 50\text{mA}$, $C_L = 1\mu\text{F}$ 10Hz – 100KHz.)	390			μV_{RMS}
Input Voltage Level Logic Low (V_{IL})	OFF			0.6	V
Input Voltage Level Logic High (V_{IH})	ON		2.0		
ENABLE Input Current	$V_{IL} \leq 0.6\text{V}$	0.01		2	μA
	$V_{IH} \geq 2.0\text{V}$	2		20	

Note 1: The maximum allowable power dissipation is a function of maximum operating junction temperature, $T_{J(max)}$, the junction to ambient thermal resistance, and the ambient, θ_{JA} , and the ambient temperature T_A . The maximum allowable power dissipation at any ambient temperature is given:

$P_{D(max)} = (T_{J(max)} - T_A)/\theta_{JA}$, exceeding the maximum allowable power limit will result in excessive die temperature; thus, the regulator will go into thermal shutdown.

The θ_{JA} of the SPX5205 is 220°C/W mounted on a PC board.

Note 2: Not apply to 1.8V version.

TYPICAL APPLICATION

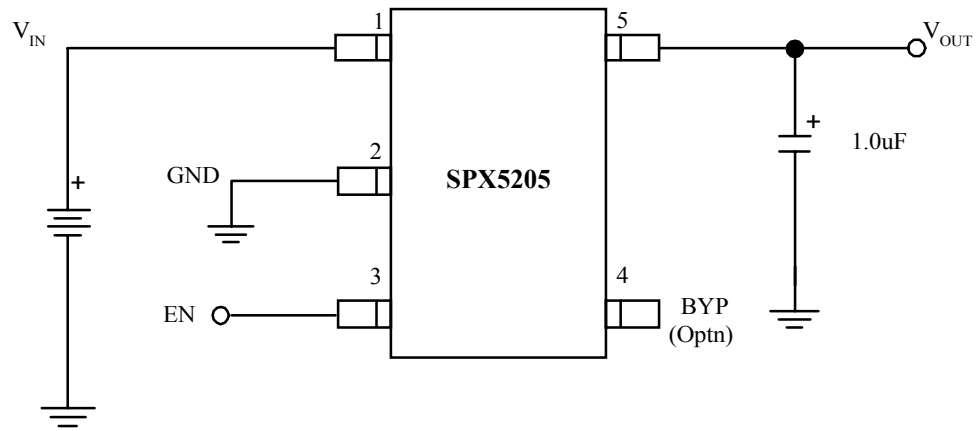

ENABLE may be tied directly to V_{IN}

Application Hints

The SPX5205 requires an output capacitor for device stability. The value required varies greatly depending upon the application circuit. The high frequency characteristics of electrolytic capacitors depend greatly on the type and also on the manufacturer. Sometimes bench testing is the only means to determine the proper capacitor type and value. The high quality 2.2μF aluminum electrolytic capacitor covers all general application circuits; this stability can be obtained with a tantalum electrolytic value of 1μF.

In general, linear regulator stability decreases with higher output currents. In most applications the SPX5205 is operating at few milliamps. In these applications the output capacitance can be further reduced. For example, when the regulator is running at 10mA output current the output capacitance value is half compared to the same regulator that is running at 150mA.

With the SPX5205 adjustable regulator, the minimum value of output capacitance is a function of the output voltage. The value decreases with higher output voltages, since the closed loop gain is increased.

Typical Applications Circuits

The SPX5205 provides access to the internal reference. A 10μF capacitor on the BYP pin will provide a significant reduction in output noise. This pin may be left unconnected if the output noise is not a major concern. The SPX5205 start-up speed is inversely proportional to the size of this capacitor. Applications requiring a slow ramp-up of output voltage should consider larger values of C_{BYP}. If the rapid turn-ON is necessary, omit bypass capacitor.

Figure 1 shows SPX5205 standard application circuit. The EN pin is pulled high (>2.0V) to enable the regulator. To disable the regulator, EN < 0.6V.

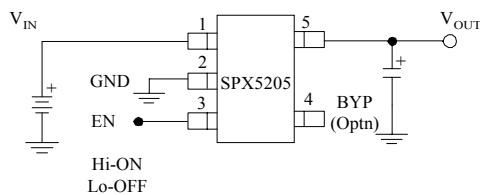

Top View

Fig. 1

The SPX5205 in figure 2 shows adjustable output voltage configuration. Two resistors set the output voltage. The formula for output voltage is:

$$V_{OUT} = 1.235 \times \left(1 + \frac{R1}{R2} \right)$$

Resistor values are not critical as the ADJ pin has high input impedance, for best results use resistors of 47kΩ or less. A capacitor from ADJ to ground will provide improved noise performance.

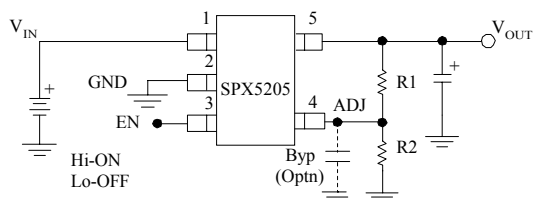

Top View

Fig. 2

PACKAGE DRAWING
SOT-23-5L (M5)

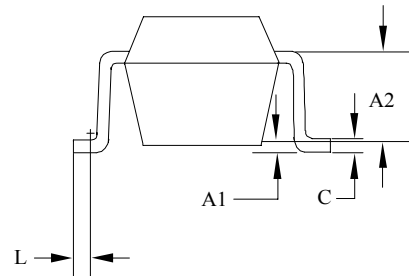
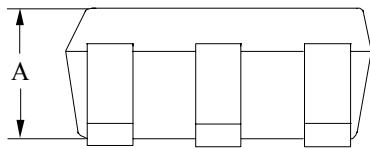
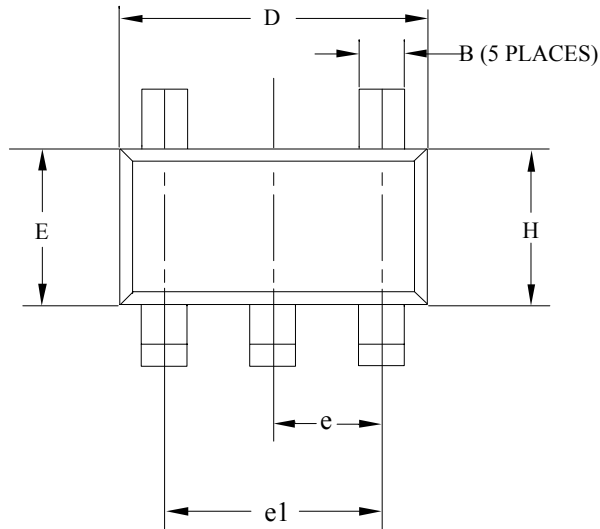

SYMBOL	MILLIMETERS		INCHES	
	MIN.	MAX.	MIN.	MAX.
A	0.90	1.30	.035	.051
A1	0	0.10	0	.004
A2	0.80 REF		.0315 REF	
B	0.30	0.50	.012	.019
C	0.10	0.35	.004	.0137
D	2.70	3.10	.106	.122
E	1.40	1.80	.055	.071
e	0.95 BSC.		.037 BSC.	
e1	1.70	2.10	.066	.082
H	2.50	3.00	.098	.118
L	MIN 0.2		MIN .0078	

- NOTE:
1. REFER TO APPLICABLE
 2. CONTROLLING DIMENTION : MILLIMETER
 3. PACKAGE SURFACE FINISHING TO BE SMOOTH FINISH.

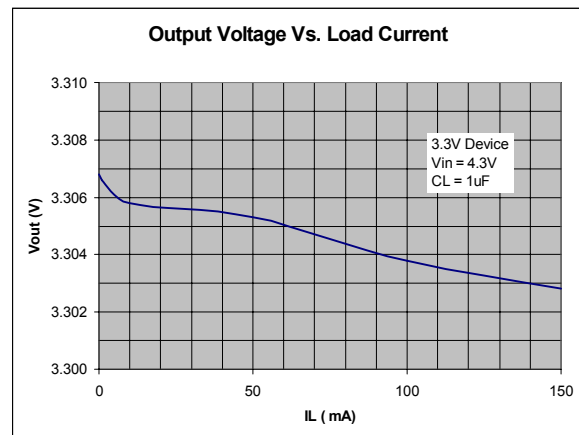
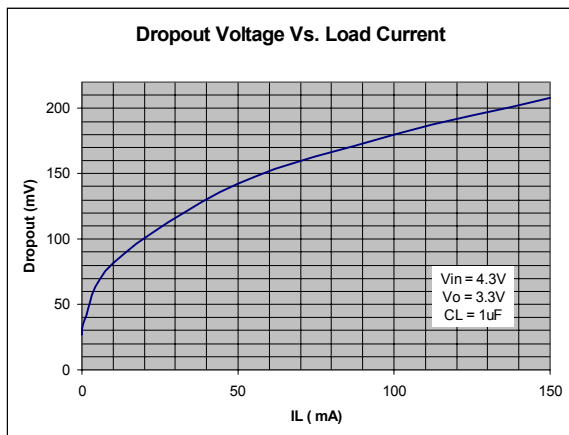
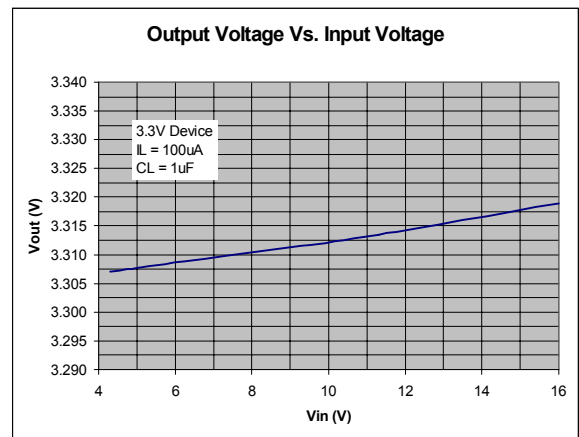
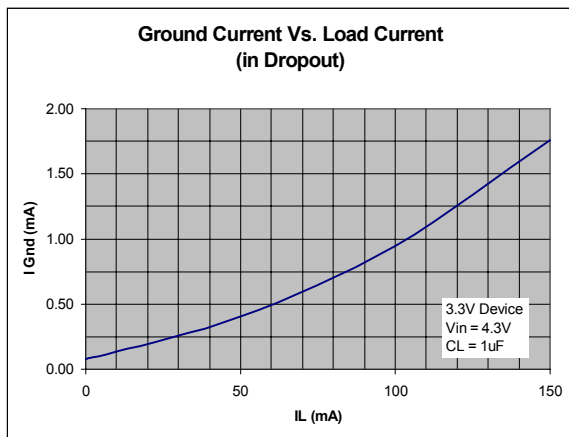
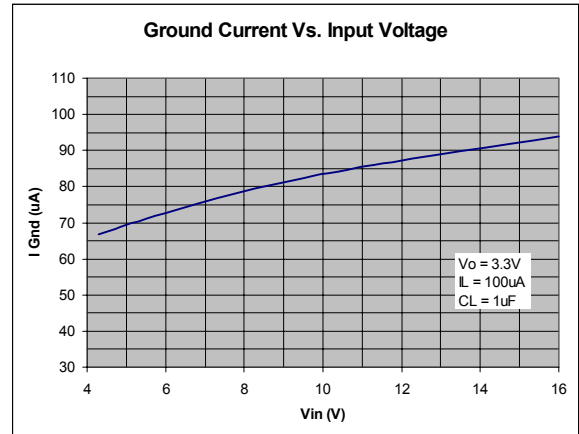
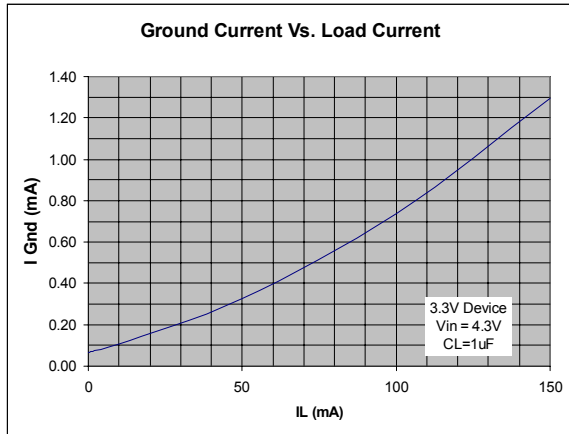

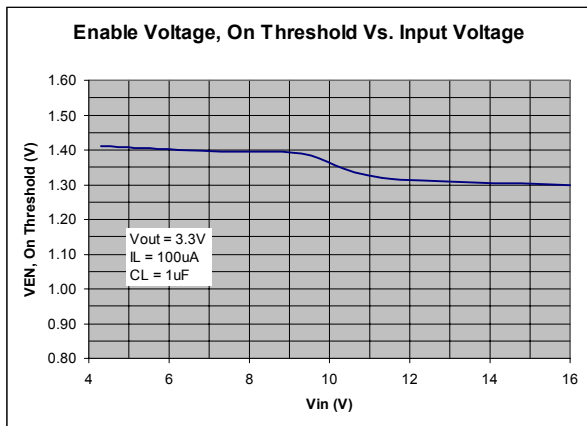
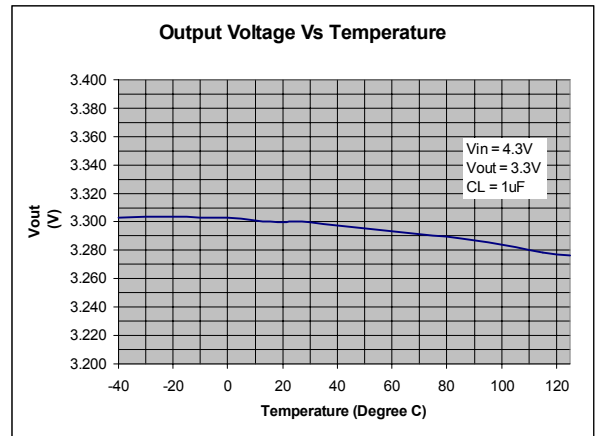
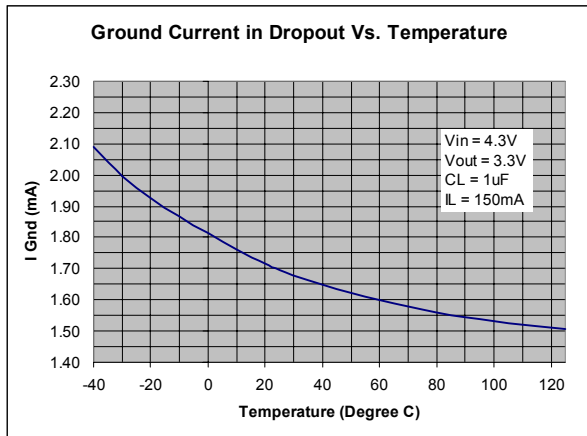
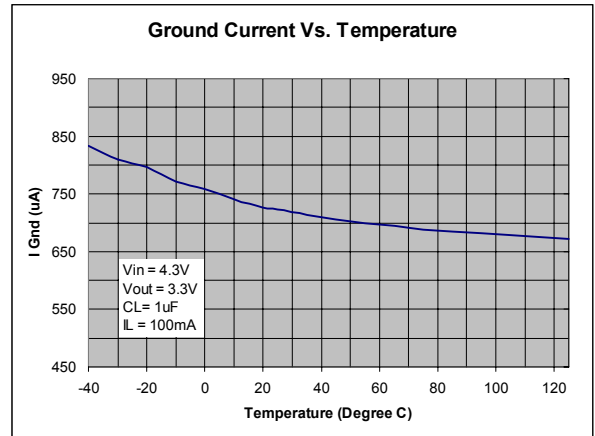
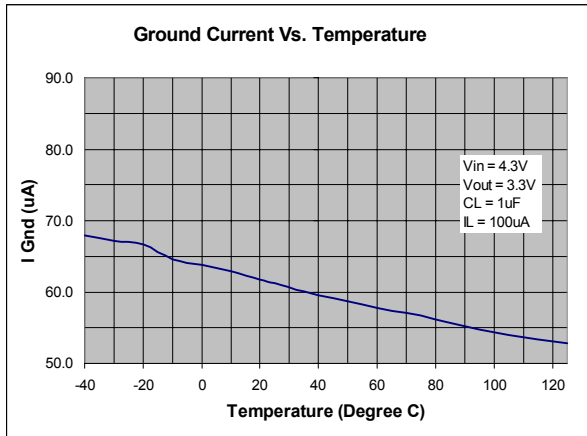

Line Transient Response

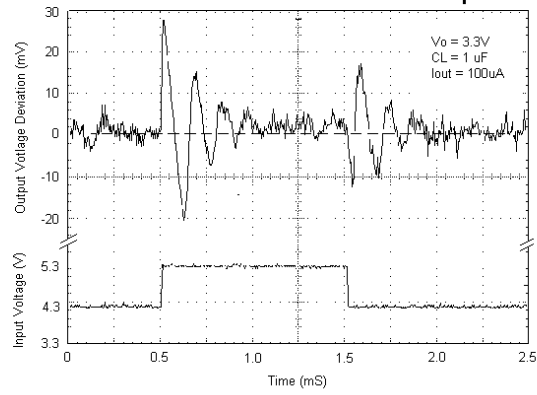

Load Transient Response

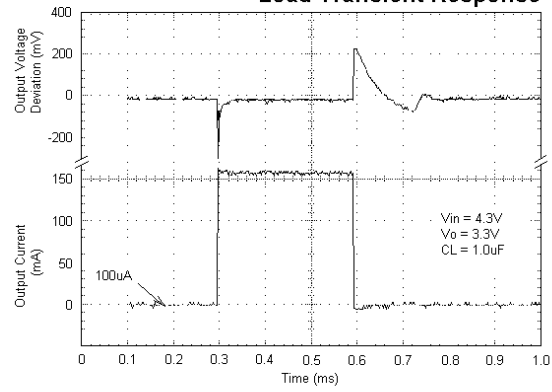

Switching Characteristics

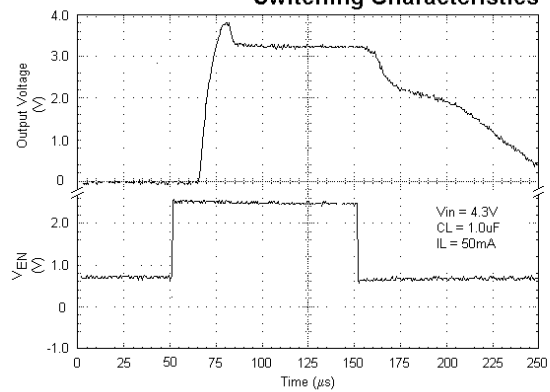

ORDERING INFORMATION

Ordering No.	Output Voltage	Packages
SPX5205M5	Adj	5 Lead SOT-23
SPX5205M5-1.8	1.5V	5 Lead SOT-23
SPX5205M5-2.5	2.5V	5 Lead SOT-23
SPX5205M5-2.8	2.8V	5 Lead SOT-23
SPX5205M5-3.0	3.0V	5 Lead SOT-23
SPX5205M5-3.3	3.3V	5 Lead SOT-23
SPX5205M5-4.0	4.0V	5 Lead SOT-23
SPX5205M5-4.5	4.5V	5 Lead SOT-23
SPX5205M5-5.0	5.0V	5 Lead SOT-23



SIGNAL PROCESSING EXCELLENCE

Sipex Corporation

Headquarters and Main Offices:

22 Linnell Circle
Billerica, MA 01821
TEL: (978) 667-8700
FAX: (978) 670-9001
e-mail: sales@sipex.com

233 South Hillview Drive
Milpitas, CA 95035
TEL: (408) 935-7600
FAX: (408) 934-7500

Sipex Corporation reserves the right to make changes to any products described herein. Sipex does not assume any liability arising out of the application or use of any product or circuit described hereing; neither does it convey any license under its patent rights nor the rights of others.