

COMPLEMENTARY SILICON PLASTIC POWER TRANSISTORS

... designed for use in power amplifier and switching circuit applications

FEATURES:

* Collector-Emitter Sustaining Voltage-

$$V_{CEO(sus)} = 45 \text{ V (Min) - 2N6121, 2N6124}$$

$$= 60 \text{ V (Min) - 2N6122, 2N6125}$$

$$= 80 \text{ V (Min) - 2N6123, 2N6126}$$

* Collector-Emitter Saturation Voltage

$$V_{CE(sat)} = 0.6 \text{ V (Max.) @ } I_C = 1.5 \text{ A, } I_B = 0.15 \text{ A}$$

NPN	PNP
2N6121	2N6124
2N6122	2N6125
2N6123	2N6126

**4 AMPERE
COMPLEMENTARY SILICON
POWER TRANSISTORS**
45-80 Volts
40 Watts

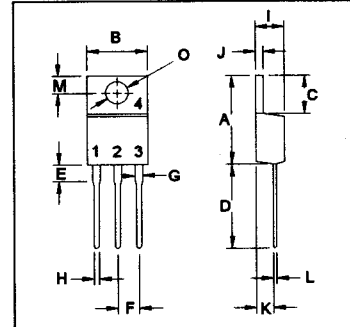
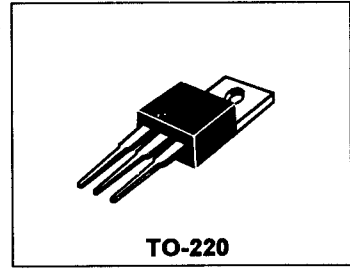

PIN 1.BASE
2.COLLECTOR
3.EMITTER
4.COLLECTO(CASE)

DIM	MILLIMETERS	
	MIN	MAX
A	14.68	15.31
B	9.78	10.42
C	5.01	6.52
D	13.06	14.62
E	3.57	4.07
F	2.42	3.66
G	1.12	1.36
H	0.72	0.96
I	4.22	4.98
J	1.14	1.38
K	2.20	2.97
L	0.33	0.55
M	2.48	2.98
O	3.70	3.90

MAXIMUM RATINGS

Characteristic	Symbol	2N6121 2N6124	2N6122 2N6125	2N6123 2N6126	Unit
Collector-Emitter Voltage	V_{CEO}	45	60	80	V
Collector-Base Voltage	V_{CBO}	45	60	80	V
Emitter-Base Voltage	V_{EBO}	5.0			V
Collector Current - Continuous - Peak	I_C	4.0 8.0			A
Base Current	I_B	1.0			A
Total Power Dissipation@ $T_C = 25^\circ\text{C}$ Derate above 25°C	P_D	40 0.32			W W/ $^\circ\text{C}$
Operating and Storage Junction Temperature Range	T_J, T_{STG}	-65 to +150			$^\circ\text{C}$

THERMAL CHARACTERISTICS

Characteristic	Symbol	Max	Unit
Thermal Resistance Junction to Case	$R_{\theta jc}$	3.125	$^\circ\text{C/W}$

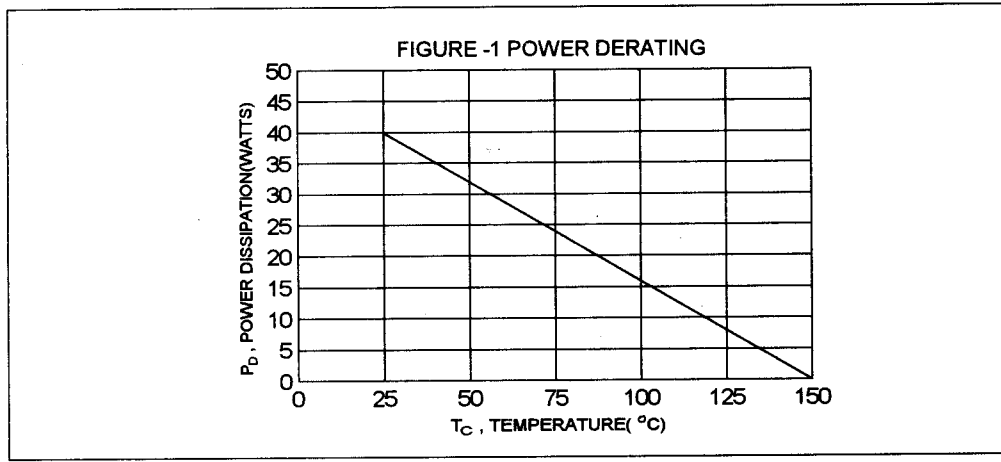

2N6121, 2N6122, 2N 6123 NPN / 2N6124, 2N6125, 2N6126 PNP

ELECTRICAL CHARACTERISTICS ($T_c = 25^\circ\text{C}$ unless otherwise noted)

Characteristic	Symbol	Min	Max	Unit
----------------	--------	-----	-----	------

OFF CHARACTERISTICS

Collector - Emitter Sustaining Voltage (1) ($I_C = 100 \text{ mA}$, $I_B = 0$) 2N6121, 2N6124 2N6122, 2N6125 2N6123, 2N6126	$V_{CEO(sus)}$	45 60 80		V
Collector Cutoff Current ($V_{CE} = 45 \text{ V}$, $I_B = 0$) ($V_{CE} = 60 \text{ V}$, $I_B = 0$) ($V_{CE} = 80 \text{ V}$, $I_B = 0$) 2N6121, 2N6124 2N6122, 2N6125 2N6123, 2N6126	I_{CEO}		1.0 1.0 1.0	mA
Collector Cutoff Current ($V_{CE} = 45 \text{ V}$, $V_{BE(off)} = 1.5 \text{ V}$) ($V_{CE} = 60 \text{ V}$, $V_{BE(off)} = 1.5 \text{ V}$) ($V_{CE} = 80 \text{ V}$, $V_{BE(off)} = 1.5 \text{ V}$) ($V_{CE} = 45 \text{ V}$, $V_{BE(off)} = 1.5 \text{ V}$, $T_c = 125^\circ\text{C}$) ($V_{CE} = 60 \text{ V}$, $V_{BE(off)} = 1.5 \text{ V}$, $T_c = 125^\circ\text{C}$) ($V_{CE} = 80 \text{ V}$, $V_{BE(off)} = 1.5 \text{ V}$, $T_c = 125^\circ\text{C}$) 2N6121, 2N6124 2N6122, 2N6125 2N6123, 2N6126 2N6121, 2N6124 2N6122, 2N6125 2N6123, 2N6126	I_{CEX}		0.1 0.1 0.1 2.0 2.0 2.0	mA
Emitter Cutoff Current ($V_{EB} = 5.0 \text{ V}$, $I_C = 0$)	I_{EBO}		1.0	mA

ON CHARACTERISTICS (1)

DC Current Gain ($I_C = 1.5 \text{ A}$, $V_{CE} = 2.0 \text{ V}$) 2N6121, 2N6124 2N6122, 2N6125 2N6123, 2N6126 ($I_C = 4.0 \text{ A}$, $V_{CE} = 2.0 \text{ V}$) 2N6121, 2N6124 2N6122, 2N6125 2N6123, 2N6126	hFE	25 25 20 10 10 7.0	100 100 80	
Collector-Emitter Saturation Voltage ($I_C = 1.5 \text{ A}$, $I_B = 0.15 \text{ A}$) ($I_C = 4.0 \text{ A}$, $I_B = 1.0 \text{ A}$)	$V_{CE(sat)}$		0.6 1.4	V
Base-Emitter On Voltage ($I_C = 1.5 \text{ A}$, $V_{CE} = 2.0 \text{ V}$)	$V_{BE(on)}$		1.2	V

DYNAMIC CHARACTERISTICS

Current-Gain-Bandwidth Product (2) ($I_C = 1.0 \text{ A}$, $V_{CE} = 4.0 \text{ V}$, $f_r = 1.0 \text{ MHz}$)	f_T	2.5		MHz
Small-Signal Current Gain ($I_C = 0.1 \text{ A}$, $V_{CE} = 2.0 \text{ V}$, $f = 1.0 \text{ KHZ}$)	h_{fe}	25		

(1) Pulse Test: Pulse width = 300 us , Duty Cycle $\leq 2.0\%$

(2) $f_T = |h_{fe}| \cdot f_{test}$

ACTIVE-REGION SAFE OPERATING AREA (SOA)

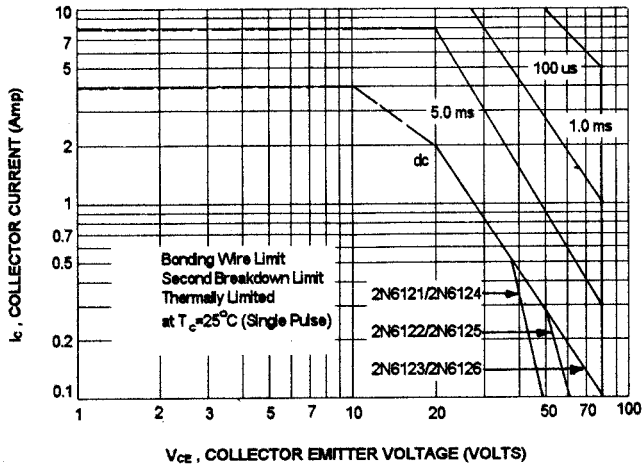

There are two limitation on the power handling ability of a transistor: average junction temperature and second breakdown safe operating area curves indicate I_C - V_{CE} limits of the transistor that must be observed for reliable operation i.e., the transistor must not be subjected to greater dissipation than curves indicate.

The data of SOA curve is base on $T_{J(PK)} = 150^\circ\text{C}$; T_c is variable depending on conditions. second breakdown pulse limits are valid for duty cycles to 10% provided $T_{J(PK)} \leq 150^\circ\text{C}$. At high case temperatures, thermal limitation will reduce the power that can be handled to values less than the limitations imposed by second breakdown.

CAPACITANCES

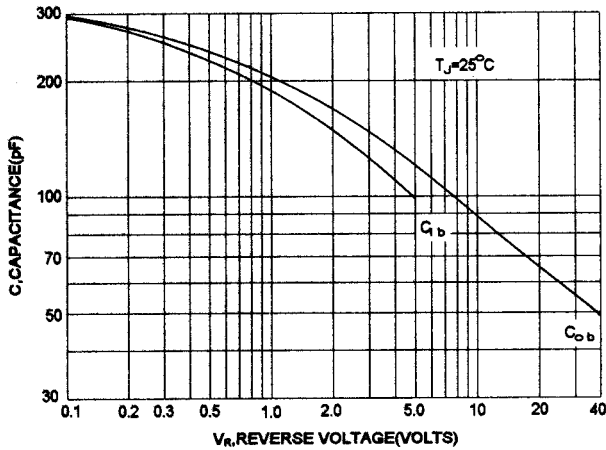

COLLECTOR CUT-OFF REGION

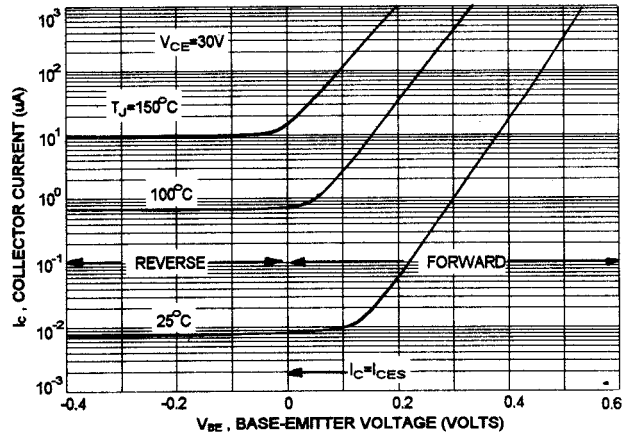

TURN-ON TIME

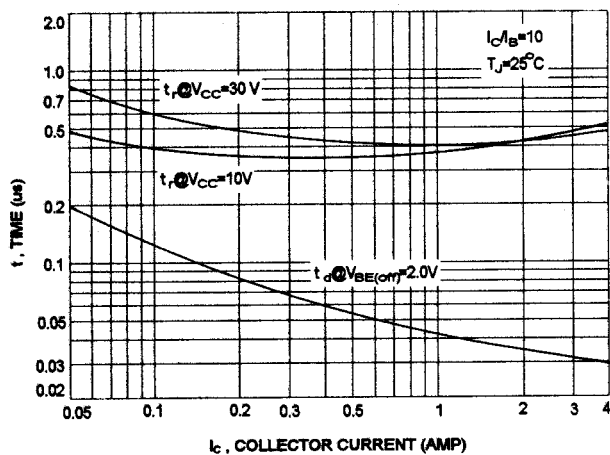

TURN-OFF TIME

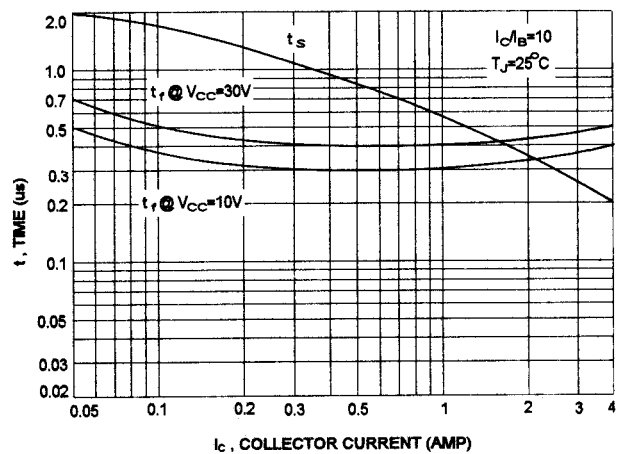

2N6121,2N6122,2N6123, NPN / 2N6124,2N6125,2N6126 PNP

DC CURRENT GAIN

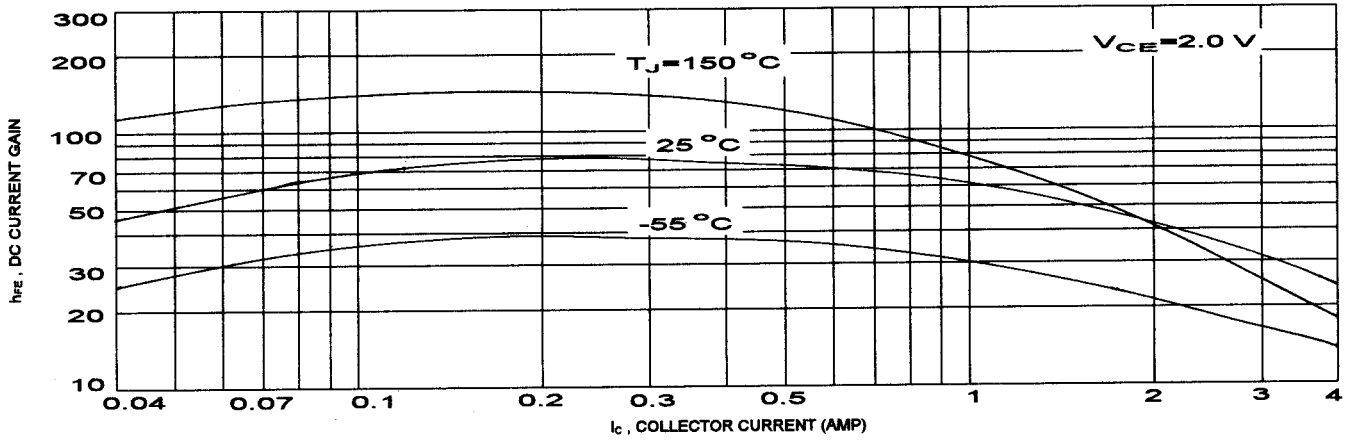

COLLECTOR SATURATION REGION

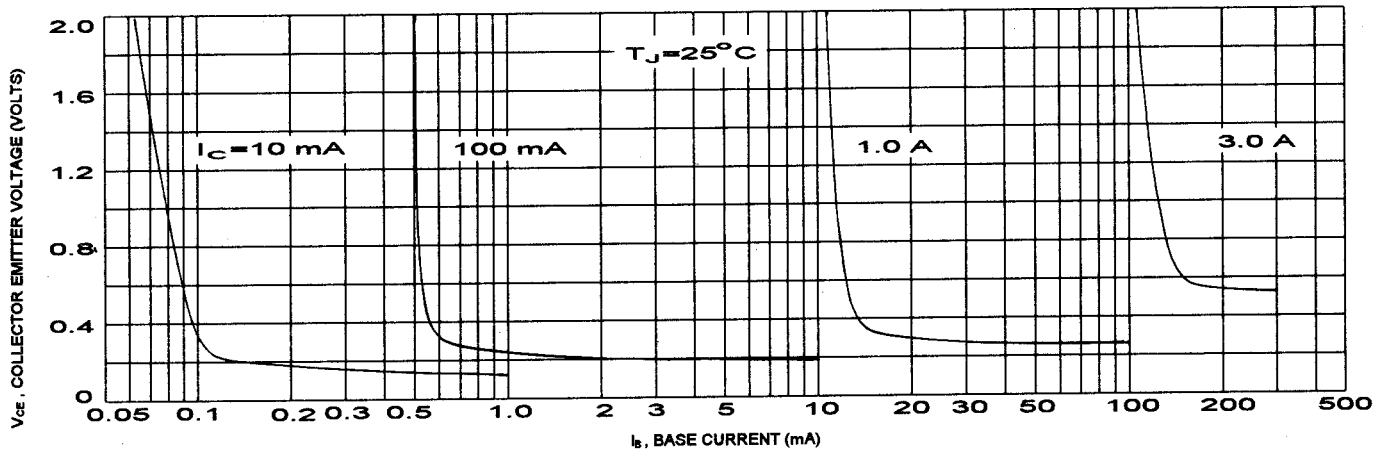

"ON" VOLTAGES

