

## SWITCHMODE SERIES NPN POWER TRANSISTORS

... designed for use in high-voltage, high-speed, power switching in inductive circuit, they are particularly suited for 115 and 220 V switchmode applications such as switching regulator's, inverters, DC -DC conveter, Motor Controls, Solenoid drive and Deflection circuits.

### FEATURES:

\*Collector-Emitter Sustaining Voltage-

$$V_{CE(sus)} = 400 \text{ V and } 300 \text{ V}$$

\* Collector-Emitter Saturation Voltage -

$$V_{CE(sat)} = 3.0 \text{ V (Max.) @ } I_C = 8.0 \text{ A, } I_B = 2.0 \text{ A}$$

\* Switching Time -  $t_f = 0.7 \text{ us (Max.) @ } I_C = 5.0 \text{ A}$

\* SOA and Switching Application Information.

**NPN**  
**MJE13006**  
**MJE13007**

**8 AMPERE**  
**POWER**  
**TRANSISTORS**  
**300-400 VOLTS**  
**80 WATTS**

### MAXIMUM RATINGS

Characteristic	Symbol	MJE13006	MJE13007	Unit
Collector-Emitter Voltage	$V_{CEO}$	300	400	V
Collector-Emitter Voltage	$V_{CEV}$	600	700	V
Emitter-Base Voltage	$V_{EBO}$	9		V
Collector Current - Continuous	$I_C$	8		A
Collector Current - Peak	$I_{CM}$	16		A
Base current	$I_B$	4		A
Total Power Dissipation @ $T_C = 25^\circ\text{C}$ Derate above $25^\circ\text{C}$	$P_D$	80	640	W mW/°C
Operating and Storage Junction Temperature Range	$T_J, T_{STG}$	-65 to +150		°C

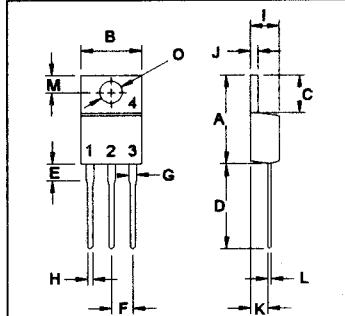
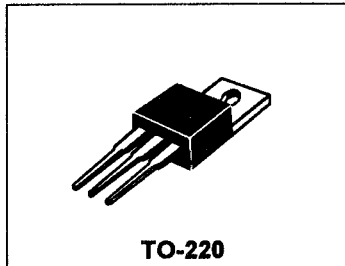

PIN 1.BASE  
2.COLLECTOR  
3.EMITTER  
4.COLLECTOR(CASE)

### THERMAL CHARACTERISTICS

Characteristic	Symbol	Max	Unit
Thermal Resistance Junction to Case	$R_{\theta jc}$	1.56	°C/W

DIM	MILLIMETERS	
	MIN	MAX
A	14.68	15.31
B	9.78	10.42
C	5.01	6.52
D	13.06	14.62
E	3.57	4.07
F	2.42	3.66
G	1.12	1.36
H	0.72	0.96
I	4.22	4.98
J	1.14	1.38
K	2.20	2.97
L	0.33	0.55
M	2.48	2.98
O	3.70	3.90

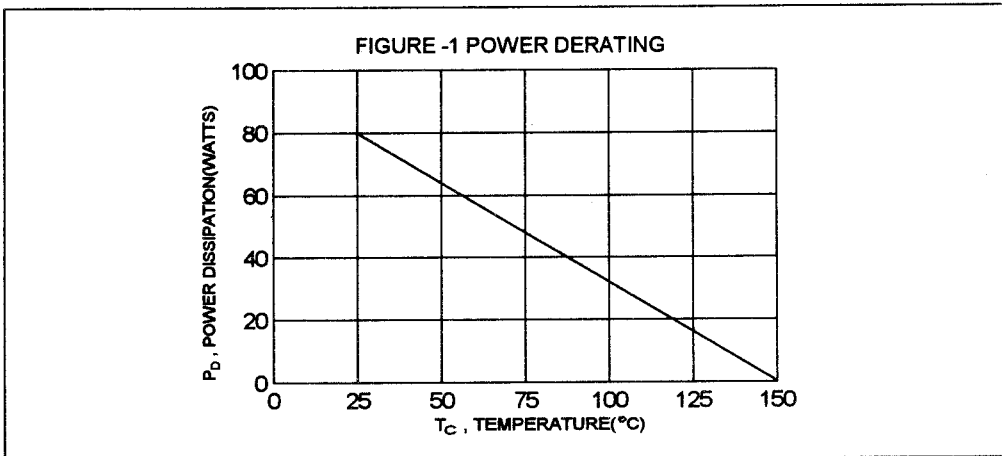

**ELECTRICAL CHARACTERISTICS** (  $T_c = 25^\circ\text{C}$  unless otherwise noted )

Characteristic	Symbol	Min	Max	Unit
----------------	--------	-----	-----	------

**OFF CHARACTERISTICS**

Collector-Emitter Sustaining Voltage ( $I_C = 10\text{ mA}, I_B = 0$ ) MJE13006 MJE13007	$V_{CEO(sus)}$	300 400		V
Collector Cutoff Current ( $V_{CEV} = \text{Rated Value}, V_{BE(off)} = 1.5\text{ V}$ ) ( $V_{CEV} = \text{Rated Value}, V_{BE(off)} = 1.5\text{ V}, T_c = 100^\circ\text{C}$ )	$I_{CEV}$		1.0 5.0	mA
Emitter Cutoff Current ( $V_{EB} = 9.0\text{ V}, I_C = 0$ )	$I_{EBO}$		1.0	mA

**ON CHARACTERISTICS (1)**

DC Current Gain ( $I_C = 2.0\text{ A}, V_{CE} = 5.0\text{ V}$ ) ( $I_C = 5.0\text{ A}, V_{CE} = 5.0\text{ V}$ )	hFE	8.0 5.0	60 30	
Collector-Emitter Saturation Voltage ( $I_C = 2.0\text{ A}, I_B = 400\text{ mA}$ ) ( $I_C = 5.0\text{ A}, I_B = 1.0\text{ A}$ ) ( $I_C = 8.0\text{ A}, I_B = 2.0\text{ A}$ )	$V_{CE(sat)}$		1.0 2.0 3.0	V
Base-Emitter Saturation Voltage ( $I_C = 2.0\text{ A}, I_B = 400\text{ mA}$ ) ( $I_C = 5.0\text{ A}, I_B = 1.0\text{ A}$ )	$V_{BE(sat)}$		1.2 1.6	V

**DYNAMIC CHARACTERISTICS**

Current Gain - Bandwidth Product ( $I_C = 500\text{ mA}, V_{CE} = 10\text{ V}, f = 1.0\text{ MHz}$ )	$f_T$	4.0		MHz
Output Capacitance ( $V_{CB} = 10\text{ V}, I_E = 0, f = 0.1\text{ MHz}$ )	$C_{ob}$	110(typ)		pF

**SWITCHING CHARACTERISTICS**

Delay Time	$V_{CC} = 125\text{ V}, I_C = 5.0\text{ A}$ $I_{B1} = -I_{B2} = 1.0\text{ A}$ $t_p = 25\text{ us}, \text{Duty Cycle} \leq 1.0\%$	$t_d$	0.1	us
Rise Time		$t_r$	1.5	us
Storage Time		$t_s$	3.0	us
Fall Time		$t_f$	0.7	us

(1) Pulse Test: Pulse Width = 300 us, Duty Cycle  $\leq 2.0\%$

DC CURRENT GAIN

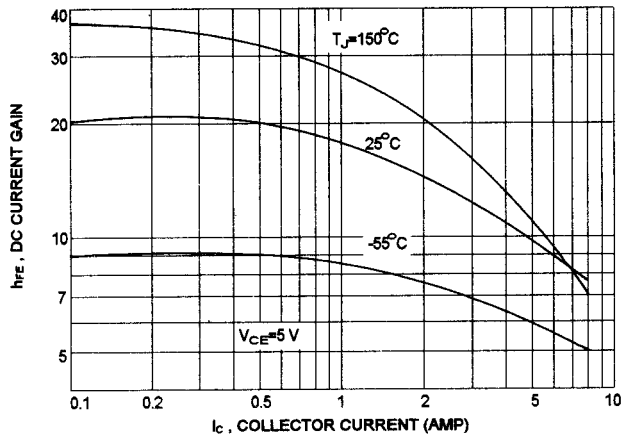

COLLECTOR SATURATION REGION

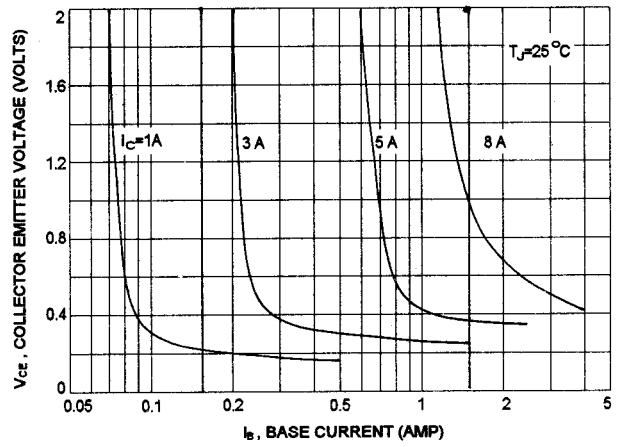

BASE-EMITTER SATURATION VOLTAGE

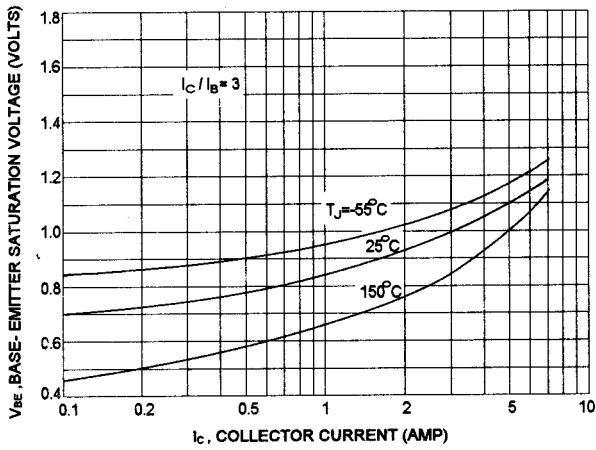

COLLECTOR-EMITTER SATURATION VOLTAGE

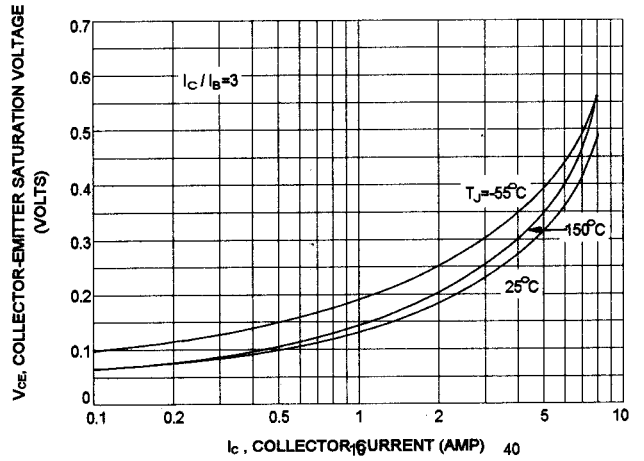

COLLECTOR CUT-OFF REGION

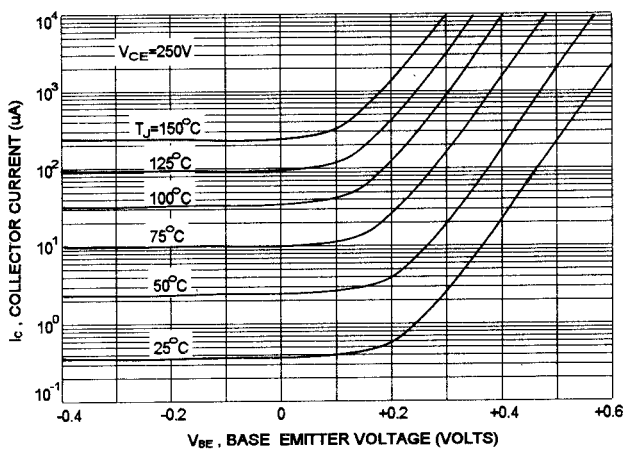

CAPACITANCE

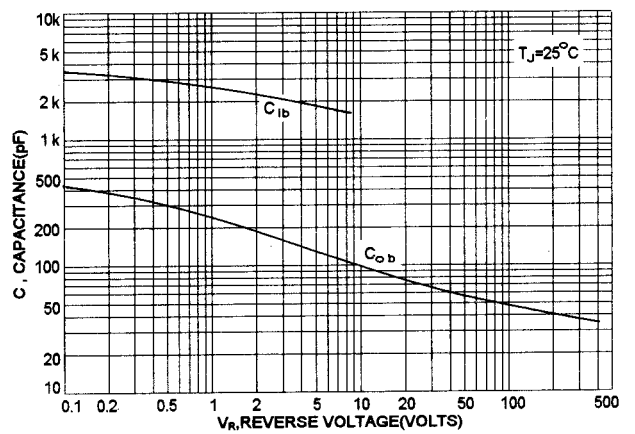

TURN-ON TIME

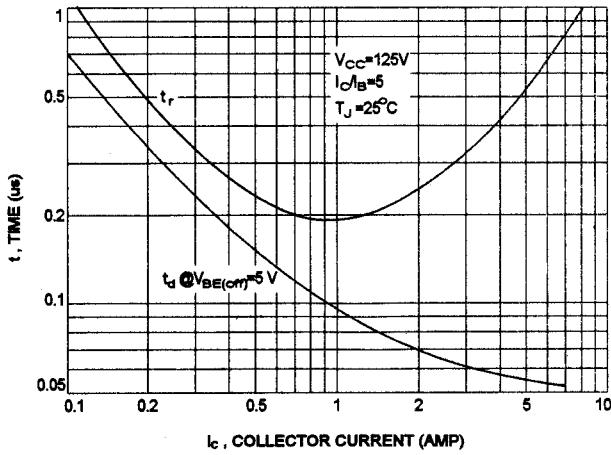

TURN-OFF TIME

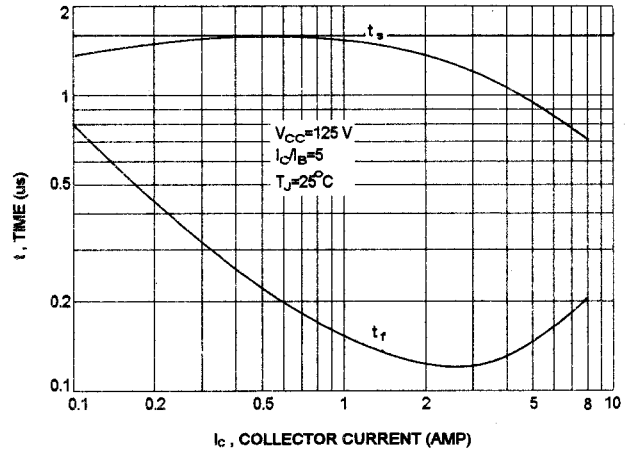

ACTIVE REGION SAFE OPERATING AREA

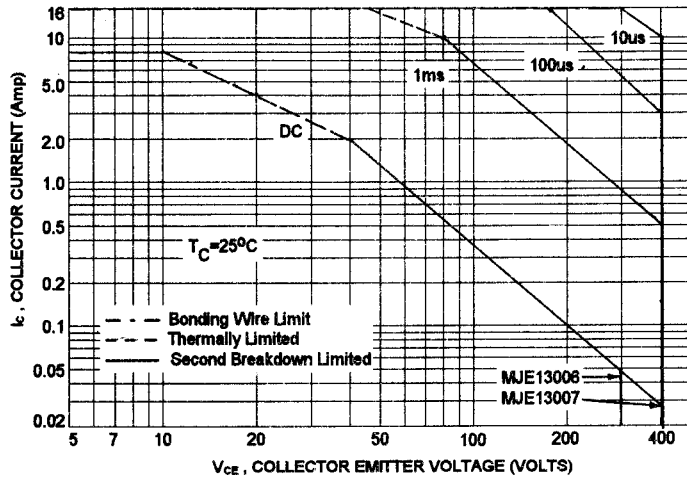

REVERSE BIAS SWITCHING SAFE OPERATING AREA

