

DESCRIPTION The 2SC1842 is designed for use in an AF amplifier and general purpose.

FEATURES

- High h_{FE} . $h_{FE} : 600 \text{ TYP. } (V_{CE} = 6.0 \text{ V, } I_C = 1.0 \text{ mA})$
- Low Noise Voltage. $NV : 30 \text{ mV TYP. } (V_{CE} = 6.0 \text{ V, } I_C = 1.0 \text{ mA, } R_G = 100 \text{ k}\Omega, G_V = 80 \text{ dB, } f = 10 \text{ Hz to } 1.0 \text{ kHz})$

ABSOLUTE MAXIMUM RATINGS

Maximum Temperatures

Storage Temperature $-55 \text{ to } +125 \text{ }^\circ\text{C}$

Junction Temperature $+125 \text{ }^\circ\text{C}$ Maximum

Maximum Power Dissipation ($T_a = 25 \text{ }^\circ\text{C}$)

Total Power Dissipation 250 mW

Maximum Voltages and Currents ($T_a = 25 \text{ }^\circ\text{C}$)

V_{CBO} Collector to Base Voltage 40 V

V_{CEO} Collector to Emitter Voltage 35 V

V_{EBO} Emitter to Base Voltage 5.0 V

I_C Collector Current 100 mA

I_B Base Current 20 mA

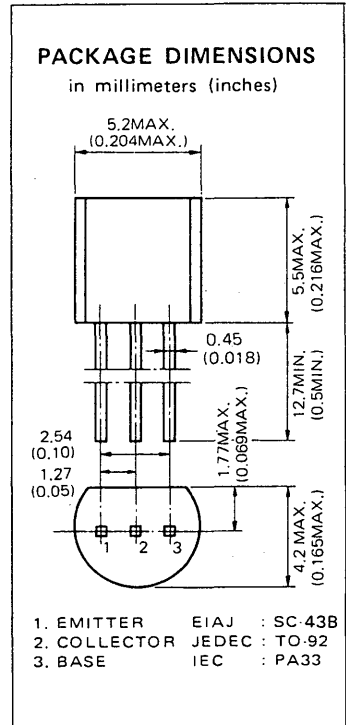

ELECTRICAL CHARACTERISTICS ($T_a = 25 \text{ }^\circ\text{C}$)

SYMBOL	CHARACTERISTIC	MIN.	TYP.	MAX.	UNIT	TEST CONDITIONS
h_{FE1}	DC Current Gain	150	580		—	$V_{CE} = 6.0 \text{ V, } I_C = 0.1 \text{ mA}$
h_{FE2}	DC Current Gain	200	600	1200	—	$V_{CE} = 6.0 \text{ V, } I_C = 1.0 \text{ mA}$
f_T	Gain Bandwidth Product	150	250		MHz	$V_{CE} = 6.0 \text{ V, } I_E = -10 \text{ mA}$
C_{ob}	Output Capacitance		3.0	4.0	pF	$V_{CB} = 6.0 \text{ V, } I_E = 0, f = 1.0 \text{ MHz}$
NV	Noise Voltage		30	50	mV	$V_{CE} = 5.0 \text{ V, } I_C = 1.0 \text{ mA, } R_G = 100 \text{ k}\Omega, G_V = 80 \text{ dB, } f = 10 \text{ Hz to } 1.0 \text{ kHz}$
I_{CBO}	Collector Cutoff Current			100	nA	$V_{CB} = 40 \text{ V, } I_E = 0$
I_{EBO}	Emitter Cutoff Current			100	nA	$V_{EB} = 5.0 \text{ V, } I_C = 0$
$V_{BE(sat)}$	Base Saturation Voltage		0.86	1.0	V	$I_C = 100 \text{ mA, } I_B = 10 \text{ mA}$
$V_{CE(sat)}$	Collector Saturation Voltage		0.15	0.3	V	$I_C = 100 \text{ mA, } I_B = 10 \text{ mA}$
V_{BE}	Base to Emitter Voltage	0.55	0.60	0.65	V	$V_{CE} = 6.0 \text{ V, } I_C = 1.0 \text{ mA}$

Classification of h_{FE2}

Rank	P	F	E	U
Range	200 - 400	300 - 600	400 - 800	600 - 1200

h_{FE} Test Conditions : $V_{CE} = 6.0 \text{ V, } I_C = 1.0 \text{ mA}$

TYPICAL CHARACTERISTICS (Ta = 25 °C unless otherwise noted)

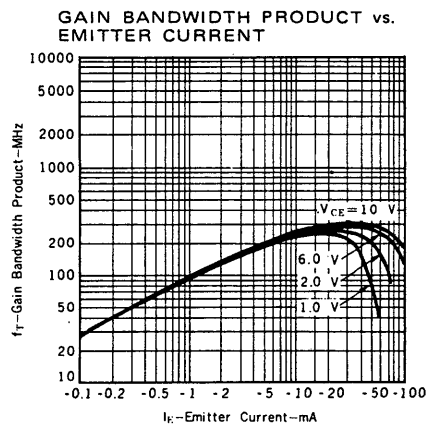
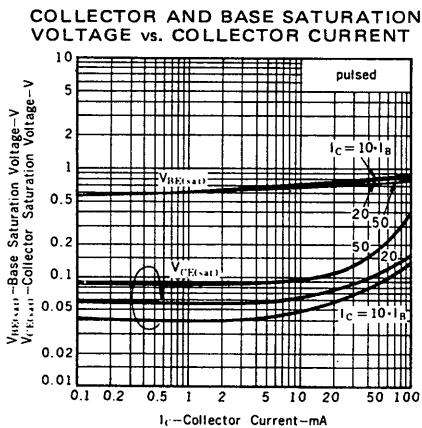
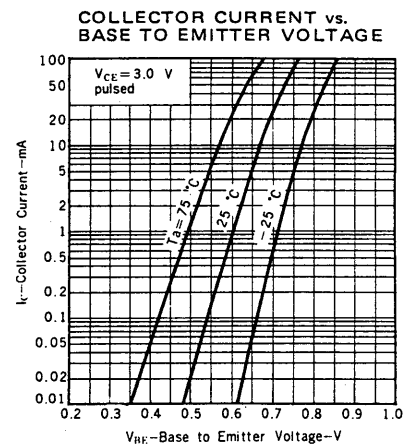
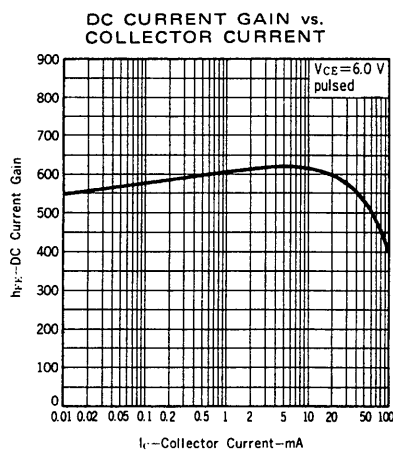
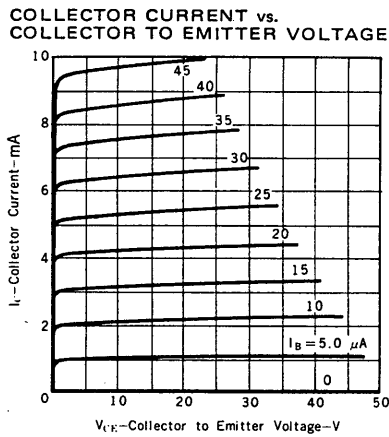
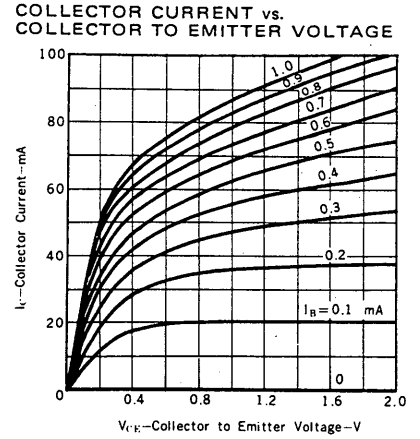
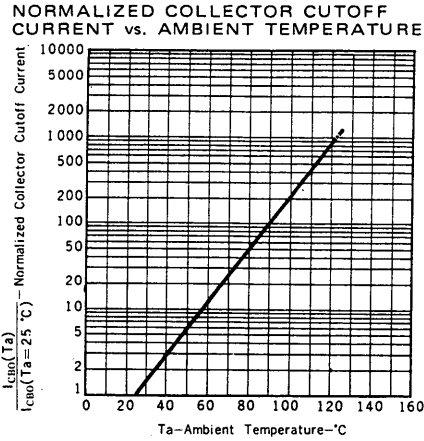
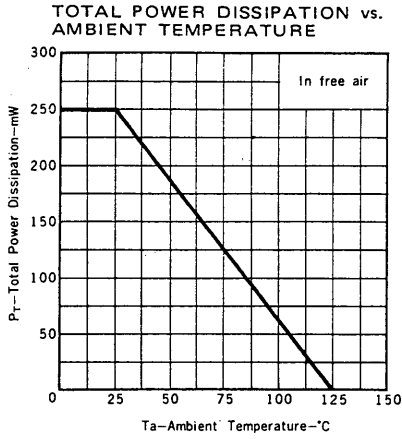

INPUT AND OUTPUT CAPACITANCE vs. REVERSE VOLTAGE

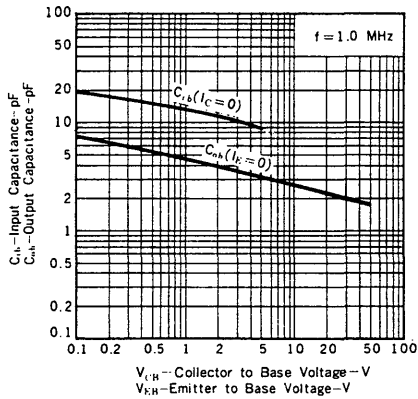

SMALL SIGNAL CURRENT GAIN vs. DC CURRENT GAIN

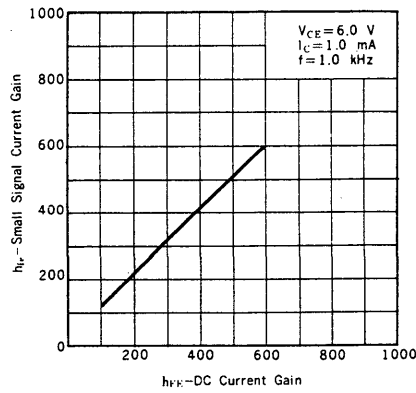

INPUT IMPEDANCE, VOLTAGE FEEDBACK RATIO AND OUTPUT ADMITTANCE vs. SMALL SIGNAL CURRENT GAIN

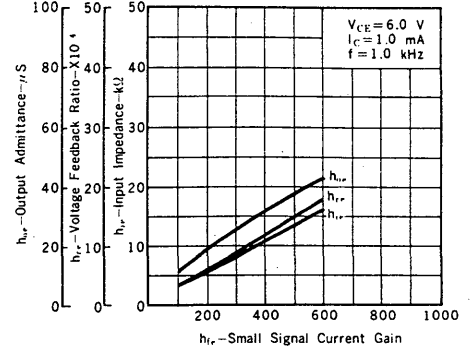

NORMALIZED h-PARAMETERS vs. COLLECTOR CURRENT

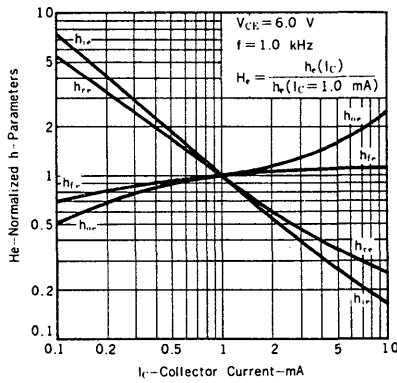

NORMALIZED h-PARAMETERS vs. COLLECTOR TO EMITTER VOLTAGE

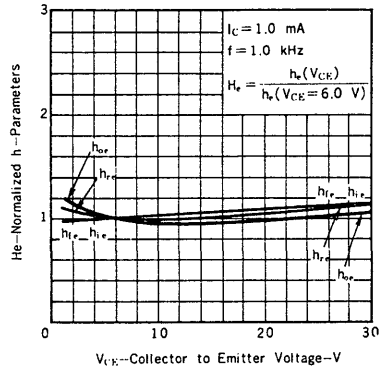

e_n AND i_n vs. COLLECTOR CURRENT

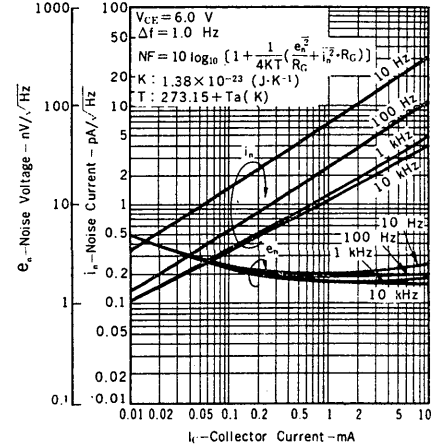

NOISE VOLTAGE TEST CIRCUIT

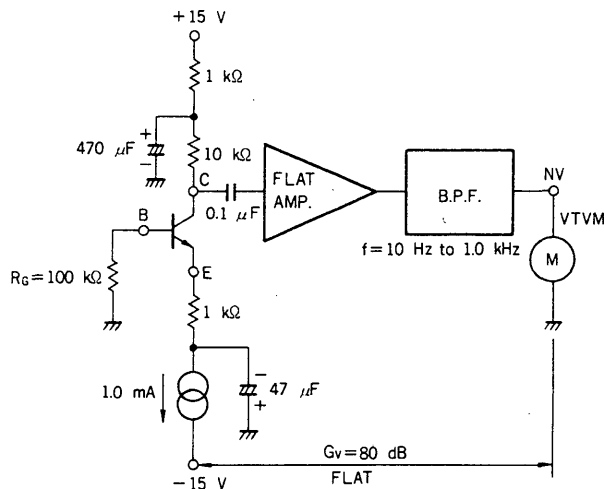

$V_{CE} \approx 5$ V, $I_C = 1.0$ mA, $R_G = 100$ kΩ, $G_v = 80$ dB, FLAT ($f = 10$ Hz to 1.0 kHz)