

**DESCRIPTION** The 2SC1845 is the best for use as the middle range amplifier in Hi-Fi stereo control amplifiers, power amplifiers, and etc.

- FEATURES**
- High Voltage.  $V_{CEO} : 120 \text{ V}$
  - Low Output Capacitance.  $C_{ob} : 1.6 \text{ pF TYP. } (V_{CB} = 30 \text{ V})$
  - High  $h_{FE}$ .  $h_{FE} : 600 \text{ TYP. } (V_{CE} = 6.0 \text{ V, } I_C = 1.0 \text{ mA})$
  - Super Low Noise.  $NV : 25 \text{ mV TYP. (See test Circuit.)}$

**ABSOLUTE MAXIMUM RATINGS**

- Maximum Temperatures
- Storage Temperature .....  $-55 \text{ to } +125 \text{ }^\circ\text{C}$
  - Junction Temperature .....  $+125 \text{ }^\circ\text{C Maximum}$
- Maximum Power Dissipation ( $T_a = 25 \text{ }^\circ\text{C}$ )
- Total Power Dissipation .....  $500 \text{ mW}$
- Maximum Voltages and Currents ( $T_a = 25 \text{ }^\circ\text{C}$ )
- $V_{CBO}$  Collector to Base Voltage .....  $120 \text{ V}$
  - $V_{CEO}$  Collector to Emitter Voltage .....  $120 \text{ V}$
  - $V_{EBO}$  Emitter to Base Voltage .....  $5.0 \text{ V}$
  - $I_C$  Collector Current .....  $50 \text{ mA}$
  - $I_B$  Base Current .....  $10 \text{ mA}$

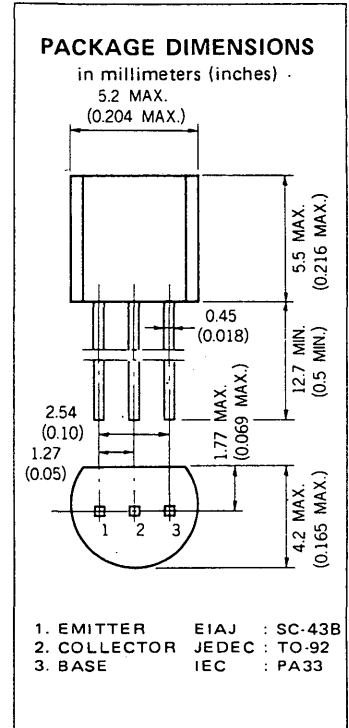

**ELECTRICAL CHARACTERISTICS ( $T_a = 25 \text{ }^\circ\text{C}$ )**

SYMBOL	CHARACTERISTIC	MIN.	TYP.	MAX.	UNIT	TEST CONDITIONS
$h_{FE1}$	DC Current Gain	150	580		—	$V_{CE} = 6.0 \text{ V, } I_C = 0.1 \text{ mA}$
$h_{FE2}$	DC Current Gain	200	600	1200	—	$V_{CE} = 6.0 \text{ V, } I_C = 1.0 \text{ mA}$
$f_T$	Gain Bandwidth Product	50	110		MHz	$V_{CE} = 6.0 \text{ V, } I_E = -1.0 \text{ mA}$
$C_{ob}$	Output Capacitance		1.6	2.5	pF	$V_{CB} = 30 \text{ V, } I_E = 0, f = 1.0 \text{ MHz}$
NV	Noise Voltage		25	40	mV	$V_{CE} = 5.0 \text{ V, } I_C = 1.0 \text{ mA, } R_G = 100 \text{ k}\Omega$ $G_v = 80 \text{ dB, } f = 10 \text{ Hz to } 1.0 \text{ kHz}$
$I_{CBO}$	Collector Cutoff Current			50	nA	$V_{CB} = 120 \text{ V, } I_E = 0$
$I_{EBO}$	Emitter Cutoff Current			50	nA	$V_{EB} = 5.0 \text{ V, } I_C = 0$
$V_{BE}$	Base to Emitter Voltage	0.55	0.59	0.65	V	$V_{CE} = 6.0 \text{ V, } I_C = 1.0 \text{ mA}$
$V_{CE(sat)}$	Collector Saturation Voltage		0.07	0.30	V	$I_C = 10 \text{ mA, } I_B = 1.0 \text{ mA}$

**Classification of  $h_{FE2}$**

Rank	P	F	E	U
Range	200 - 400	300 - 600	400 - 800	600 - 1200

$h_{FE}$  Test Conditions :  $V_{CE} = 6.0 \text{ V, } I_C = 1.0 \text{ mA}$

TYPICAL CHARACTERISTICS (Ta = 25 °C unless otherwise noted)

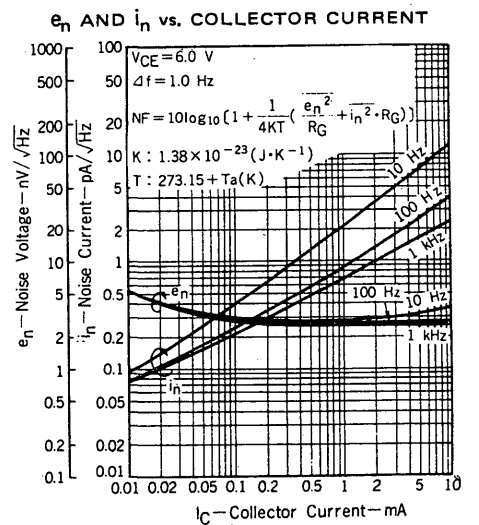
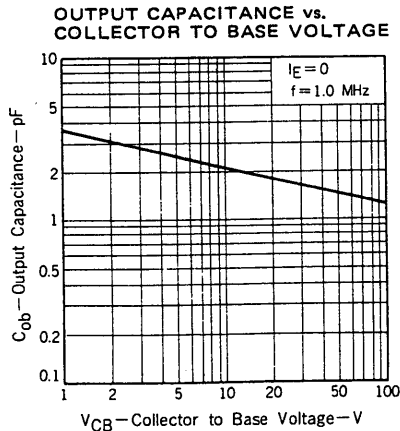
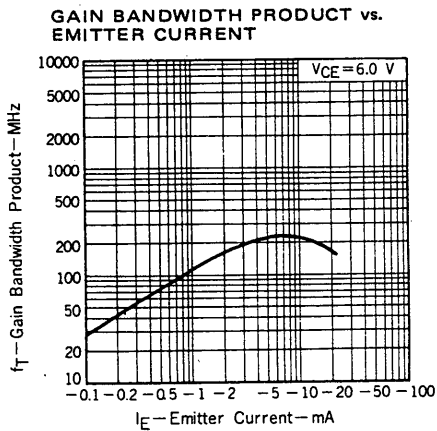
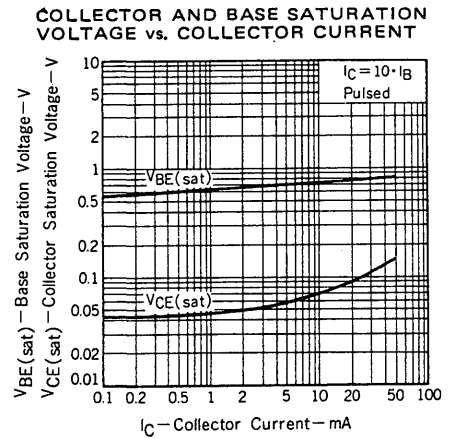
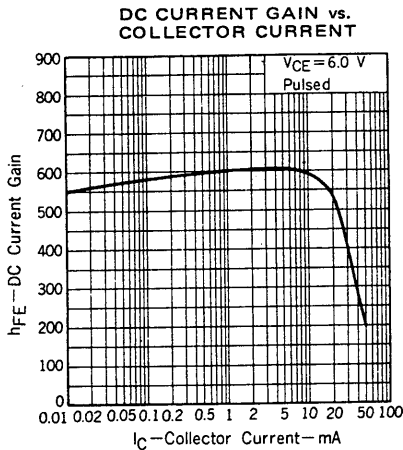
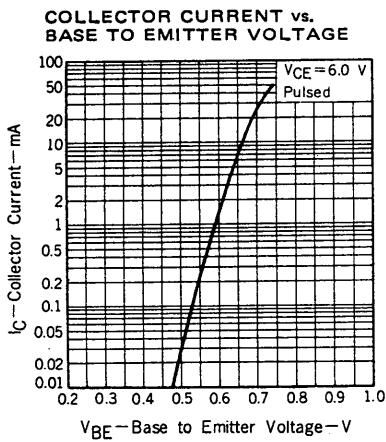
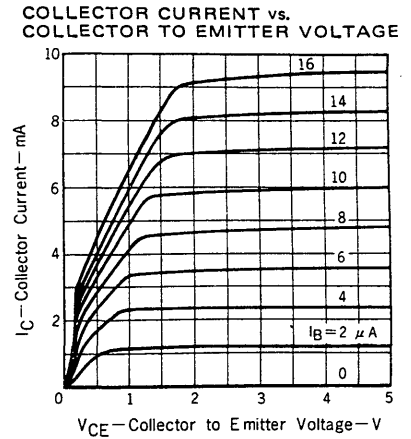
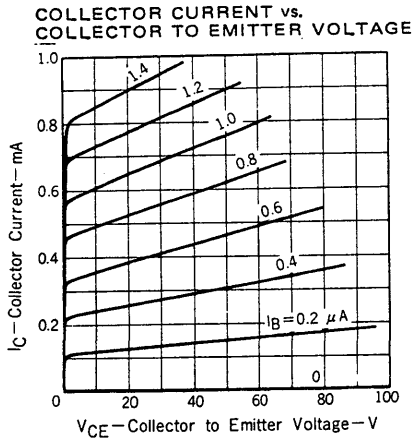
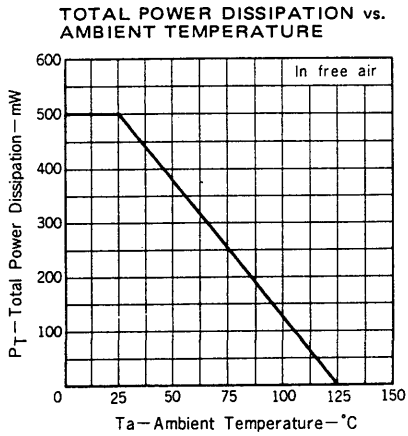

NOISE FIGURE MAP.

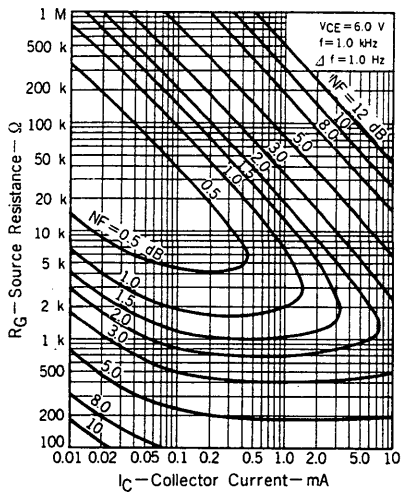

NOISE VOLTAGE TEST CIRCUIT

