

HIGH FREQUENCY AMPLIFIER
NPN SILICON EPITAXIAL TRANSISTOR
MINI MOLD

PACKAGE DIMENSIONS
in millimeters

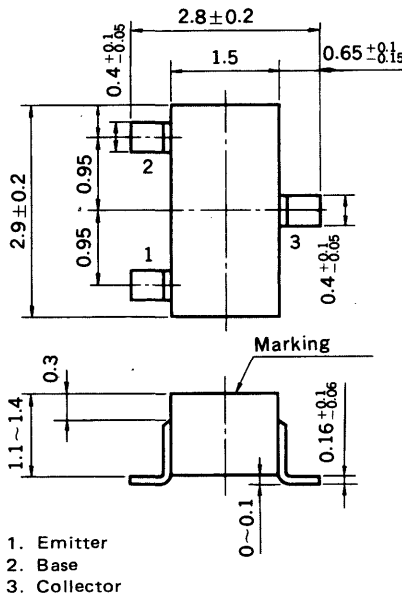

FEATURES

- High Speed: $t_{stg} < 200$ ns
- Complementary to 2SA1461

ABSOLUTE MAXIMUM RATINGS

Maximum Voltages and Current ($T_a = 25^\circ\text{C}$)

Collector to Base Voltage	V_{CBO}	60	V
Collector to Emitter Voltage	V_{CEO}	40	V
Emitter to Base Voltage	V_{EBO}	6	V
Collector Current (DC)	I_C	200	mA

Maximum Power Dissipation

Total Power Dissipation at 25°C Ambient Temperature	P_T	200	mW
--	-------	-----	----

Maximum Temperatures

Junction Temperature	T_j	150	$^\circ\text{C}$
Storage Temperature Range	T_{stg}	-55 to +150	$^\circ\text{C}$

ELECTRICAL CHARACTERISTICS ($T_a = 25^\circ\text{C}$)

CHARACTERISTIC	SYMBOL	MIN.	TYP.	MAX.	UNIT	TEST CONDITIONS
Collector Cutoff Current	I_{CBO}			100	nA	$V_{CB} = 30$ V, $I_E = 0$
Emitter Cutoff Current	I_{EBO}			100	nA	$V_{EB} = 3.0$ V, $I_C = 0$
DC Current Gain	h_{FE1}^*	75	200	300		$V_{CE} = 1.0$ V, $I_C = 10$ mA
DC Current Gain	h_{FE2}^*	25	80			$V_{CE} = 1.0$ V, $I_C = 100$ mA
Collector Saturation Voltage	$V_{CE(sat)}^*$		0.12	0.3	V	$I_C = 50$ mA, $I_B = 5.0$ mA
Base Saturation Voltage	$V_{BE(sat)}^*$		0.80	0.95	V	$I_C = 50$ mA, $I_B = 5.0$ mA
Gain Bandwidth Product	f_T	300	510		MHz	$V_{CE} = 20$ V, $I_E = -10$ mA
Output Capacitance	C_{ob}		3.0	4.0	pF	$V_{CB} = 5.0$ V, $I_E = 0$, $f = 1.0$ MHz
Turn-on Time	t_{on}			70	ns	$V_{CC} = 3.0$ V
Storage Time	t_{stg}		100	200	ns	$I_C = 10$ mA
Turn-off Time	t_{off}			250	ns	$I_{B1} = -I_{B2} = 1.0$ mA

* Pulsed: $PW \leq 350$ μs , Duty Cycle $\leq 2\%$

h_{FE} Classification

Marking	B22	B23	B24
h_{FE1}	75 to 150	100 to 200	150 to 300

SWITCHING TIME TEST CIRCUIT

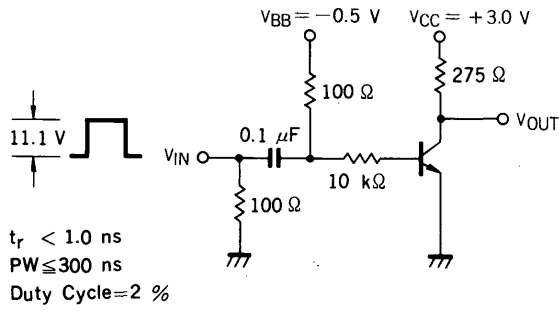

t_{on} SWITCHING

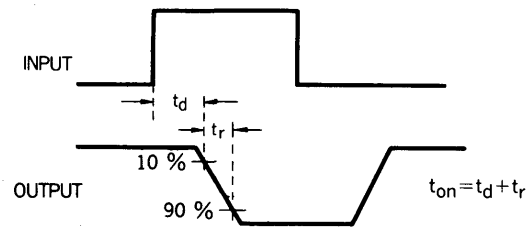

VOLTAGE WAVEFORMS

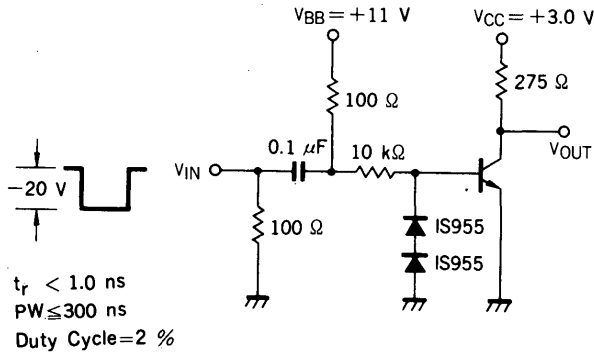

t_{off} SWITCHING

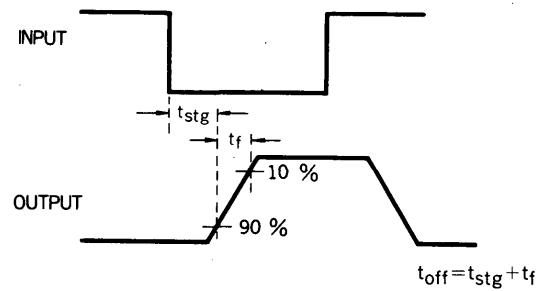

VOLTAGE WAVEFORMS

TYPICAL CHARACTERISTICS ($T_a = 25^\circ\text{C}$)

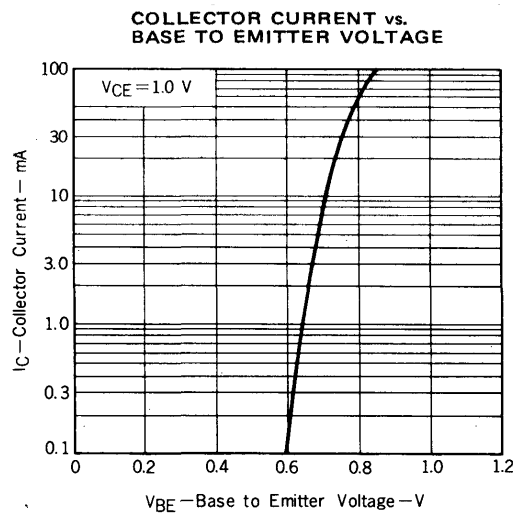
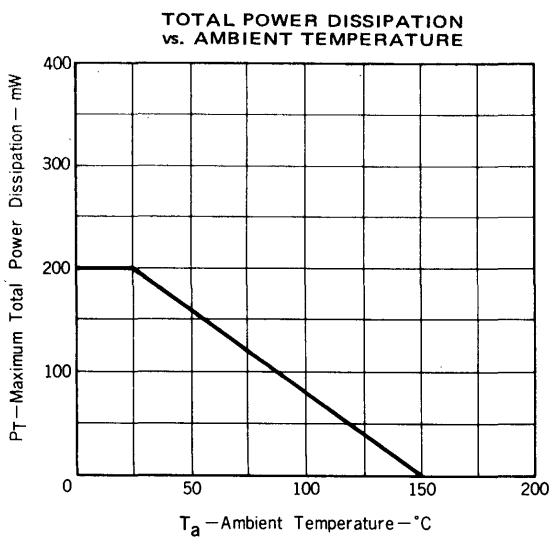

COLLECTOR CURRENT vs. COLLECTOR TO EMITTER VOLTAGE

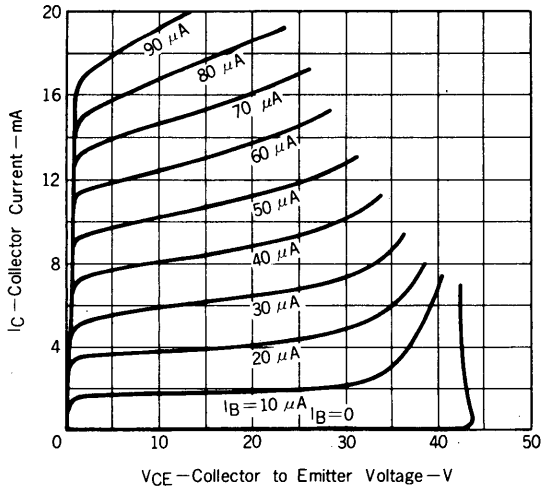

COLLECTOR CURRENT vs. COLLECTOR TO EMITTER VOLTAGE

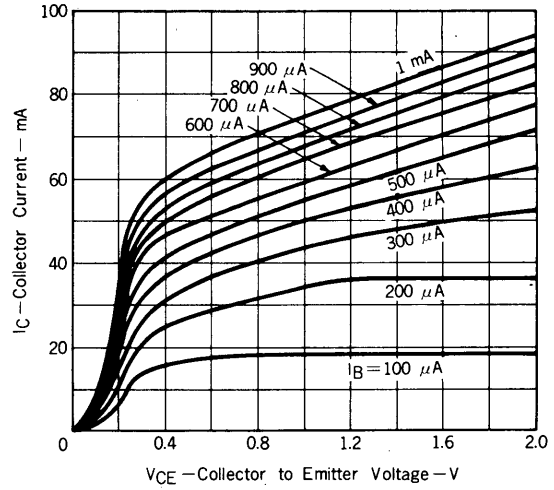

DC CURRENT GAIN vs. COLLECTOR CURRENT

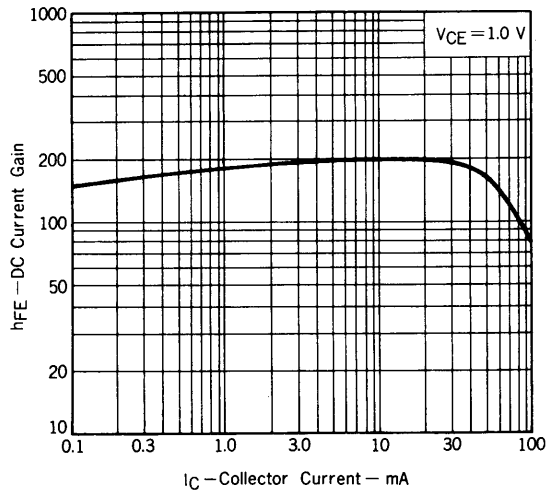

BASE AND COLLECTOR SATURATION VOLTAGE vs. COLLECTOR CURRENT

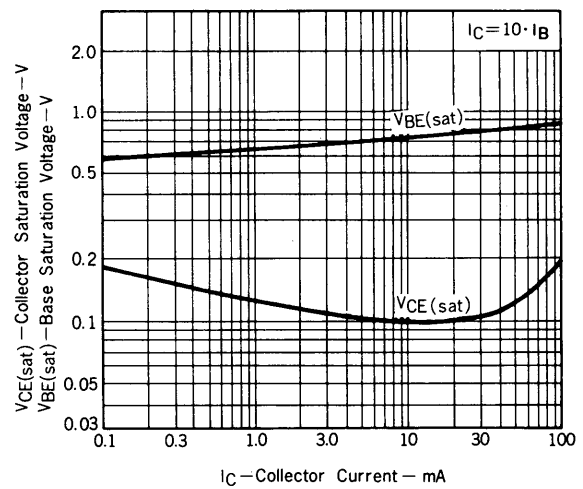

GAIN BANDWIDTH PRODUCT vs. EMITTER CURRENT

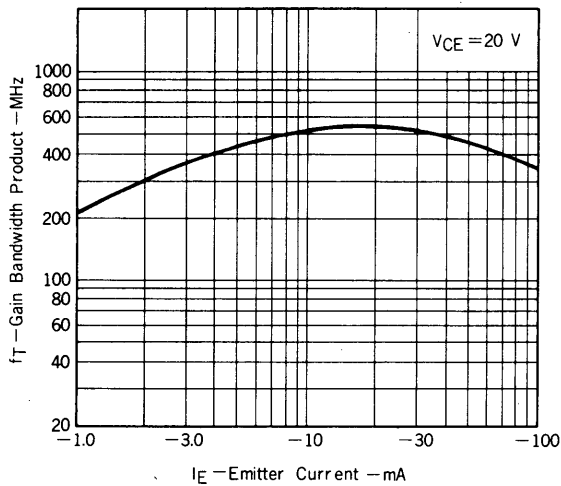

INPUT AND OUTPUT CAPACITANCE vs. REVERSE VOLTAGE

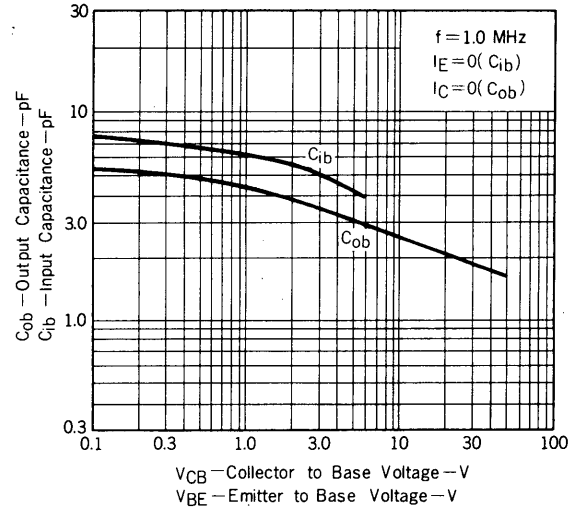

TURN-ON TIME vs. COLLECTOR CURRENT

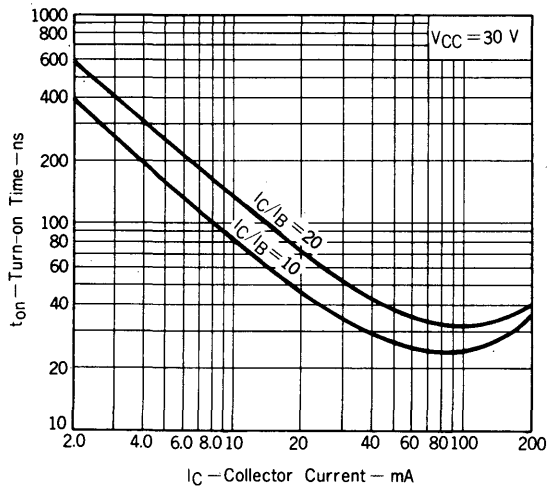

RISE TIME vs. COLLECTOR CURRENT

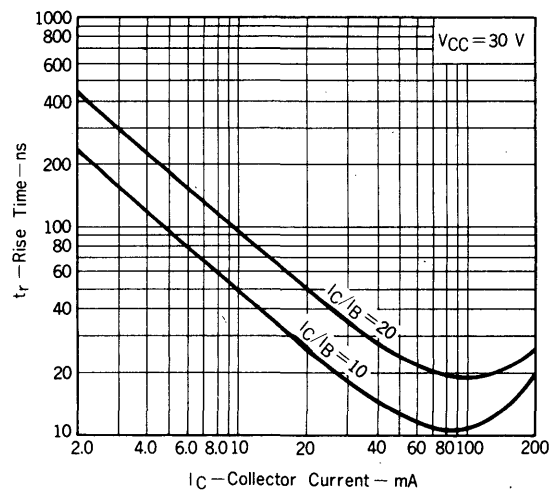

STORAGE TIME vs. COLLECTOR CURRENT

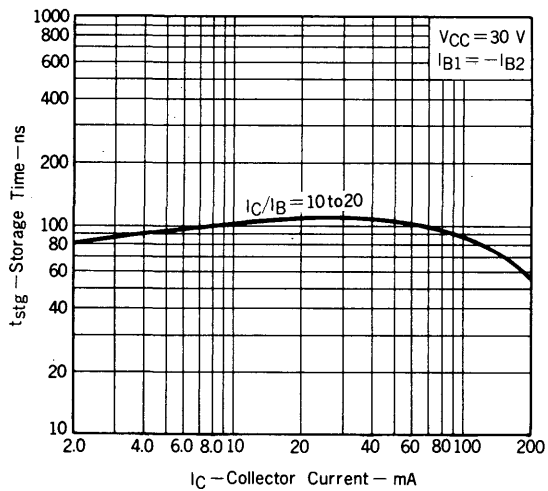

FALL TIME vs. COLLECTOR CURRENT

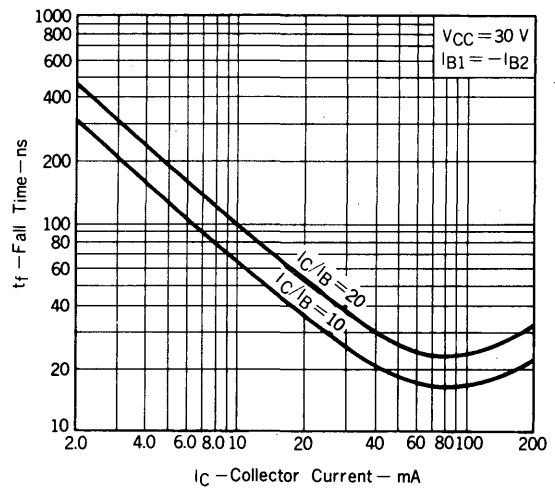

NEC Corporation

INTERNATIONAL ELECTRON DEVICES DIV.
 SUMITOMO MITA Building, 37-8,
 Shiba Gochome, Minato-ku, Tokyo 108, Japan
 Tel: Tokyo 456-3111
 Telex Address: NECTOK J22686
 Cable Address: NEC TOKYO