

P-CHANNEL MOS FIELD EFFECT POWER TRANSISTOR  
**2SJ331**

SWITCHING  
 P-CHANNEL POWER MOS FET  
 INDUSTRIAL USE

**DESCRIPTION**

The 2SJ331 is P-channel MOS Field Effect Transistor designed for solenoid, motor and lamp driver.

**FEATURES**

- Low On-state Resistance  
 $R_{DS(on)} \leq 26 \text{ m}\Omega \text{ MAX. (} V_{GS} = -10 \text{ V, } I_D = -15 \text{ A)}$   
 $R_{DS(on)} \leq 40 \text{ m}\Omega \text{ MAX. (} V_{GS} = -4 \text{ V, } I_D = -12 \text{ A)}$
- Low  $C_{iss}$   $C_{iss} = 4 \text{ 300 pF TYP.}$
- Built-in G-S Gate Protection Diodes

**QUALITY GRADE**

Standard

Please refer to "Quality grade on NEC Semiconductor Devices" (Document number IEI-1209) published by NEC Corporation to know the specification of quality grade on the devices and its recommended applications.

**ABSOLUTE MAXIMUM RATINGS ( $T_a = 25 \text{ }^\circ\text{C}$ )**

Drain to Source Voltage	$V_{DSS}$	-60	V
Gate to Source Voltage	$V_{GSS(AC)}$	$\mp 20$	V
Gate to Source Voltage	$V_{GSS(DC)}$	-20, +10	V
Drain Current (DC)	$I_{D(DC)}$	$\mp 30$	A
Drain Current (pulse)	$I_{D(pulse)^*}$	$\mp 120$	A
Total Power Dissipation ( $T_c = 25 \text{ }^\circ\text{C}$ ) $P_{T1}$		150	W
Total Power Dissipation ( $T_a = 25 \text{ }^\circ\text{C}$ ) $P_{T2}$		3.0	W
Channel Temperature	$T_{ch}$	150	$^\circ\text{C}$
Storage Temperature	$T_{stg}$	-55 to +150	$^\circ\text{C}$

\*  $PW \leq 10 \mu\text{s}$ , Duty Cycle  $\leq 1 \%$

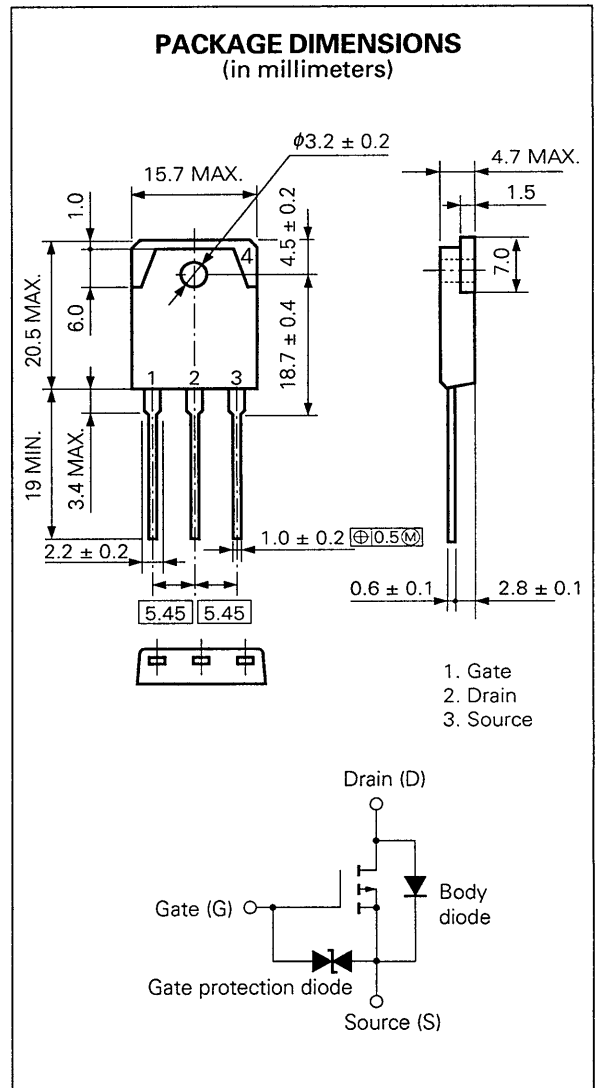

**ELECTRICAL CHARACTERISTICS (T<sub>a</sub> = 25 °C)**

CHARACTERISTIC	SYMBOL	MIN.	TYP.	MAX.	UNIT	TEST CONDITIONS
Drain to Source On-state Resistance	R <sub>DS(on)</sub>		26	30	mΩ	V <sub>GS</sub> = -10 V, I <sub>D</sub> = -15 A
Drain to Source On-state Resistance	R <sub>DS(on)</sub>		40	55	mΩ	V <sub>GS</sub> = -4 V, I <sub>D</sub> = -12 A
Gate to Source Cutoff Voltage	V <sub>GS(off)</sub>	-1.0	-1.5	-2.0	V	V <sub>DS</sub> = -10 V, I <sub>D</sub> = -1 mA
Forward Transfer Admittance	y <sub>fs</sub>	15	23		S	V <sub>DS</sub> = -10 V, I <sub>D</sub> = -15 A
Drain Leakage Current	I <sub>DSS</sub>			-10	μA	V <sub>DS</sub> = -60 V, V <sub>GS</sub> = 0
Gate to Source Leakage Current	I <sub>GSS</sub>			±10	μA	V <sub>GS</sub> = ±16 V, V <sub>DS</sub> = 0
Input Capacitance	C <sub>iss</sub>		4 300		pF	V <sub>DS</sub> = -10 V V <sub>GS</sub> = 0 f = 1 MHz
Output Capacitance	C <sub>oss</sub>		2 300		pF	
Reverse Transfer Capacitance	C <sub>rss</sub>		1 100		pF	
Turn-On Delay Time	t <sub>d(on)</sub>		60		ns	V <sub>GS(on)</sub> = -10 V V <sub>DD</sub> = -30 V I <sub>D</sub> = -15 A, R <sub>G</sub> = 10 Ω R <sub>L</sub> = 2.0 Ω
Rise Time	t <sub>r</sub>		320		ns	
Turn-Off Delay Time	t <sub>d(off)</sub>		490		ns	
Fall Time	t <sub>f</sub>		470		ns	
Total Gate Charge	Q <sub>G</sub>		160		nC	V <sub>GS</sub> = -10 V I <sub>D</sub> = -30 A V <sub>DD</sub> = -48 V
Gate to Source Charge	Q <sub>GS</sub>		12		nC	
Gate to Drain Charge	Q <sub>GD</sub>		66		nC	
Diode Forward Voltage	V <sub>SD</sub>		1.1		V	I <sub>F</sub> = 30 A, V <sub>GS</sub> = 0
Reverse Recovery Time	t <sub>rr</sub>		150		ns	I <sub>F</sub> = 30 A, V <sub>GS</sub> = 0
Reverse Recovery Charge	Q <sub>rr</sub>		300		nC	di/dt = 50 A/μs

**Test Circuit 1: Switching Time**

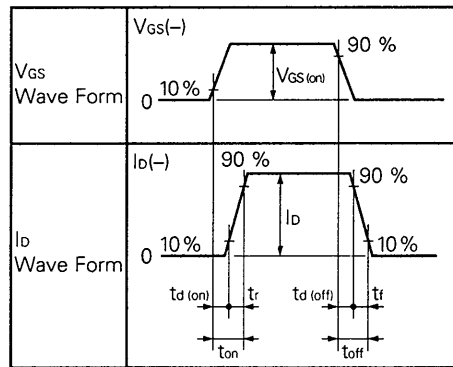
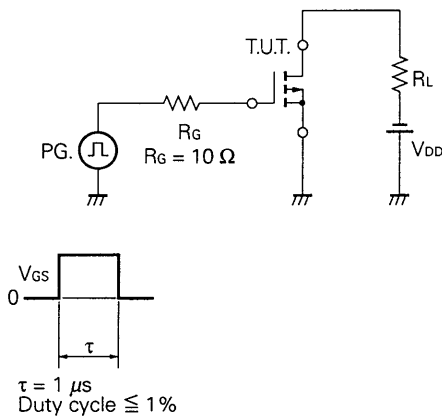

**Test Circuit 2: Gate Charge**

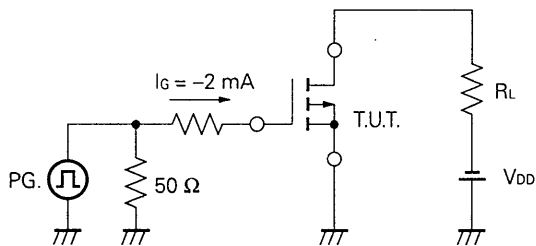

ELECTRICAL CHARACTERISTICS (T<sub>a</sub> = 25 °C)

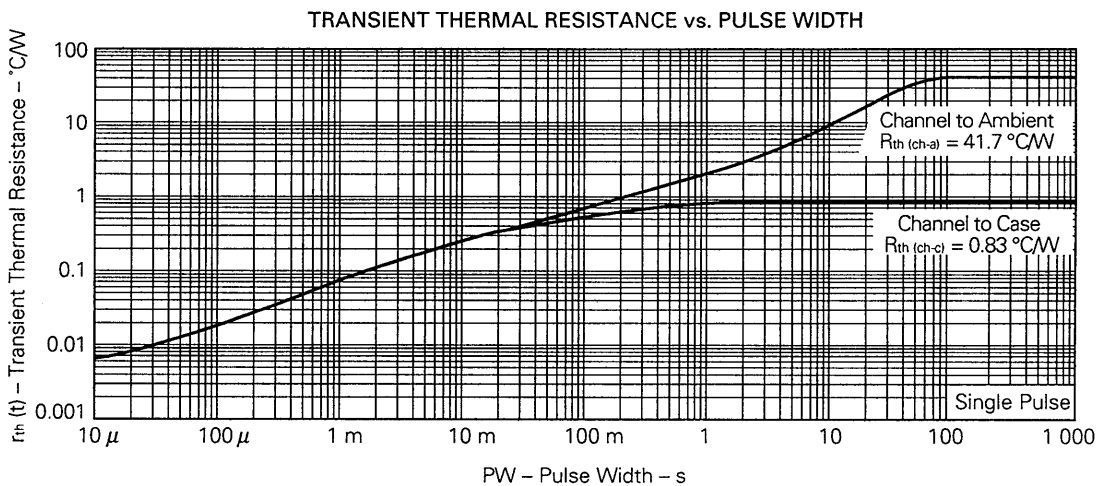
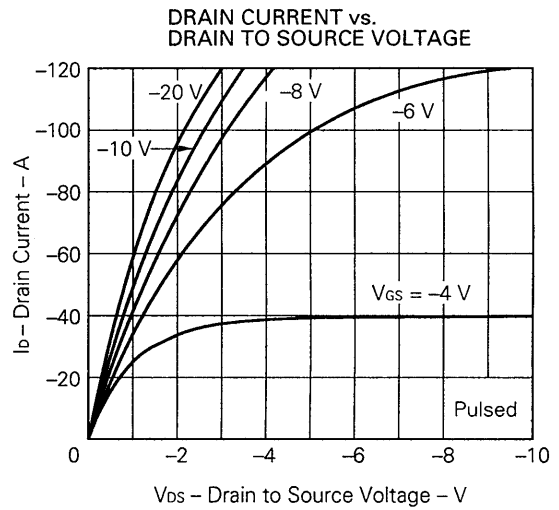
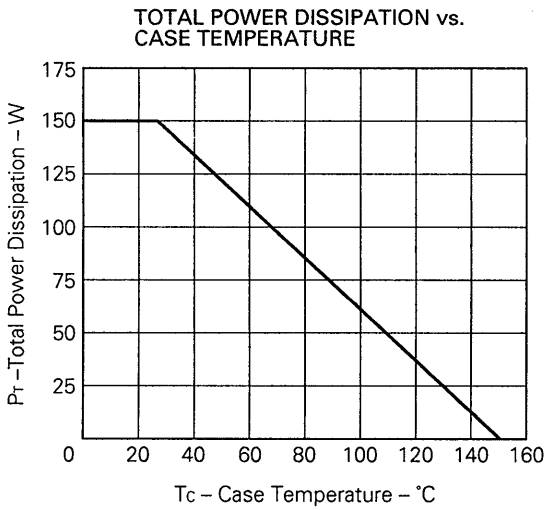
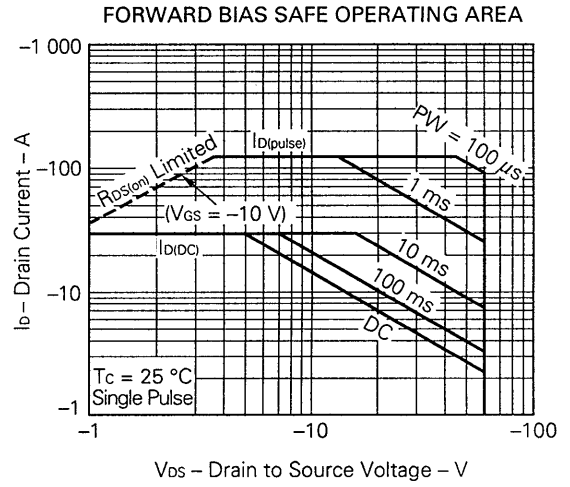
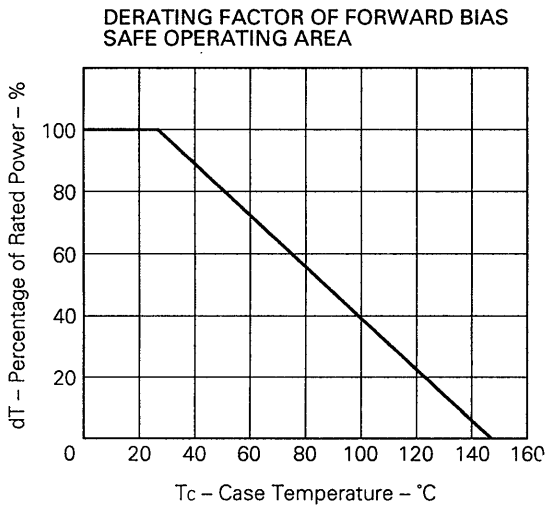

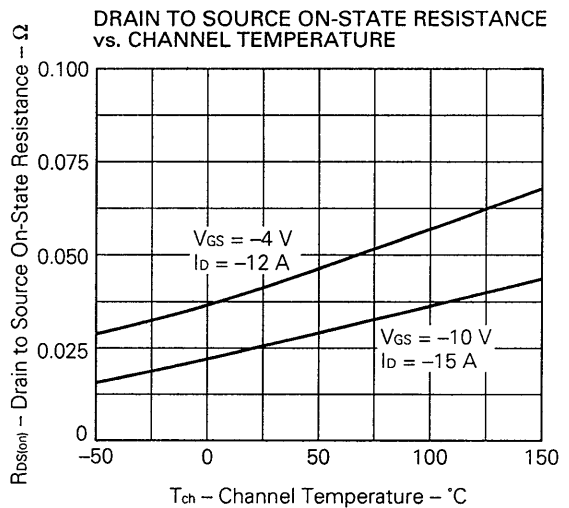
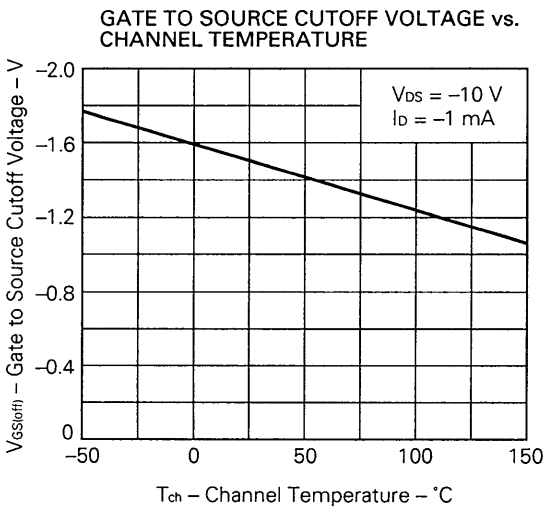
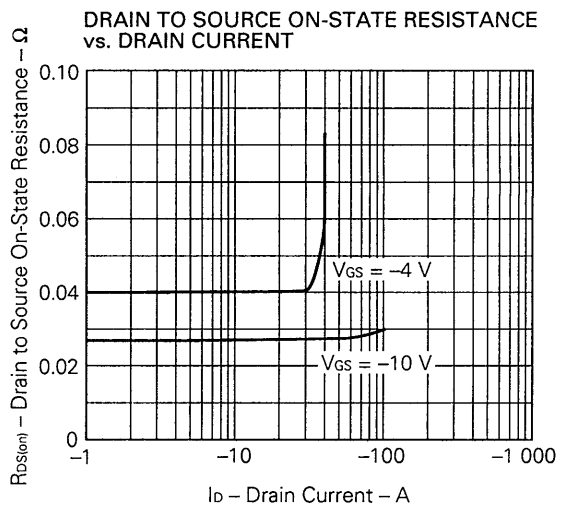
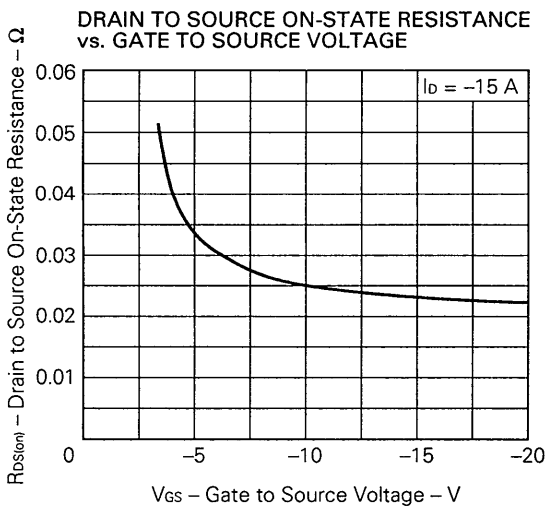
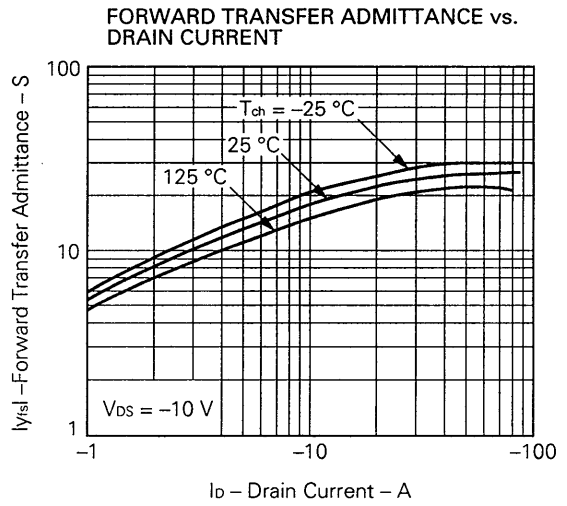
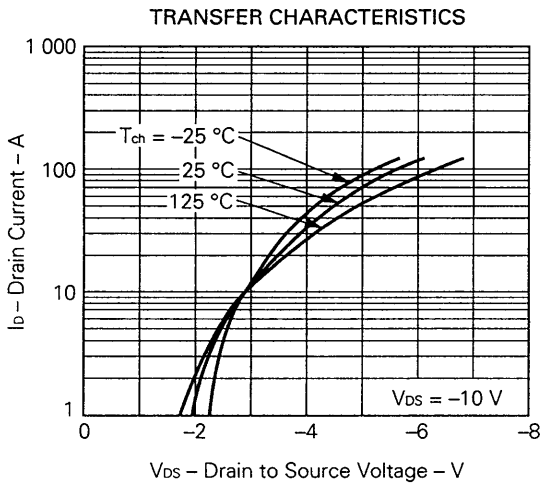

SOURCE TO DRAIN DIODE FORWARD VOLTAGE

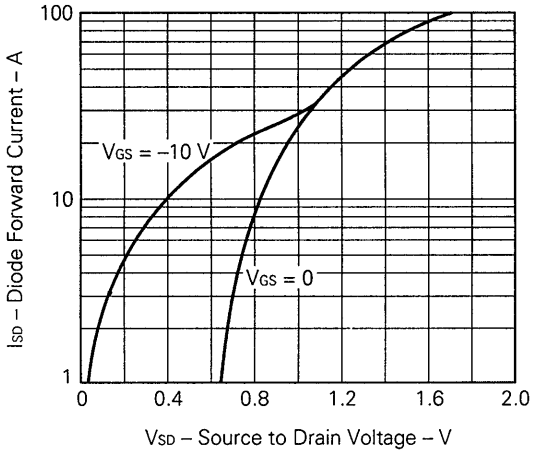

CAPACITANCE vs. DRAIN TO SOURCE VOLTAGE

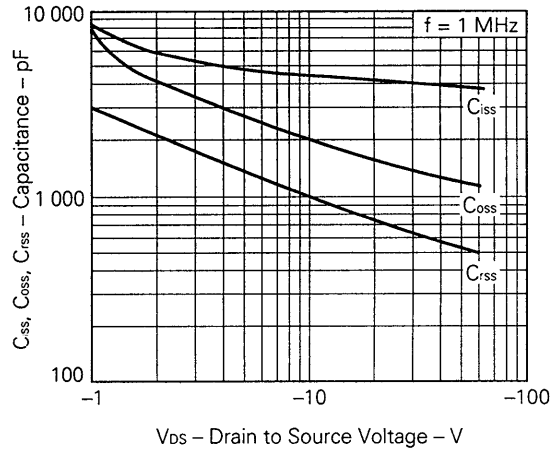

SWITCHING CHARACTERISTICS

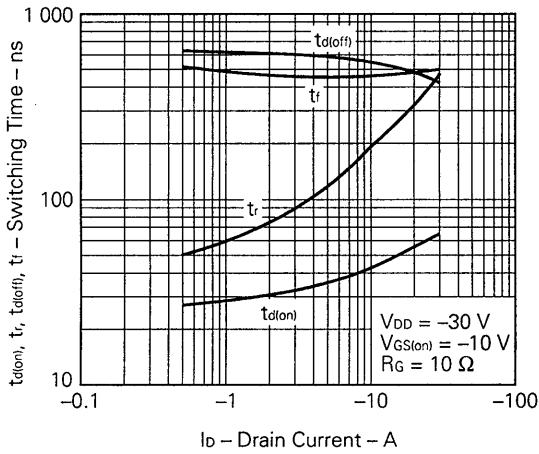

DYNAMIC INPUT/OUTPUT CHARACTERISTICS

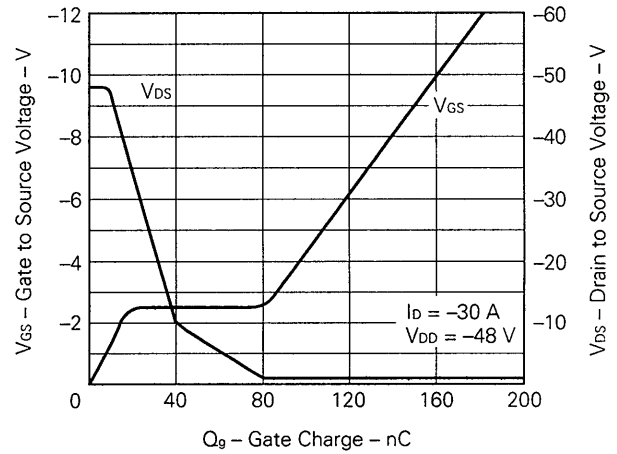

REVERSE RECOVERY TIME vs. REVERSE DRAIN CURRENT

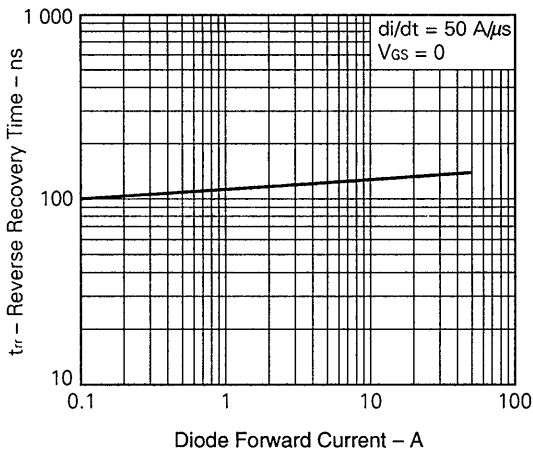

**Reference**

Application note name	No.
Safe operating area of Power MOS FET.	TEA-1034
Application circuit using Power MOS FET.	TEA-1035
Quality control of NEC semiconductors devices.	TEI-1202
Quality control guide of semiconductors devices.	MEI-1202
Assembly manual of semiconductors devices.	IEI-1207

No part of this document may be copied or reproduced in any form or by any means without the prior written consent of NEC Corporation. NEC Corporation assumes no responsibility for any errors which may appear in this document.

NEC Corporation does not assume any liability for infringement of patents, copyrights or other intellectual property rights of third parties by or arising from use of a device described herein or any other liability arising from use of such device. No license, either express, implied or otherwise, is granted under any patents, copyrights or other intellectual property rights of NEC Corporation or others.

The devices listed in this document are not suitable for use in aerospace equipment, submarine cables, nuclear reactor control systems and life support systems. If customers intend to use NEC devices for above applications or they intend to use "Standard" quality grade NEC devices for applications not intended by NEC, please contact our sales people in advance.

Application examples recommended by NEC Corporation.

Standard: Computer, Office equipment, Communication equipment, Test and Measurement equipment, Machine tools, Industrial robots, Audio and Visual equipment, Other consumer products, etc.

Special: Automotive and Transportation equipment, Traffic control systems, Antidisaster systems, Anticrime systems, etc.