

FEATURES

- **HIGH INSERTION GAIN:** 18.5 dB at 500 MHz
- **LOW NOISE FIGURE:** 1.5 dB at 500 MHz
- **HIGH POWER GAIN:** 12 dB at 2 GHz
- **LARGE DYNAMIC RANGE:** 19 dBm at 1 dB, 2 GHz Gain Compression

DESCRIPTION

NEC's NE021 series of NPN silicon transistors provides economical solutions to wide ranges of amplifier and oscillator problems. Low noise and high current capability provide low intermodulation distortion. The NE021 series is available as a chip or in several package styles. The series uses the NEC gold, platinum, titanium, and platinum-silicide metallization system to provide the utmost in reliability. NE02107 is available in both common-base and common-emitter configurations and has been qualified for high-reliability space applications.

NE02135

TYPICAL NOISE PARAMETERS (T_A = 25°C)

FREQ. (MHz)	NF _{OPT} (dB)	GA (dB)	Γ _{OPT}		Rn/50
			MAG	ANG	
V_{CE} = 10 V, I_c = 5 mA					
500	1.2	18.60	.36	69	.14
1000	1.5	13.82	.31	124	.12
1500	2.0	11.83	.50	165	.05
2000	2.4	9.36	.44	-175	.06
2500	2.6	7.82	.52	-161	.10
3000	3.6	7.51	.68	-141	.14
3500	3.7	6.31	.71	-139	.21
V_{CE} = 10 V, I_c = 20 mA					
500	1.8	21.32	.16	149	.15
1000	1.9	16.15	.33	169	.13
1500	2.4	13.50	.46	-179	.09
2000	2.9	11.02	.53	-167	.08
2500	3.2	9.12	.57	-154	.14
3000	3.9	8.10	.62	-139	.27
3500	4.3	6.48	.67	-134	.42

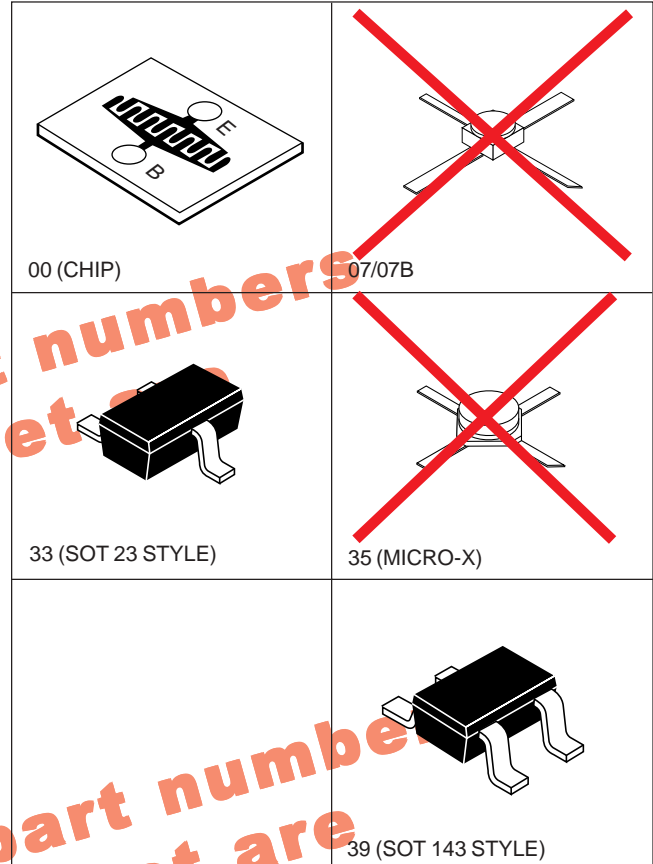

NE02139

TYPICAL NOISE PARAMETERS (T_A = 25°C)

FREQ. (MHz)	NF _{OPT} (dB)	GA (dB)	Γ _{OPT}		Rn/50
			MAG	ANG	
V_{CE} = 10 V, I_c = 20 mA					
500	1.8	17.5	0.11	156	.20
1000	2.1	12.5	0.27	168	.16
1500	2.3	9.5	0.36	-156	.18
2000	2.6	7.5	0.43	-147	.21

NE021 SERIES

ELECTRICAL CHARACTERISTICS (T_A = 25°C)

PART NUMBER EIAJ ¹ REGISTERED NUMBER PACKAGE OUTLINE			NE02100 00 (CHIP)			NE02107 07/07B ³		
SYMBOLS	PARAMETERS AND CONDITIONS	UNITS	MIN	TYP	MAX	MIN	TYP	MAX
f _T	Gain Bandwidth Product at V _{CE} = 10 V, I _C = 20 mA	GHz		4.5			4.5	
S ₂₁ ²	Insertion Power Gain at V _{CE} = 10 V, I _C = 20 mA, f = 0.5 GHz	dB		18.5			18.5	
	f = 1 GHz	dB		13			13	
	f = 2 GHz	dB	5.5	6.5		5.5	6.5	
NF _{MIN}	Minimum Noise Figure ² at V _{CE} = 10 V, I _C = 3 mA, f = 0.5 GHz	dB		1.5			1.5	
	V _{CE} = 10 V, I _C = 5 mA, f = 2 GHz	dB		2.7	4.5		2.7	4.5
I _{CBO}	Collector Cutoff Current at V _{CB} = 15 V, I _E = 0	μA			1.0			1.0
I _{EBO}	Emitter Cutoff Current at V _{EB} = 2 V, I _C = 0	μA			1.0			1.0
h _{FE}	Forward Current Gain at V _{CE} = 10 V, I _C = 20 mA		20	70	250	20	70	250
C _{CB}	Collector to Base Capacitance ⁴ at V _{CB} = 10 V, I _E = 0, f = 1 MHz	pF		0.6	1.0		0.6	1.0
R _{TH (J-C)}	Thermal Resistance (Junction to Case)	°C/W			70			90
R _{TH (J-A)}	Thermal Resistance (Junction to Ambient)	°C/W						500
P _T ⁵	Total Power Dissipation	mW	580		700	350		700

ELECTRICAL CHARACTERISTICS (T_A = 25°C)

PART NUMBER EIAJ ¹ REGISTERED NUMBER PACKAGE OUTLINE			NE02133 2SC2351 33			NE02135 2SC2149 35			NE02139 2SC4092 39		
SYMBOLS	PARAMETERS AND CONDITIONS	UNITS	MIN	TYP	MAX	MIN	TYP	MAX	MIN	TYP	MAX
f _T	Gain Bandwidth Product at V _{CE} = 10 V, I _C = 20 mA	GHz		4.5			4.5			4.5	
S _{21E} ²	Insertion Power Gain at V _{CE} = 10 V, I _C = 20 mA, f = 0.5 GHz	dB		15			18.5				
	f = 1 GHz	dB	9	10			13		9	10	
	f = 2 GHz	dB	4	5		5	5.7				
NF _{MIN}	Minimum Noise Figure ⁶ at V _{CE} = 10 V, I _C = 3 mA, f = 0.5 GHz	dB					1.5				
	V _{CE} = 10 V, I _C = 5 mA, f = 1 GHz	dB		1.5	3					1.5	
	f = 2 GHz	dB					2.7	4.0			
I _{CBO}	Collector Cutoff Current at V _{CB} = 15 V, I _E = 0	μA			1.0			1.0			1.0
I _{EBO}	Emitter Cutoff Current at V _{EB} = 2 V, I _C = 0	μA			1.0			1.0			1.0
h _{FE}	Forward Current Gain at V _{CE} = 10 V, I _C = 20 mA		40	70	200	20	70	250	40	70	200
C _{CB}	Collector to Base Capacitance ⁴ at V _{CB} = 10 V, I _E = 0, f = 1 MHz	pF		0.75	1.0		0.6	1.0		.75	
R _{TH (J-C)}	Thermal Resistance (Junction to Case)	°C/W						120			
R _{TH (J-A)}	Thermal Resistance (Junction to Ambient)	°C/W			666			600			500
P _T ⁵	Total Power Dissipation	mW			150	290		500			200

Notes:

- Electronic Industrial Association of Japan.
- Input and output are tuned for optimum noise figures.
- Common base electrical characteristics see S-Parameters.
- C_{CB} measurement employs a three-terminal capacitance bridge incorporating a guard circuit. The emitter terminal shall be connected to the guard terminal.
- Minimum dissipations based on R_{TH (J-A)} for applications without effective heat sink, maximum dissipations based on R_{TH (J-C)} for applications with effective heat sink.
- Output and Input are tuned for minimum noise figure.

ABSOLUTE MAXIMUM RATINGS¹ ($T_A = 25^\circ\text{C}$)

SYMBOLS	PARAMETERS	UNITS	RATINGS
V _{CBO}	Collector to Base Voltage	V	25
V _{CEO}	Collector to Emitter Voltage	V	12 ²
V _{EB0}	Emitter to Base Voltage	V	3
I _C	Collector Current	mA	70
T _J	Junction Temperature	°C	200 ³
T _{STG}	Storage Temperature	°C	-65 to +200 ⁴

Notes:

1. Operation in excess of any one of these parameters may result in permanent damage.
2. Typical $BV_{CEr} = 25\text{ V}$ for $R \leq 300\ \Omega$.
3. Maximum T_J for the NE02133 and NE02139 is +150°C.
4. Maximum storage temperature for the NE02135 is -65 to +150°C. Maximum storage temperature for the NE02133 and NE02139 is -55 to 150°C.

TYPICAL PERFORMANCE CURVES ($T_A = 25^\circ\text{C}$)

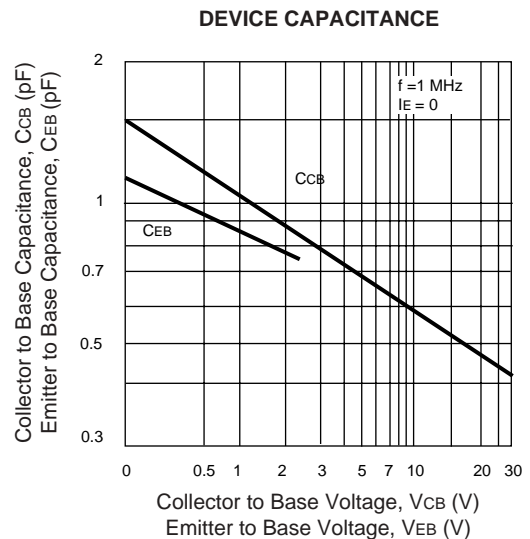
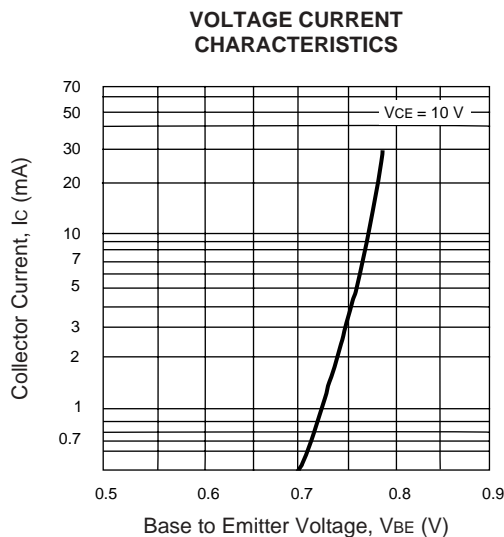
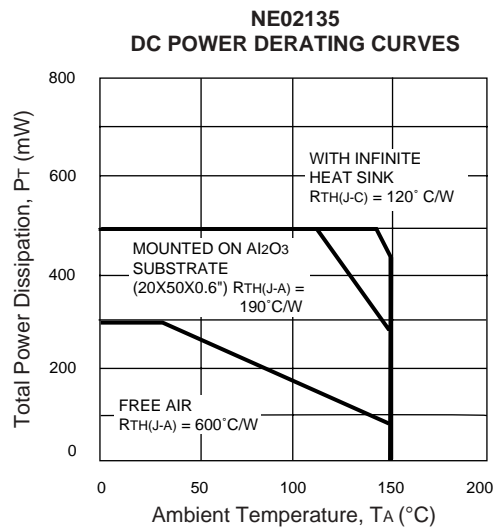
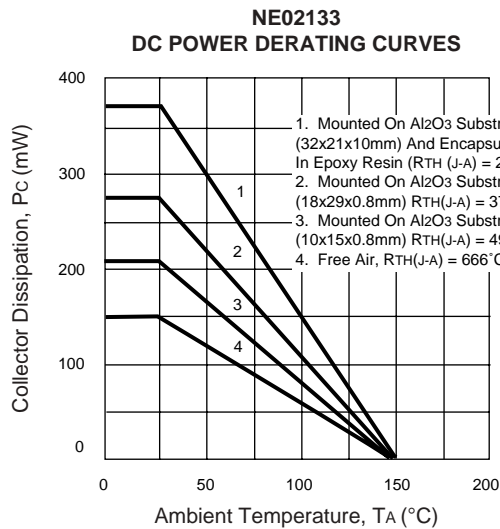
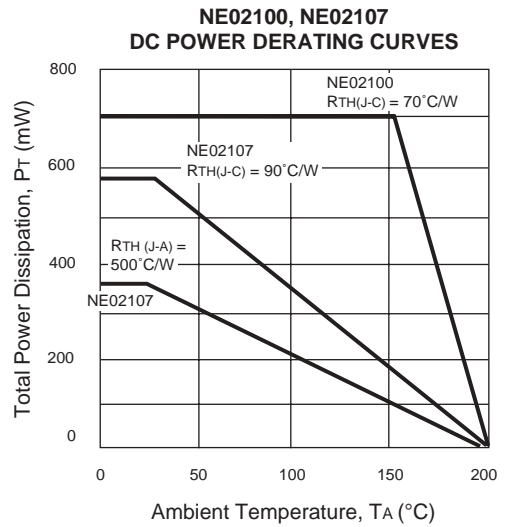

NE021 SERIES

TYPICAL PERFORMANCE CURVES (T_A = 25°C)

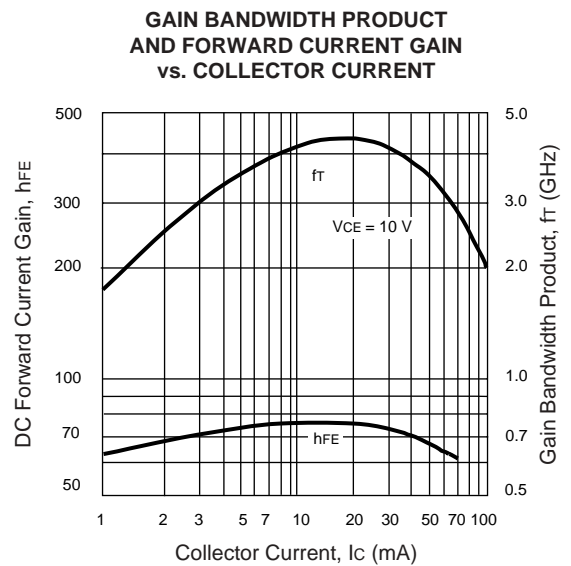
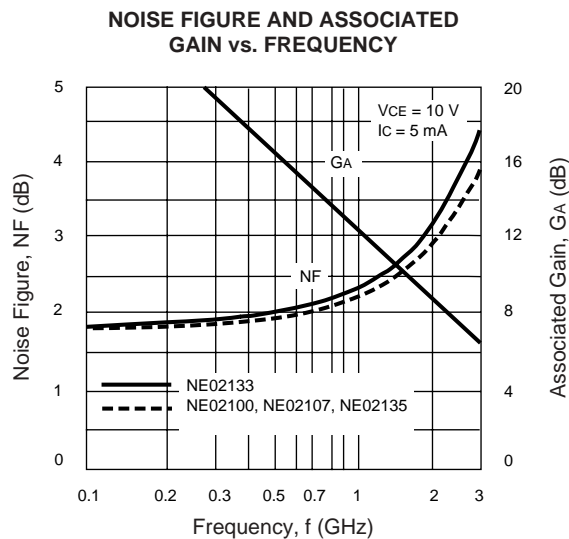
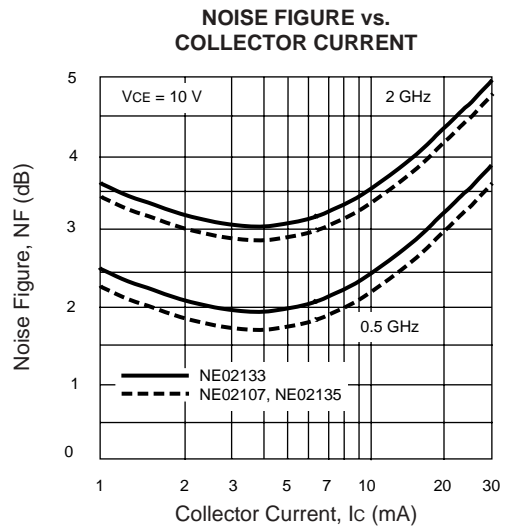
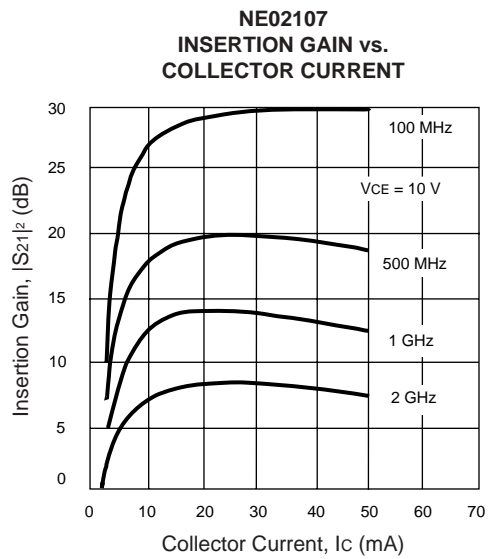
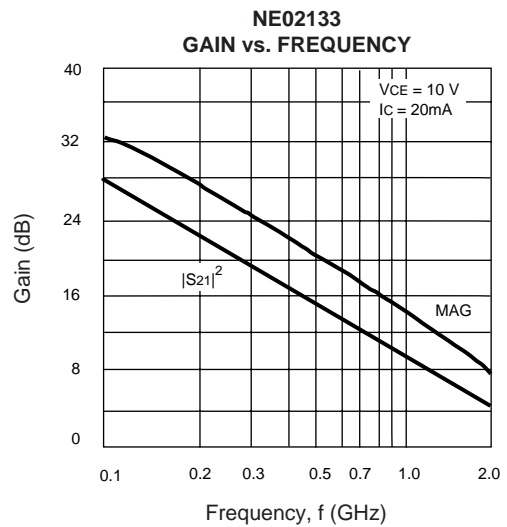
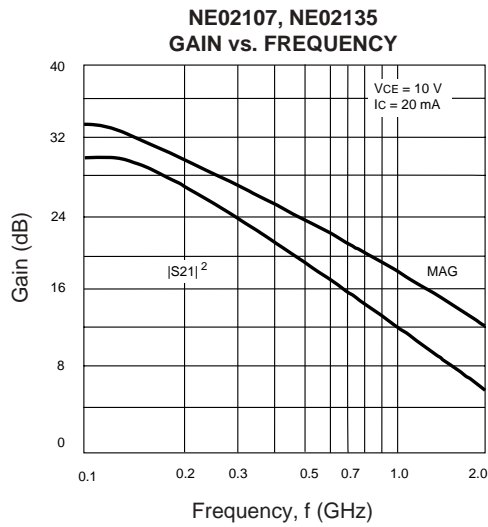

TYPICAL COMMON EMITTER SCATTERING PARAMETERS¹ (T_A = 25°C)

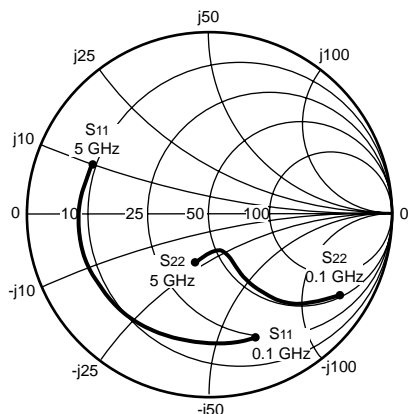

Coordinates in Ohms
Frequency in GHz
(V_{CE} = 10 V, I_c = 20 mA)

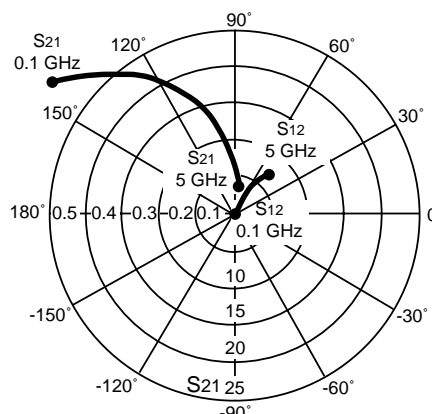

NE02100

V_{CE} = 10 V, I_c = 5 mA

FREQUENCY (MHz)	S ₁₁		S ₂₁		S ₁₂		S ₂₂		K	MAG ² (dB)
	MAG	ANG	MAG	ANG	MAG	ANG	MAG	ANG		
100	.84	-32	11.83	160	.03	70	.94	-16	.11	26.4
500	.75	-114	7.22	113	.07	36	.56	-45	.29	19.9
1000	.73	-150	4.13	89	.09	27	.39	-51	.54	16.9
1500	.71	-164	2.85	76	.09	27	.36	-56	.77	15.0
2000	.71	-173	2.16	66	.10	28	.33	-61	.97	13.5
2500	.71	-179	1.75	57	.10	30	.33	-67	1.14	10.1
3000	.70	176	1.49	49	.11	32	.34	-73	1.25	8.3
3500	.70	172	1.28	42	.12	33	.35	-80	1.35	6.9
4000	.70	168	1.13	34	.12	34	.37	-88	1.41	5.9
4500	.70	165	1.02	27	.13	34	.39	-94	1.47	4.9
5000	.70	161	.92	20	.14	35	.41	-100	1.49	4.2

V_{CE} = 10 V, I_c = 10 mA

100	.75	-47	20.04	153	.02	65	.89	-24	.11	29.2
500	.72	-137	9.40	105	.05	34	.41	-57	.39	22.5
1000	.72	-162	4.97	86	.06	34	.27	-62	.69	19.0
1500	.71	-173	3.37	75	.07	38	.23	-66	.92	16.8
2000	.71	-179	2.56	66	.08	41	.22	-71	1.09	13.2
2500	.71	176	2.05	58	.09	43	.23	-76	1.19	10.9
3000	.71	172	1.74	51	.10	44	.24	-82	1.27	9.2
3500	.71	168	1.50	44	.11	44	.25	-88	1.31	7.9
4000	.70	165	1.33	37	.12	44	.27	-95	1.36	6.8
4500	.70	162	1.19	30	.13	44	.29	-100	1.39	5.9
5000	.70	159	1.08	24	.14	43	.31	-106	1.39	5.1

V_{CE} = 10 V, I_c = 20 mA

100	.68	-70	29.75	145	.02	59	.81	-33	.14	31.6
500	.72	-152	10.58	99	.04	37	.30	-65	.53	24.3
1000	.72	-170	5.42	84	.05	43	.19	-69	.87	20.4
1500	.72	-178	3.65	74	.06	48	.17	-73	1.05	16.4
2000	.72	177	2.74	66	.07	50	.17	-78	1.17	13.2
2500	.72	172	2.21	58	.09	51	.17	-83	1.23	11.3
3000	.71	169	1.86	51	.10	52	.19	-87	1.27	9.7
3500	.71	166	1.61	44	.11	51	.20	-93	1.30	8.4
4000	.71	162	1.42	38	.12	51	.22	-99	1.34	7.3
4500	.71	160	1.28	31	.13	49	.24	-105	1.33	6.4
5000	.71	157	1.15	25	.14	48	.27	-109	1.34	5.6

Notes:

1. S-Parameters include bond wires.

BASE: Total 1 wire (s), 1 per bond pad, 0.0115 (291 μm) long each wire. EMITTER: Total 2 wire (s), 1 per side, 0.015" (393 μm) long each wire.
COLLECTOR: Total 1 wire (s), 1 per bond pad, 0.0072" (182 μm) WIRE: 0.0007" (17.7 μm) dia., gold.
long each wire.

2. Gain Calculations:

$$MAG = \frac{|S_{21}|}{|S_{12}|} (K \pm \sqrt{K^2 - 1}). \text{ When } K \leq 1, \text{ MAG is undefined and MSG values are used. } MSG = \frac{|S_{21}|}{|S_{12}|}, K = \frac{1 + |\Delta|^2 - |S_{11}|^2 - |S_{22}|^2}{2 |S_{12} S_{21}|}, \Delta = S_{11} S_{22} - S_{21} S_{12}$$

NE021 SERIES

TYPICAL COMMON BASE SCATTERING PARAMETERS (TA = 25°C)

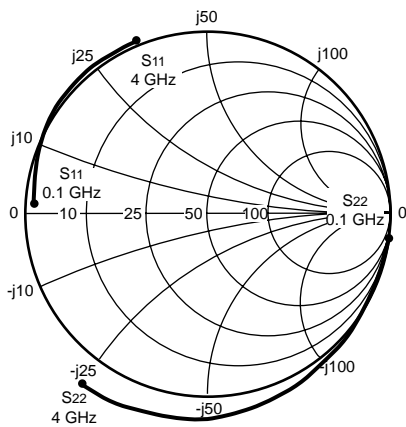

Coordinates in Ohms
Frequency in GHz
(V_{CB} = 10 V, I_c = 20 mA)

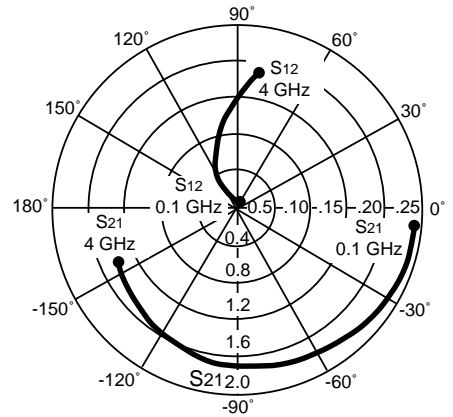

NE02107B

V_{CB} = 10 V, I_c = 5 mA

FREQUENCY (MHz)	S ₁₁		S ₂₁		S ₁₂		S ₂₂		K	MAG ¹ (dB)
	MAG	ANG	MAG	ANG	MAG	ANG	MAG	ANG		
100	.79	175	1.77	-10	.01	106	1.01	-9	-0.477	22.480
500	.79	170	1.78	-24	.01	111	1.02	-22	-0.808	22.504
1000	.79	163	1.72	-44	.01	117	1.05	-40	-1.645	22.355
1500	.83	157	1.71	-64	.03	109	1.09	-58	-1.076	17.559
2000	.83	149	1.57	-87	.06	106	1.09	-75	-0.782	14.177
2500	.87	145	1.53	-99	.08	103	1.08	-81	-0.574	12.816
3000	.87	136	1.40	-122	.11	95	1.11	-96	-0.484	11.047
3500	.87	126	1.21	-140	.13	86	1.10	-111	-0.427	9.688
4000	.86	117	1.12	-164	.17	76	1.08	-125	-0.180	8.188

V_{CB} = 10 V, I_c = 10 mA

100	.88	177	1.84	-6	.01	-31	1.01	-6	0.671	22.648
500	.88	171	1.84	-19	.01	112	1.00	-18	-0.431	22.648
1000	.87	164	1.83	-38	.01	132	1.05	-36	-1.429	22.625
1500	.90	159	1.82	-57	.03	118	1.08	-53	-0.950	17.830
2000	.92	152	1.72	-76	.06	117	1.10	-69	-0.857	14.574
2500	.95	144	1.68	-92	.08	108	1.09	-81	-0.707	13.222
3000	.96	135	1.57	-113	.12	98	1.13	-96	-0.601	11.167
3500	.96	125	1.45	-135	.15	88	1.12	-111	-0.458	9.853
4000	.95	116	1.33	-156	.18	77	1.10	-126	-0.317	8.686

V_{CB} = 10 V, I_c = 20 mA

100	.92	176	1.90	-6	.01	56	1.02	-6	0.315	22.788
500	.93	171	1.89	-19	.01	139	1.01	-18	-0.850	22.765
1000	.92	164	1.89	-37	.01	129	1.05	-36	-1.189	22.765
1500	.96	159	1.88	-55	.03	126	1.09	-53	-0.960	17.970
2000	.97	152	1.81	-75	.06	119	1.10	-69	-0.832	14.795
2500	1.01	142	1.75	-90	.09	110	1.09	-80	-0.727	12.888
3000	1.02	132	1.67	-110	.12	100	1.13	-95	-0.658	11.435
3500	1.03	121	1.55	-132	.15	89	1.13	-110	-0.532	10.142
4000	1.02	112	1.42	-154	.18	79	1.12	-125	-0.388	8.970

V_{CB} = 10 V, I_c = 40 mA

100	.95	176	1.93	-7	.01	-74	1.02	-7	0.239	22.856
600	.94	171	1.91	-20	.01	116	1.01	-19	-0.583	22.810
1000	.94	163	1.91	-38	.01	133	1.05	-36	-1.140	22.810
1500	.98	158	1.90	-57	.03	126	1.09	-53	-0.901	18.016
2000	.99	151	1.83	-77	.06	119	1.10	-69	-0.798	14.843
2500	1.04	141	1.81	-92	.09	111	1.09	-81	-0.727	13.034
3000	1.05	132	1.72	-115	.12	100	1.13	-97	-0.591	11.563
3500	1.05	120	1.58	-136	.15	88	1.13	-113	-0.502	10.226
4000	1.03	111	1.46	-157	.18	77	1.10	-127	-0.341	9.091

Note:

1. Gain Calculations:

$$\text{MAG} = \frac{|S_{21}|}{|S_{12}|} \left(K \pm \sqrt{K^2 - 1} \right). \text{ When } K \leq 1, \text{ MAG is undefined and MSG values are used. } \text{MSG} = \frac{|S_{21}|}{|S_{12}|}, K = \frac{1 + |\Delta|^2 - |S_{11}|^2 - |S_{22}|^2}{2 |S_{12} S_{21}|}, \Delta = S_{11} S_{22} - S_{21} S_{12}$$

TYPICAL COMMON EMITTER SCATTERING PARAMETERS (T_A = 25°C)

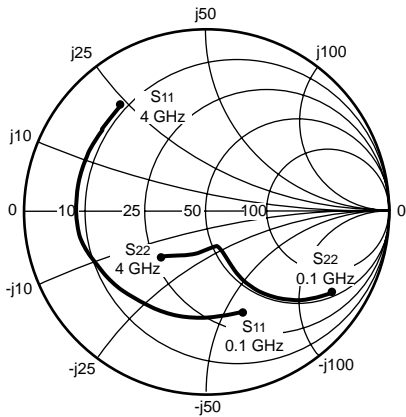

Coordinates in Ohms
Frequency in GHz
(V_{CE} = 10 V, I_c = 20 mA)

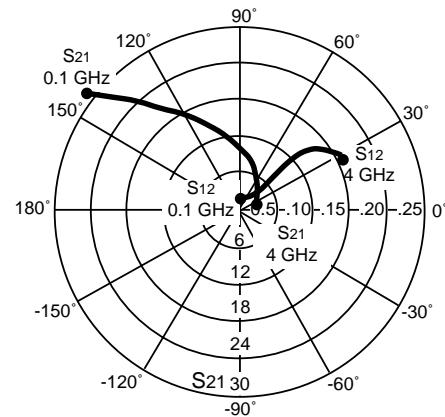

NE02107

V_{CE} = 10 V, I_c = 5 mA

FREQUENCY (MHz)	S ₁₁		S ₂₁		S ₁₂		S ₂₂		K	MAG ¹ (dB)
	MAG	ANG	MAG	ANG	MAG	ANG	MAG	ANG		
100	.82	-36	13.90	157	.01	73	.95	-16	0.022	31.430
500	.70	-125	7.38	107	.07	35	.54	-47	0.345	20.230
1000	.68	-161	4.17	82	.08	25	.39	-59	0.628	17.170
1500	.68	-178	2.87	66	.09	24	.38	-68	0.783	15.036
2000	.68	170	2.18	53	.10	26	.37	-78	0.928	13.385
2500	.67	159	1.73	40	.11	22	.38	-90	1.081	10.227
3000	.67	151	1.49	28	.12	23	.40	-102	1.116	8.867
3500	.68	142	1.27	17	.13	19	.43	-112	1.119	7.802
4000	.68	134	1.16	6	.14	17	.45	-122	1.101	7.249

V_{CE} = 10 V, I_c = 10 mA

100	.69	-54	22.57	150	.01	69	.89	-23	0.085	33.535
500	.67	-145	9.37	100	.05	36	.39	-58	0.489	22.728
1000	.67	-172	5.00	79	.06	36	.27	-70	0.821	19.208
1500	.67	175	3.40	65	.08	37	.26	-77	0.907	16.284
2000	.67	165	2.57	53	.09	40	.25	-87	1.071	12.933
2500	.67	15	2.07	41	.11	35	.28	-97	1.052	11.355
3000	.67	146	1.80	30	.12	34	.31	-108	1.074	10.096
3500	.67	137	1.53	20	.14	30	.34	-116	1.046	9.080
4000	.67	130	1.41	8	.15	23	.36	-125	1.023	8.803

V_{CE} = 10 V, I_c = 20 mA

100	.58	-79	31.63	142	.01	65	.81	-32	0.170	35.001
500	.67	-161	10.57	95	.03	45	.28	-68	0.774	25.470
1000	.67	179	5.47	77	.04	46	.19	-78	1.205	18.622
1500	.67	168	3.70	64	.07	46	.19	-84	1.041	15.998
2000	.67	159	2.78	53	.09	48	.20	-96	1.077	13.207
2500	.67	150	2.26	42	.11	44	.23	-105	1.058	11.658
3000	.68	142	1.96	31	.12	39	.25	-114	1.063	10.601
3500	.67	134	1.68	21	.14	36	.28	-122	1.065	9.238
4000	.68	127	1.53	9	.16	27	.31	-128	0.947	9.806

V_{CE} = 10 V, I_c = 30 mA

100	.55	-96	35.99	137	.01	63	.75	-37	0.236	35.562
500	.67	-167	10.79	93	.02	48	.24	-69	1.157	24.914
1000	.68	176	5.52	75	.04	53	.17	-77	1.192	18.752
1500	.68	166	3.75	63	.07	52	.17	-83	1.028	16.271
2000	.68	158	2.81	52	.09	53	.18	-96	1.065	13.383
2500	.68	148	2.26	41	.11	46	.21	-106	1.057	11.669
3000	.68	141	1.96	30	.13	42	.24	-115	1.008	11.227
3500	.68	133	1.66	20	.14	38	.27	-123	1.066	9.175
4000	.68	126	1.51	9	.16	29	.30	-131	0.984	9.749

Note:

1. Gain Calculations:

$$MAG = \frac{|S_{21}|}{|S_{12}|} \left(K \pm \sqrt{K^2 - 1} \right). \text{ When } K \leq 1, \text{ MAG is undefined and MSG values are used. } MSG = \frac{|S_{21}|}{|S_{12}|}, K = \frac{1 + |\Delta|^2 - |S_{11}|^2 - |S_{22}|^2}{2 |S_{12} S_{21}|}, \Delta = S_{11} S_{22} - S_{21} S_{12}$$

NE021 SERIES

TYPICAL COMMON EMITTER SCATTERING PARAMETERS (TA = 25°C)

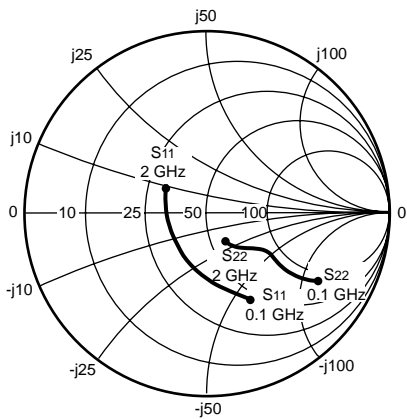

Coordinates in Ohms
Frequency in GHz
(Vce = 10 V, Ic = 20 mA)

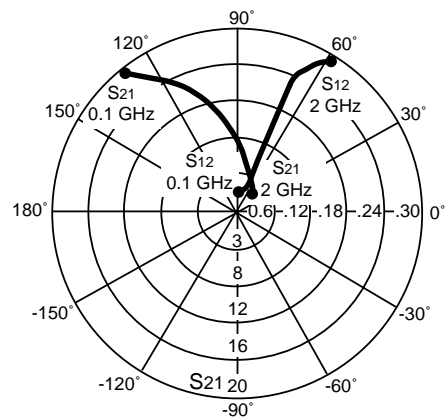

NE02133

VCE = 10 V, Ic = 5 mA

FREQUENCY (MHz)	S11		S21		S12		S22		K	MAG ¹ (dB)
	MAG	ANG	MAG	ANG	MAG	ANG	MAG	ANG		
100	.80	-37	13.53	150	.03	73	.91	-18	0.178	26.542
200	.63	-63	10.48	129	.04	59	.72	-29	0.477	24.183
500	.37	-114	5.56	99	.09	61	.48	-38	0.795	17.908
1000	.27	-158	3.02	76	.15	60	.40	-41	0.988	13.039
1500	.27	172	2.16	63	.21	63	.34	-49	1.039	8.914
2000	.29	151	1.74	49	.27	58	.31	-62	1.031	7.022

VCE = 10 V, Ic = 10 mA

100	.66	-48	19.53	139	.02	79	.81	-27	0.235	29.897
200	.46	-78	13.52	118	.03	58	.58	-35	0.761	26.539
500	.27	-129	6.29	93	.09	67	.38	-36	0.900	18.444
1000	.21	-169	3.31	74	.16	66	.34	-40	0.993	13.157
1500	.23	165	2.35	62	.23	64	.29	-47	1.007	9.593
2000	.26	146	1.87	50	.29	59	.26	-62	1.011	7.438

VCE = 10 V, Ic = 20 mA

100	.51	-61	19.37	129	.02	79	.70	-32	0.497	29.861
200	.33	-91	15.04	109	.03	64	.48	-35	0.909	27.001
500	.21	-143	6.57	89	.08	71	.33	-32	1.010	18.522
1000	.19	-177	3.41	72	.16	69	.32	-37	1.005	12.847
1500	.21	160	2.41	61	.24	67	.26	-45	1.006	9.524
2000	.24	142	1.92	49	.30	59	.23	-59	1.013	7.369

Note:

1. Gain Calculations:

$$MAG = \frac{|S_{21}|}{|S_{12}|} (K \pm \sqrt{K^2 - 1}). \text{ When } K \leq 1, \text{ MAG is undefined and MSG values are used. } MSG = \frac{|S_{21}|}{|S_{12}|}, K = \frac{1 + |\Delta|^2 - |S_{11}|^2 - |S_{22}|^2}{2 |S_{12} S_{21}|}, \Delta = S_{11} S_{22} - S_{21} S_{12}$$

MAG = Maximum Available Gain

MSG = Maximum Stable Gain

TYPICAL COMMON EMITTER SCATTERING PARAMETERS (T_A = 25°C)

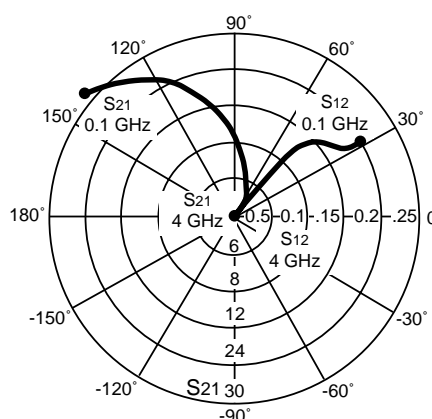
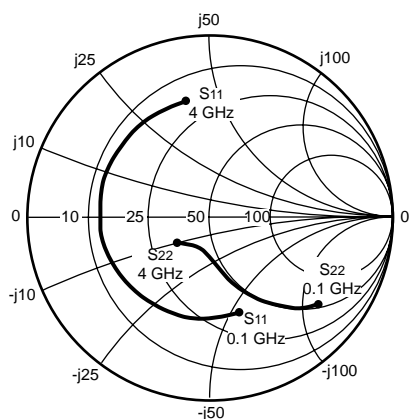

Coordinates in Ohms
Frequency in GHz
(V_{CE} = 10 V, I_C = 20 mA)

NE02135

V_{CE} = 10 V, I_C = 5 mA

FREQUENCY (MHz)	S ₁₁		S ₂₁		S ₁₂		S ₂₂		K	MAG ¹ (dB)
	MAG	ANG	MAG	ANG	MAG	ANG	MAG	ANG		
100	.84	-36	13.82	156	.02	73	.94	-18	0.023	28.395
500	.68	-126	7.18	106	.08	35	.51	-53	0.368	19.530
1000	.66	-163	4.02	81	.09	27	.34	-66	0.664	16.500
1500	.65	178	2.75	64	.10	27	.31	-74	0.890	14.393
2000	.65	163	2.10	52	.12	30	.31	-83	0.960	12.430
2500	.66	151	1.68	39	.13	26	.31	-95	1.075	9.441
3000	.66	141	1.46	27	.14	26	.33	-106	1.125	8.030
3500	.67	129	1.24	17	.16	26	.36	-116	1.099	6.974
4000	.68	121	1.14	5	.17	23	.38	-127	1.069	6.656

V_{CE} = 10 V, I_C = 10 mA

100	0.666	-50	23.536	149	0.004	65	0.854	-28	0.634	37.697
500	0.592	-147	9.285	99	0.033	39	0.363	-72	0.859	24.493
1000	0.604	-179	4.955	77	0.051	39	0.276	-82	1.128	17.700
1500	0.595	163	3.288	63	0.073	39	0.240	-87	1.172	14.054
2000	0.609	152	2.527	46	0.109	36	0.195	-104	1.138	11.397
2500	0.615	139	2.022	39	0.132	41	0.204	-115	1.180	9.287
3000	0.632	126	1.726	28	0.152	38	0.212	-125	1.168	8.071
3500	0.642	114	1.439	12	0.175	27	0.233	-135	1.155	6.763
4000	0.649	104	1.315	5	0.199	27	0.256	-144	1.113	6.156

V_{CE} = 10 V, I_C = 20 mA

100	0.545	-74	32.448	140	0.002	67	0.763	-38	1.982	36.428
500	0.593	-163	10.200	94	0.020	46	0.270	-80	1.428	23.189
1000	0.602	173	5.276	75	0.040	49	0.217	-89	1.445	17.244
1500	0.605	158	3.505	61	0.072	50	0.188	-93	1.210	14.212
2000	0.616	148	2.718	46	0.108	44	0.161	-110	1.115	11.942
2500	0.623	135	2.159	39	0.133	48	0.176	-120	1.142	9.815
3000	0.639	123	1.841	29	0.156	43	0.188	-128	1.110	8.698
3500	0.644	111	1.549	13	0.180	32	0.210	-135	1.094	7.477
4000	0.649	102	1.411	6	0.205	32	0.232	-142	1.060	6.881

V_{CE} = 10 V, I_C = 30 mA

100	.58	-95	35.35	134	.01	59	.72	-40	0.275	35.484
500	.64	-169	10.11	91	.03	50	.22	-82	0.958	25.276
1000	.65	173	5.15	74	.06	55	.14	-97	1.016	18.563
1500	.65	162	3.49	62	.08	63	.14	-103	1.103	14.446
2000	.66	152	2.63	52	.11	54	.15	-112	1.058	12.315
2500	.66	141	2.10	39	.13	46	.17	-122	1.095	10.207
3000	.66	132	1.82	29	.15	42	.19	-129	1.086	9.052
3500	.67	122	1.54	20	.17	38	.22	-137	1.089	7.748
4000	.68	115	1.44	9	.20	31	.24	-146	0.970	8.573

NE021 SERIES

TYPICAL COMMON EMITTER SCATTERING PARAMETERS (T_A = 25°C)

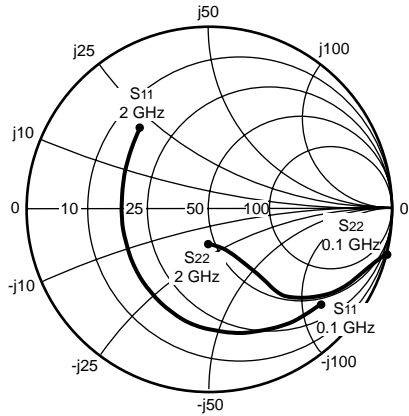

Coordinates in Ohms
Frequency in GHz
(V_{CE} = 10 V, I_C = 5 mA)

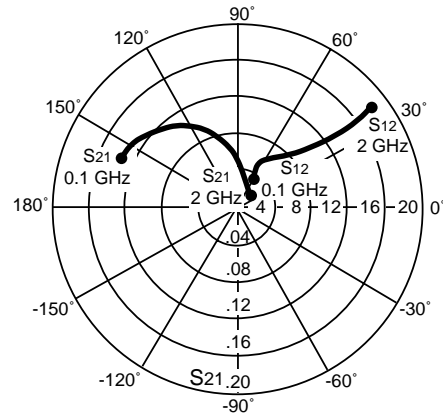

NE02139

V_{CE} = 10 V, I_C = 5 mA

FREQUENCY (MHz)	S ₁₁		S ₂₁		S ₁₂		S ₂₂		K	MAG ¹ (dB)
	MAG	ANG	MAG	ANG	MAG	ANG	MAG	ANG		
100	.78	-39	13.96	156	.027	63	.91	-21	0.167	27.135
200	.71	-74	11.81	131	.058	62	.77	-36	0.329	21.430
400	.57	-114	7.51	107	.081	42	.54	-50	0.563	18.797
600	.50	-143	5.68	93	.093	39	.42	-56	0.738	16.985
800	.49	-164	4.16	72	.104	37	.35	-59	0.860	15.398
1000	.49	-180	3.50	81	.117	37	.30	-63	0.938	14.105
1200	.51	168	2.83	55	.129	37	.27	-66	0.977	12.978
1400	.52	160	2.59	63	.144	36	.25	-73	1.017	11.247
1600	.53	150	2.19	49	.155	38	.22	-79	1.046	9.850
1800	.53	142	2.09	42	.173	36	.21	-88	1.059	8.908
2000	.56	135	1.79	36	.181	36	.19	-98	1.096	8.065

V_{CE} = 10 V, I_C = 10 mA

100	.63	-58	20.38	145	.025	58	.81	-31	0.267	29.113
200	.56	-98	15.27	119	.039	60	.61	-45	0.534	23.790
400	.47	-139	8.90	98	.062	44	.39	-57	0.773	20.566
600	.45	-164	6.48	87	.073	50	.30	-60	0.912	18.320
800	.45	180	4.66	76	.091	49	.25	-63	0.984	16.309
1000	.47	168	3.89	69	.109	50	.21	-68	1.023	13.826
1200	.48	157	3.13	61	.126	48	.18	-71	1.038	12.288
1400	.50	152	2.86	54	.143	44	.17	-80	1.044	11.116
1600	.51	143	2.41	48	.160	46	.14	-88	1.045	10.104
1800	.52	136	2.30	42	.181	42	.14	-99	1.048	9.263
2000	.54	130	1.97	36	.191	41	.12	-113	1.084	8.371

V_{CE} = 10 V, I_C = 20 mA

100	.53	-82	25.86	136	.021	35	.72	-41	0.435	30.904
200	.47	-121	17.23	110	.033	61	.48	-51	0.711	25.017
400	.43	-157	9.44	92	.051	50	.30	-58	0.905	21.298
600	.44	-177	6.74	83	.069	57	.23	-60	0.971	18.616
800	.45	170	4.82	74	.090	55	.20	-61	1.024	15.561
1000	.46	161	4.01	67	.107	54	.16	-66	1.044	13.619
1200	.48	152	3.23	39	.127	54	.14	-71	1.028	12.483
1400	.50	147	2.95	53	.149	50	.13	-80	1.035	11.252
1600	.51	139	2.48	47	.164	50	.10	-91	1.038	10.206
1800	.52	133	2.36	41	.187	45	.10	-104	1.030	9.506
2000	.55	127	2.02	36	.197	44	.09	-121	1.055	8.680

Note:

1. Gain Calculations:

$$\text{MAG} = \frac{|S_{21}|}{|S_{12}|} \left(K \pm \sqrt{K^2 - 1} \right). \text{ When } K \leq 1, \text{ MAG is undefined and MSG values are used. } \text{MSG} = \frac{|S_{21}|}{|S_{12}|}, K = \frac{1 + |\Delta|^2 - |S_{11}|^2 - |S_{22}|^2}{2 |S_{12} S_{21}|}, \Delta = S_{11} S_{22} - S_{21} S_{12}$$

MAG = Maximum Available Gain, MSG = Maximum Stable Gain

OUTLINE DIMENSIONS (Units in mm)

NE02100 (CHIP)

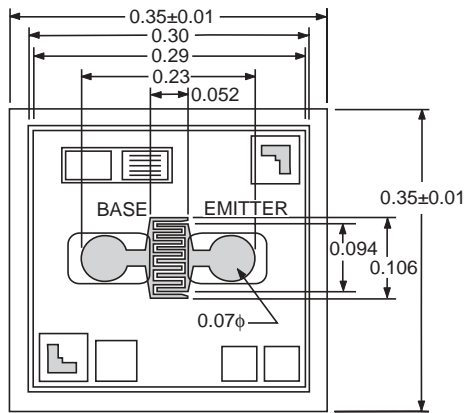

PACKAGE OUTLINE 07

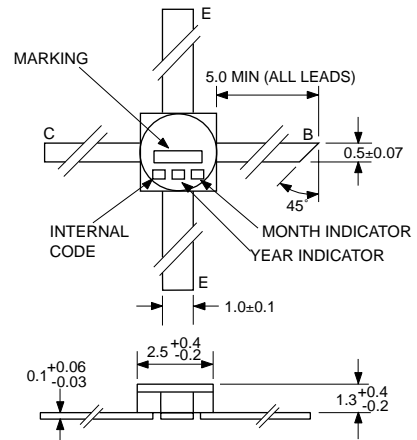

*07B has emitter and base reversed..

PACKAGE OUTLINE 33

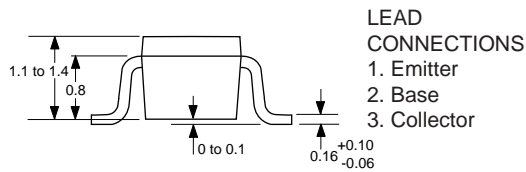
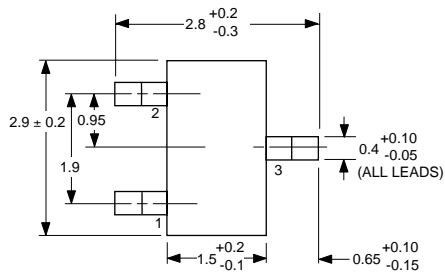

- LEAD CONNECTIONS**
1. Emitter
 2. Base
 3. Collector

**PACKAGE OUTLINE 33
RECOMMENDED P.C.B. LAYOUT**

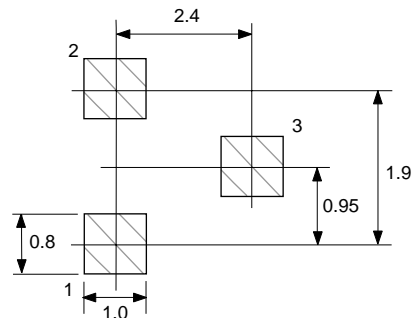

**PACKAGE OUTLINE 35
(MICRO-X)**

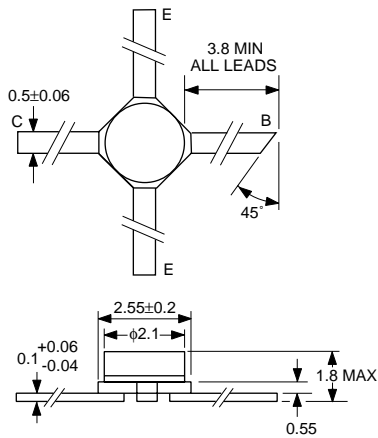

**PACKAGE OUTLINE 39
(SOT-23)**

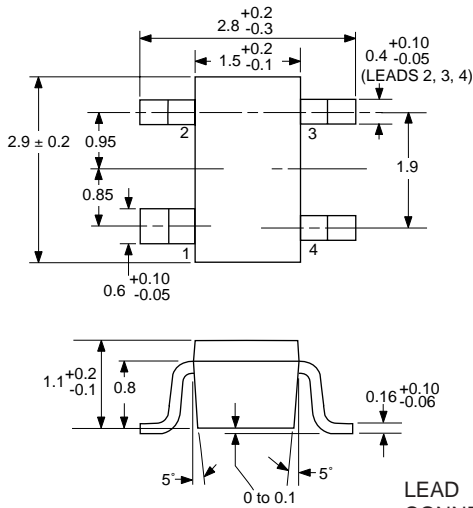

- LEAD CONNECTIONS**
- 1. Collector
 - 2. Emitter
 - 3. Base
 - 4. Emitter

**PACKAGE OUTLINE 39
RECOMMENDED P.C.B. LAYOUT**

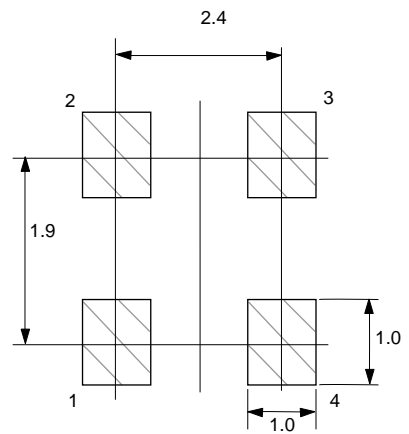

ORDERING INFORMATION

PART NUMBER	QUANTITY	PACKAGING
NE02100	100	Waffle Pack
NE02107/NE02107B	1	Hard Pack
NE02133-T1B	3000	Tape & Reel
NE02135	1	ESD Bag
NE02139-T1	3000	Tape & Reel

Life Support Applications

These NEC products are not intended for use in life support devices, appliances, or systems where the malfunction of these products can reasonably be expected to result in personal injury. The customers of CEL using or selling these products for use in such applications do so at their own risk and agree to fully indemnify CEL for all damages resulting from such improper use or sale.

CEL California Eastern Laboratories, Your source for NEC RF, Microwave, Optoelectronic, and Fiber Optic Semiconductor Devices.
4590 Patrick Henry Drive • Santa Clara, CA 95054-1817 • (408) 988-3500 • FAX (408) 988-0279 • www.cel.com

DATA SUBJECT TO CHANGE WITHOUT NOTICE

08/05/2002