

8 PIN DIP 400 V BREAKDOWN VOLTAGE 2-CH OPTICAL COUPLED MOSFET

**PS7141-2A
PS7141L-2A**

FEATURES

- **2 CHANNEL TYPE:**
(1a + 1a output)
- **DESIGNED FOR AC/DC SWITCHING LINE CHANGER**
- **SMALL PACKAGE:**
8 pin DIP
- **LOW OFFSET VOLTAGE**
- **LOW LED OPERATING CURRENT:**
($I_F = 2 \text{ mA}$)
- **SURFACE MOUNT AVAILABLE:**
PS7141-2A

DESCRIPTION

PS7141-2A and PS7141L-2A are solid state relays containing GaAs LEDs on the light emitting side (input side) and MOSFETs on the output side. They are suitable for analog signal control because of their low offset and high linearity.

APPLICATIONS

- EXCHANGE EQUIPMENT
- MEASUREMENT EQUIPMENT
- FA/OA EQUIPMENT

ELECTRICAL CHARACTERISTICS ($T_A = 25 \text{ }^\circ\text{C}$)

PART NUMBER				PS7141-2A, PS7141L-2A		
SYMBOLS		PARAMETERS	UNITS	MIN	TYP	MAX
Diode	V_F	Forward Voltage, $I_F = 10 \text{ mA}$	V		1.2	1.4
	I_R	Reverse Current, $V_R = 5 \text{ V}$	μA			5.0
MOS FET	I_{LOFF}	Off-State Leakage Current, $V_D = 400 \text{ V}$	μA		0.03	1.0
	C_{OUT}	Output Capacitance, $V_D = 0 \text{ V}$, $f = 1 \text{ MHz}$	pF/ch		65	
Coupled	I_{Fon}	LED On-state Current, $I_L = 150 \text{ mA}$	mA			2.0
	R_{on1}	On-State Resistance, $I_F = 10 \text{ mA}$, $I_L = 10 \text{ mA}$	Ω		20	30
	R_{on2}			$I_F = 10 \text{ mA}$, $I_L = 150 \text{ mA}$, $t \leq 10 \text{ ms}$	16	25
	t_{ON}	Turn-on Time ¹	ms		0.35	1.0
	t_{OFF}	Turn-off Time ¹			0.06	0.2
	R_{I-O}	Isolation Resistance, $V_{I-O} = 1.0 \text{ kV}$	Ω	10^9		
	C_{I-O}	Isolation Capacitance, $V = 0 \text{ V}$, $f = 1 \text{ MHz}$	pF/ch		1.1	

Note:

1. Test Circuit for Switching Time:

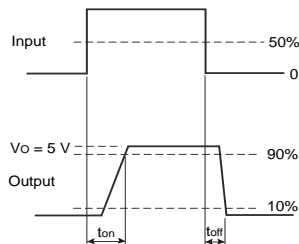
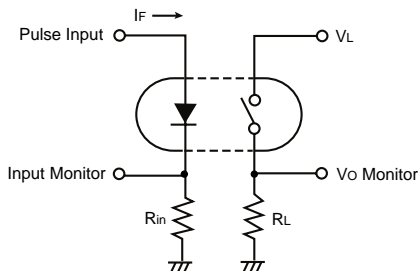

PS7141-2A, PS7141L-2A

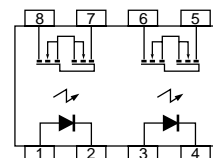

PS7141-2A, PS7141L-2A

ABSOLUTE MAXIMUM RATINGS¹ (T_A = 25°C)

SYMBOLS	PARAMETERS	UNITS	RATINGS
Diode			
I _F	Forward Current (DC)	mA	50
V _R	Reverse Voltage	V	5.0
P _D	Power Dissipation	mW/ch	50
I _{FP}	Peak Forward Current ²	A	1
MOSFET			
V _L	Break Down Voltage	V	400
I _L	Continuous Load Current	mA	150
I _{LP}	Pulse Load Current ³ AC/DC Connection	mA	300
P _D	Power Dissipation	mW/ch	375
Coupled			
BV	Isolation Voltage ⁴	Vr.m.s.	1500
P _T	Total Power Dissipation	mW	850
T _A	Operating Ambient Temp.	°C	-40 to +80
T _{STG}	Storage Temperature	°C	-40 to +100

Notes:

1. Operation in excess of any one of these parameters may result in permanent damage.
2. PW = 100 μs, Duty Cycle = 1 %.
3. PW = 100 ms, 1 shot.
4. AC voltage for 1 minute at T_A = 25 °C, RH = 60 % between input and output.

OUTLINE DIMENSIONS (Units in mm)

PS7141-2A

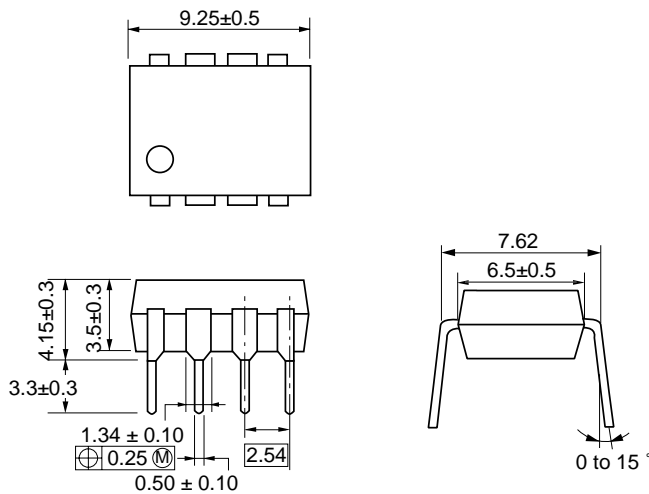

PS7141L-2A

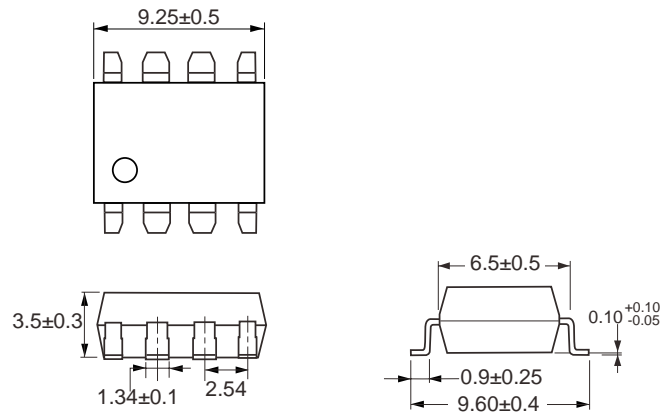

PIN CONNECTION (Top View)

PS7141-2A, PS7141L-2A

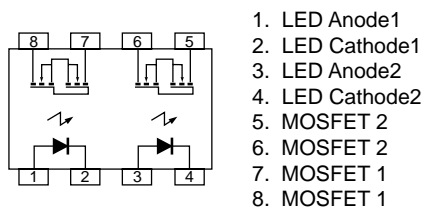

RECOMMENDED OPERATING CONDITIONS (T_A = 25°C)

PART NUMBER		PS7141-2A, PS7141L-2A			
SYMBOLS	PARAMETERS	UNITS	MIN	TYP	MAX
I _F	LED Operating Current	mA	2	10	20
V _F	LED Off Voltage	V	0		0.5

ORDERING INFORMATION

PART NUMBER	PACKAGE	PACKING STYLE
PS7141-2A	8 PIN DIP	Magazine case 50 pcs
PS7141L-2A		
PS7141L-2A-E3		Embossed Tape 1000 pcs/reel
PS7141L-2A-E3		

TYPICAL PERFORMANCE CURVES (TA = 25 °C)

MAXIMUM FORWARD CURRENT vs. AMBIENT TEMPERATURE

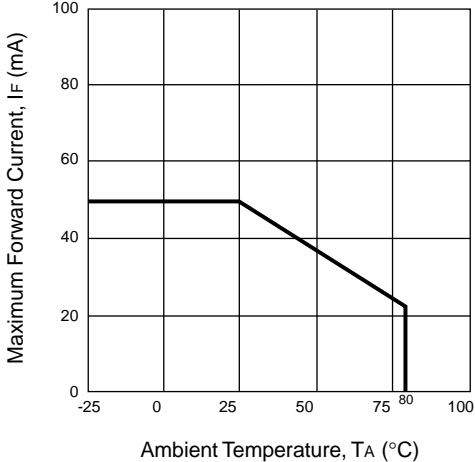

MAXIMUM LOAD CURRENT vs. AMBIENT TEMPERATURE

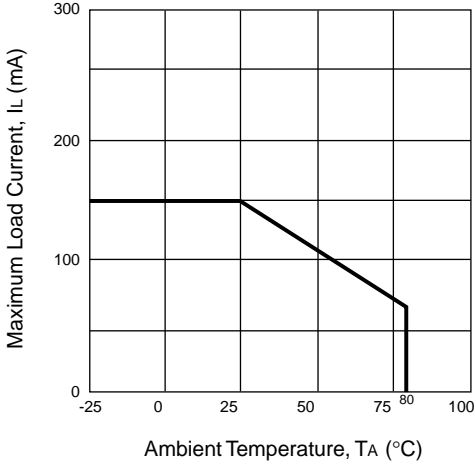

FORWARD VOLTAGE vs. AMBIENT TEMPERATURE

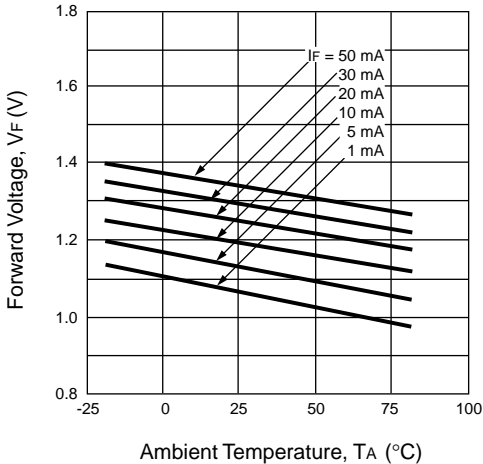

OUTPUT CAPACITANCE vs. SUPPLY VOLTAGE

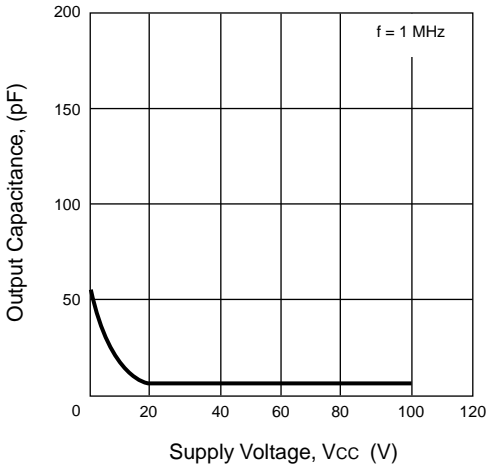

OFF-STATE LEAKAGE CURRENT vs. SUPPLY VOLTAGE

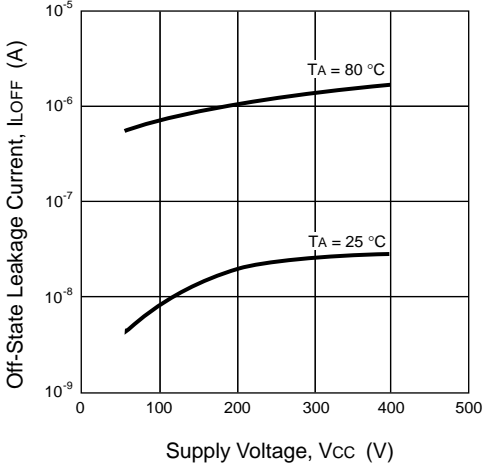

LOAD CURRENT vs. LOAD VOLTAGE

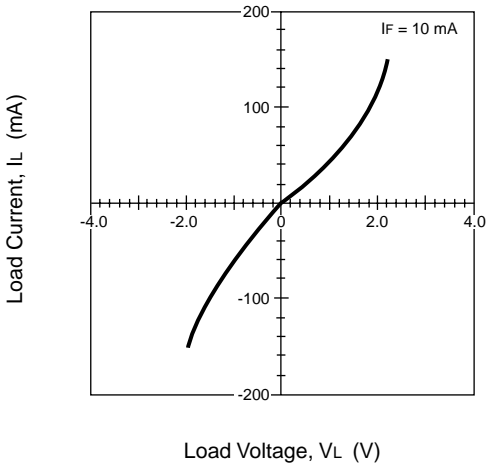

TYPICAL PERFORMANCE CURVES (TA = 25 °C)

NORMALIZED ON-STATE RESISTANCE vs. AMBIENT TEMPERATURE

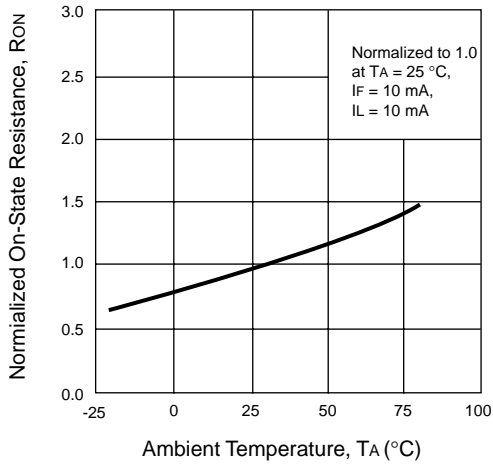

ON-STATE DISTRIBUTION

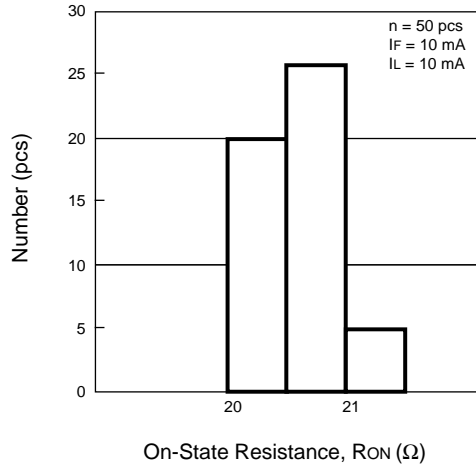

TURN-ON TIME vs. FORWARD CURRENT

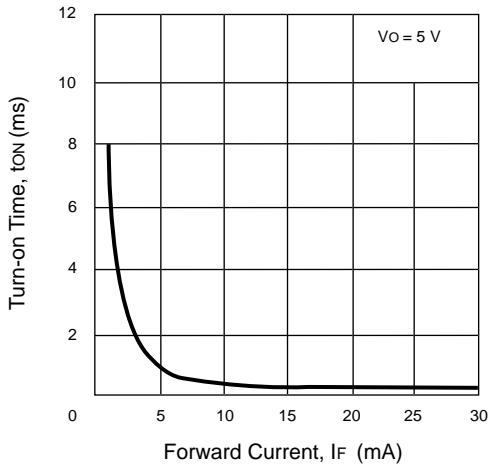

TURN-OFF TIME vs. FORWARD CURRENT

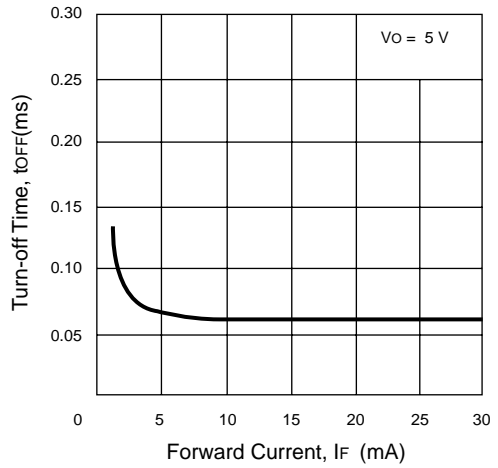

TURN-ON TIME DISTRIBUTION

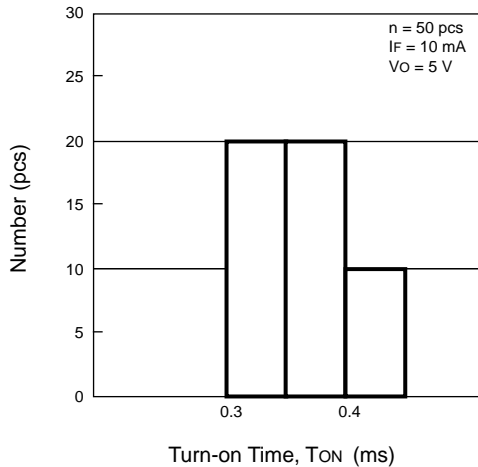

TURN-OFF TIME DISTRIBUTION

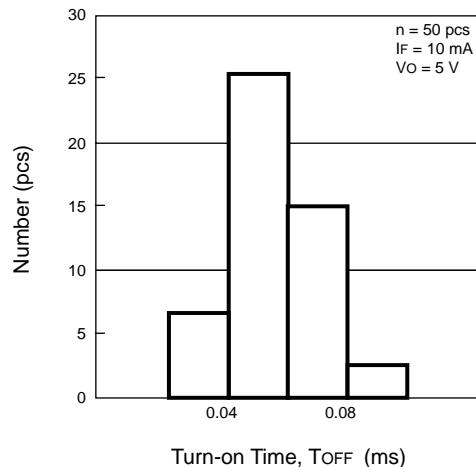

TYPICAL PERFORMANCE CURVES ($T_A = 25\text{ }^\circ\text{C}$)

NORMALIZED TURN-ON TIME vs. AMBIENT TEMPERATURE

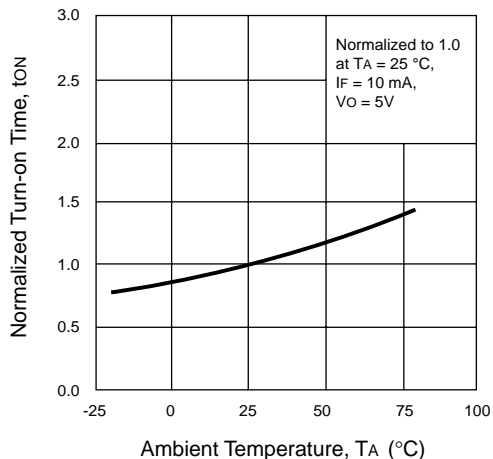

NORMALIZED TURN-OFF TIME vs. AMBIENT TEMPERATURE

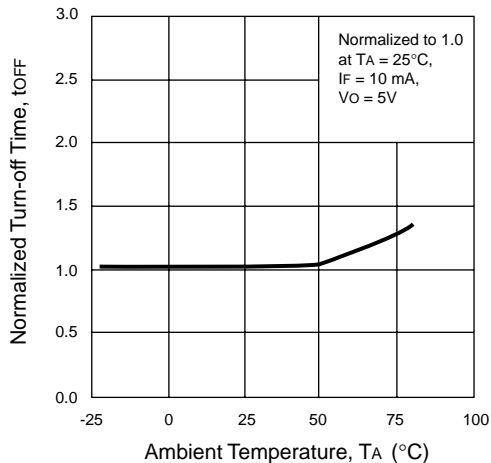

TAPING SPECIFICATIONS (Units in mm)

OUTLINE AND DIMENSIONS (TAPE)

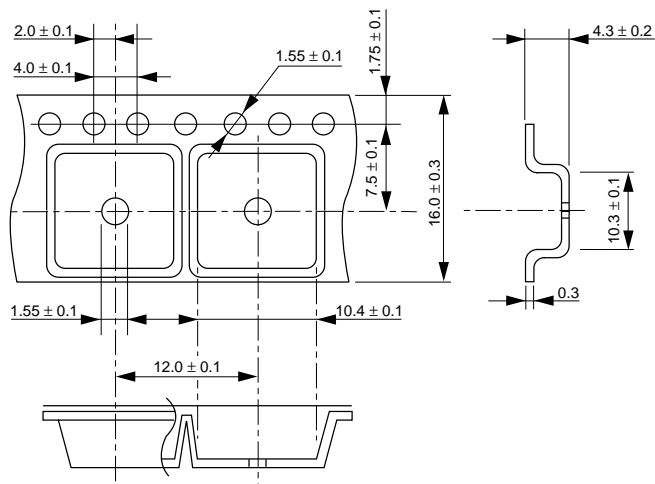

OUTLINE AND DIMENSIONS (REEL)

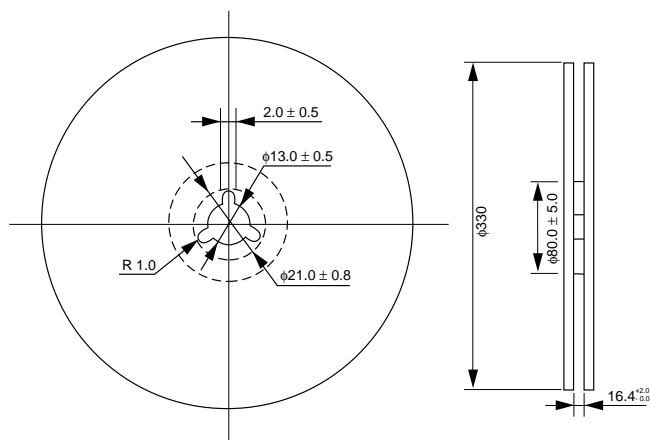

Notes:
1. Packaging : 1000 pcs/reel

TAPING DIRECTION

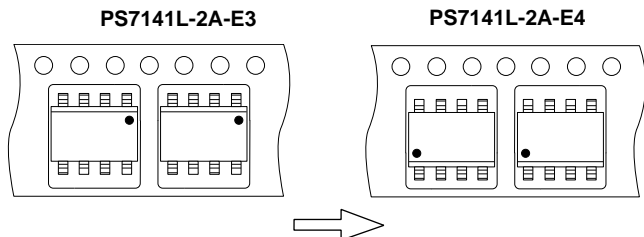

RECOMMENDED SOLDERING CONDITIONS

(1) Infrared reflow soldering

- Peak reflow temperature 235 °C or below (package surface temperature)
- Time of temperature higher than 210 °C 30 seconds or less
- Number of reflows Two
- Flux Rosin flux containing small amount of chlorine
(The flux with a maximum chlorine content of 0.2 Wt % is recommended.)

Recommended Temperature Profile of Infrared Reflow

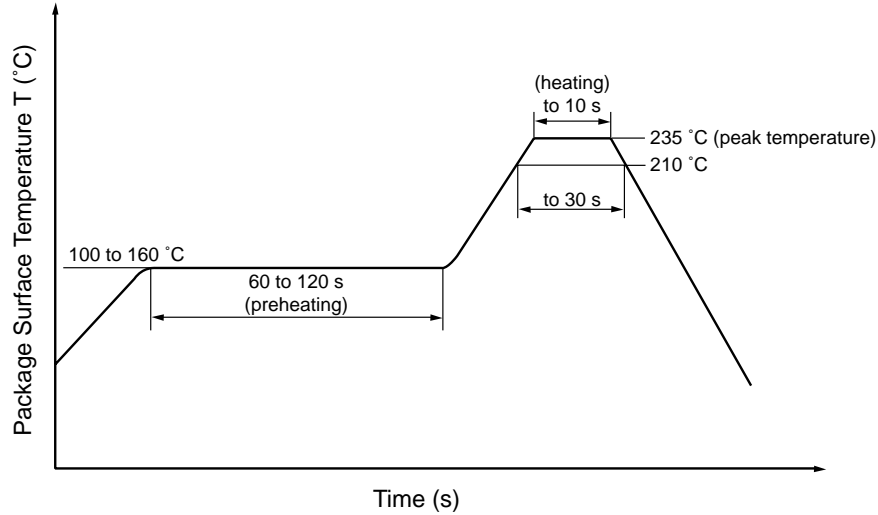

(2) Dip soldering

- Temperature 260 °C or below (molten solder temperature)
- Time 10 seconds or less
- Number of times One
- Flux Rosin flux containing small amount of chlorine
(The flux with a maximum chlorine content of 0.2 Wt % is recommended.)

(3) Cautions

- Fluxes
Avoid removing the residual flux with freon-based cleaning solvent.

Life Support Applications

These NEC products are not intended for use in life support devices, appliances, or systems where the malfunction of these products can reasonably be expected to result in personal injury. The customers of CEL using or selling these products for use in such applications do so at their own risk and agree to fully indemnify CEL for all damages resulting from such improper use or sale.

EXCLUSIVE NORTH AMERICAN AGENT FOR NEC RF, MICROWAVE & OPTOELECTRONIC SEMICONDUCTORS