

# BIPOLAR ANALOG INTEGRATED CIRCUIT

# $\mu$ PC317

### 3-TERMINAL POSITIVE ADJUSTABLE REGULATOR

#### DESCRIPTION

The  $\mu$ PC317 is an adjustable 3-terminal positive voltage regulator, which has 1.5 A capable for the output current. The output voltage can be set any value between 1.3 V and 30 V by two external resistors.

#### FEATURES

- Output current excess of 1.5 A
- On-chip some protection circuit (over current protection, SOA protection and thermal shut down).

#### PIN CONFIGURATION (Marking Side)

3-pin plastic SIP (MP-45G)

$\mu$ PC317HF

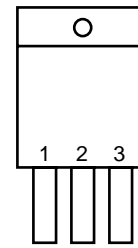

1 : ADJ  
2 : OUTPUT  
3 : INPUT

#### ORDERING INFORMATION

Part Number	Package
$\mu$ PC317HF	3-pin plastic SIP (MP-45G) (isolated TO-220)

#### EQUIVALENT CIRCUIT

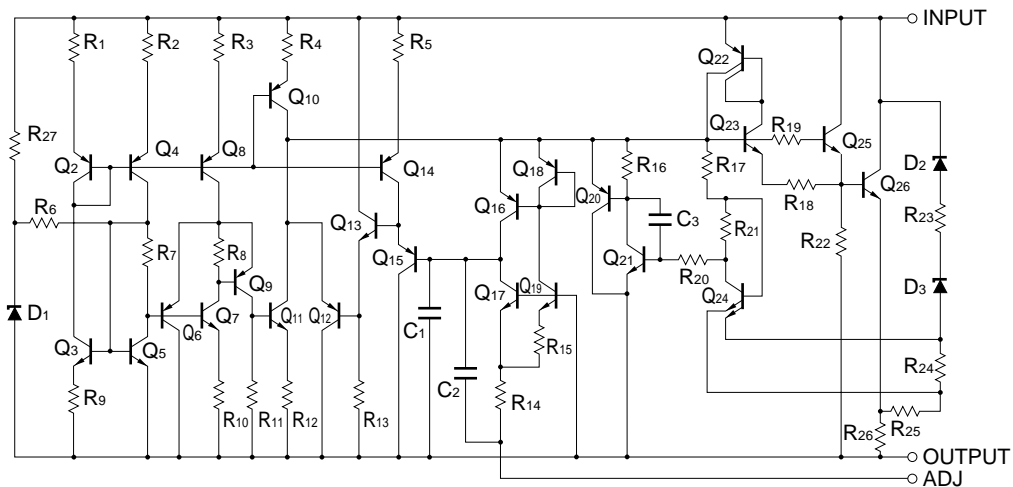

The information in this document is subject to change without notice. Before using this document, please confirm that this is the latest version.  
Not all devices/types available in every country. Please check with local NEC representative for availability and additional information.

**ABSOLUTE MAXIMUM RATINGS ( $T_A = 25^\circ\text{C}$ , unless otherwise specified.)**

Parameter	Symbol	Rating	Unit
Input-Output Voltage Differential	$V_{IN} - V_O$	-0.3 to +40	V
Total Power Dissipation ( $T_C = 25^\circ\text{C}$ )	$P_T$	15 <sup>Note</sup>	W
Operating Ambient Temperature	$T_A$	-20 to +80	$^\circ\text{C}$
Operating Junction Temperature	$T_J$	-20 to +150	$^\circ\text{C}$
Storage Temperature	$T_{stg}$	-65 to +150	$^\circ\text{C}$
Thermal Resistance (junction to case)	$R_{th(J-C)}$	5	$^\circ\text{C/W}$
Thermal Resistance (junction to ambient)	$R_{th(J-A)}$	65	$^\circ\text{C/W}$

**Note** Internally limited.

When operating junction temperature rise up to  $150^\circ\text{C}$  ( $\leq 200^\circ\text{C}$ ), the internal circuit shutdown output voltage.

**Caution** Product quality may suffer if the absolute maximum rating is exceeded even momentarily for any parameter. That is, the absolute maximum ratings are rated values at which the product is on the verge of suffering physical damage, and therefore the product must be used under conditions that ensure that the absolute maximum ratings are not exceeded.

**RECOMMENDED OPERATING CONDITIONS**

Parameter	Symbol	MIN.	TYP.	MAX.	Unit
Input-Output Voltage Differential	$V_{IN} - V_O$	3		38.7	V
Input Voltage	$V_{IN}$	4.3		40	V
Output Voltage	$V_O$	1.3		30	V
Output Current	$I_O$	0.01		1.5	A
Operating Junction Temperature	$T_J$	-20		+125	$^\circ\text{C}$

**Caution** The recommended operating range may be exceeded without causing any problems provided that the absolute maximum ratings are not exceeded. However, if the device is operated in a way that exceeds the recommended operating conditions, the margin between the actual conditions of use and the absolute maximum ratings is small, and therefore thorough evaluation is necessary. The recommended operating conditions do not imply that the device can be used with all values at their maximum values.

TYPICAL CONNECTION

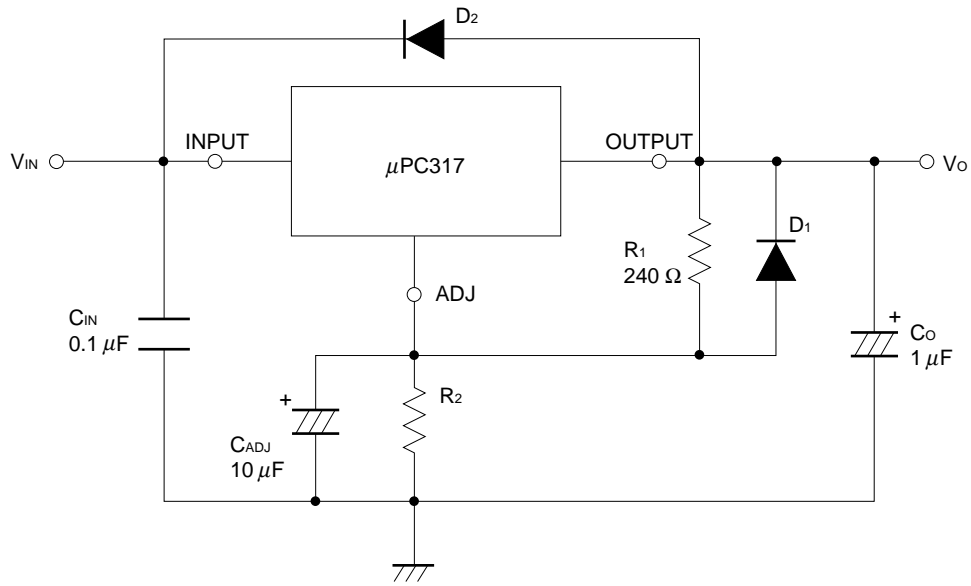

**Remark** R<sub>1</sub>, R<sub>2</sub> : Resistor to set the output voltage.

$$V_o = \left(1 + \frac{R_2}{R_1}\right) \cdot V_{REF} + I_{ADJ} \cdot R_2 \approx \left(1 + \frac{R_2}{R_1}\right) \cdot V_{REF}$$

V <sub>o</sub> (V)	R <sub>2</sub> (Ω : TYP.)
1.25	0
2.5	240
5.0	720
12	2064
24	4368
30	5520

C<sub>IN</sub> : Need to stop the oscillation for the long input wiring length.

C<sub>O</sub> : Need to stop the oscillation for the long output wiring length.

Improve the transient stability of the output voltage when the load current is suddenly changed.

C<sub>ADJ</sub> : Improve the ripple rejection and the oscillate rejection.

D<sub>1</sub> : Protect against C<sub>ADJ</sub> from output short.

D<sub>2</sub> : Need for V<sub>IN</sub> < V<sub>O</sub>.

**ELECTRICAL CHARACTERISTICS**

( $V_{IN} - V_O = 5\text{ V}$ ,  $I_O = 0.5\text{ A}$ ,  $0^\circ\text{C} \leq T_J \leq +125^\circ\text{C}$ , unless otherwise specified.)

Parameter	Symbol	Conditions	MIN.	TYP.	MAX.	Unit	
Line Regulation	REG <sub>IN</sub>	$T_A = 25^\circ\text{C}$ , $3\text{ V} \leq (V_{IN} - V_O) \leq 40\text{ V}$ , $I_O = 0.1\text{ A}$ <sup>Note</sup>		0.01	0.04	%/V	
		$3\text{ V} \leq (V_{IN} - V_O) \leq 40\text{ V}$ , $I_O = 0.1\text{ A}$ <sup>Note</sup>		0.02	0.07	%/V	
Load Regulation	REG <sub>L</sub>	$T_J = 25^\circ\text{C}$	$V_O \leq 5\text{ V}$		5	25	mV
		$10\text{ mA} \leq I_O \leq 1.5\text{ A}$ <sup>Note</sup>	$V_O \geq 5\text{ V}$		0.1	0.5	%
		$10\text{ mA} \leq I_O \leq 1.5\text{ A}$ <sup>Note</sup>	$V_O \leq 5\text{ V}$		20	70	mV
			$V_O \geq 5\text{ V}$		0.3	1.5	%
Thermal Regulation	REG <sub>TH</sub>	$T_A = 25^\circ\text{C}$ , $0.2\text{ ms} \leq t \leq 20\text{ ms}$		0.01	0.07	%/W	
ADJ pin Output Current	I <sub>ADJ</sub>			50	100	μA	
I <sub>ADJ</sub> Change	ΔI <sub>ADJ</sub>	$10\text{ mA} \leq I_O \leq 1.5\text{ A}$ , $P_T \leq 15\text{ W}$		0.4	5	μA	
Reference Voltage	V <sub>REF</sub>	$10\text{ mA} \leq I_O \leq 1.5\text{ A}$ , $P_T \leq 15\text{ W}$	1.20	1.25	1.30	V	
Temperature Stability of V <sub>REF</sub>	ΔV <sub>REF</sub> /ΔT			0.7		%	
Minimum Load Current	I <sub>OMIN.</sub>	$V_{IN} - V_O = 40\text{ V}$		4.7	10	mA	
Peak Output Current	I <sub>Opeak</sub>	$5\text{ V} \leq (V_{IN} - V_O) \leq 15\text{ V}$	1.5	2.2	2.9	A	
		$V_{IN} - V_O = 40\text{ V}$	0.15	0.8		A	
Output Noise Voltage (RMS)	V <sub>n</sub>	$T_A = 25^\circ\text{C}$ , $10\text{ Hz} \leq f \leq 10\text{ kHz}$		0.001		%	
Ripple Rejection	R • R	$T_A = 25^\circ\text{C}$ , $\Delta V_{IN} = 1\text{ V}_{r.m.s}$ $f = 120\text{ Hz}$ , $V_O = 10\text{ V}$	C <sub>ADJ</sub> = 0		48		dB
			C <sub>ADJ</sub> = 10 μF	56	65		dB

**Note** Measured at constant junction temperature, using pulse testing with a low duty cycle.  
PW = 10 ms, Duty Cycle ≤ 2 %

**TYPICAL CHARACTERISTICS (T<sub>A</sub> = 25°C, unless otherwise specified. Reference Values.)**

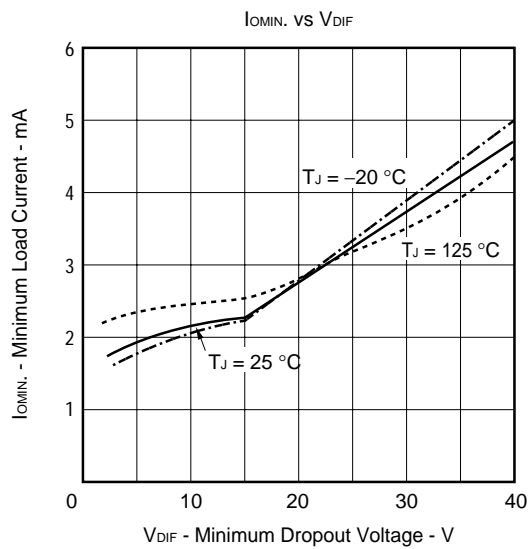
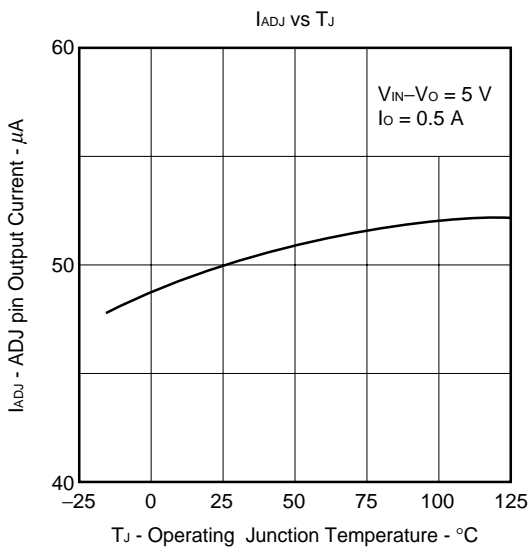
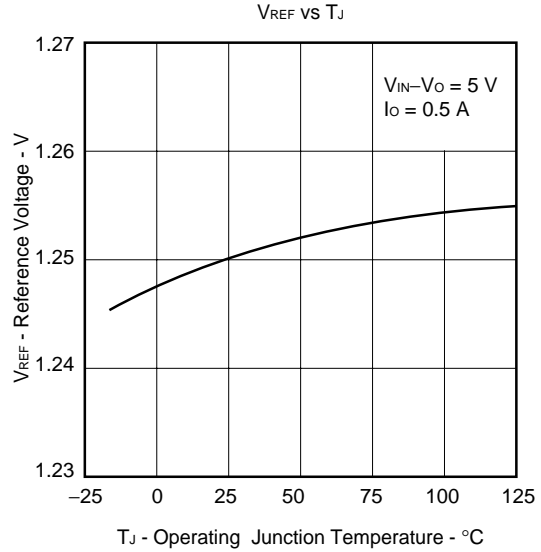
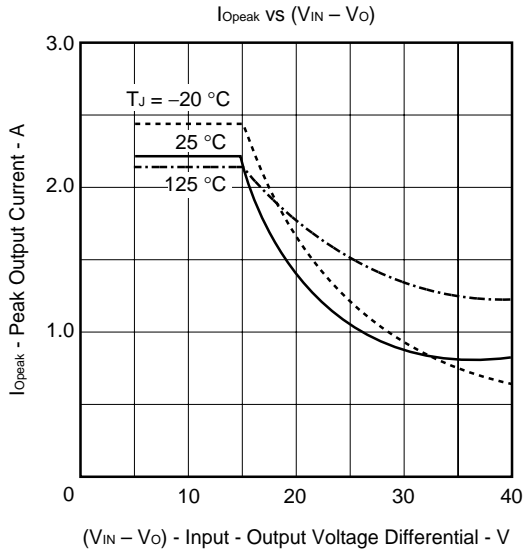
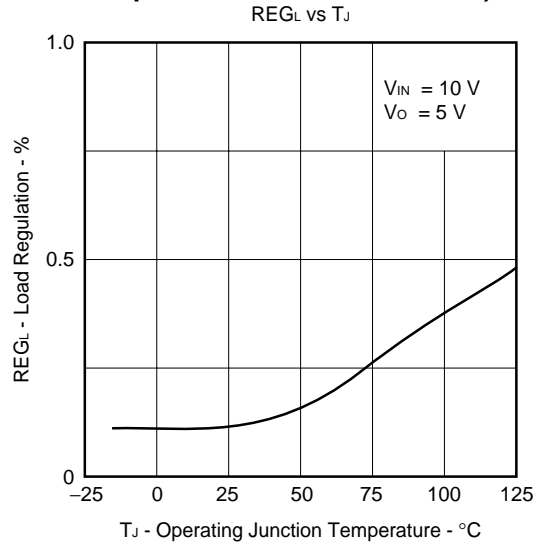
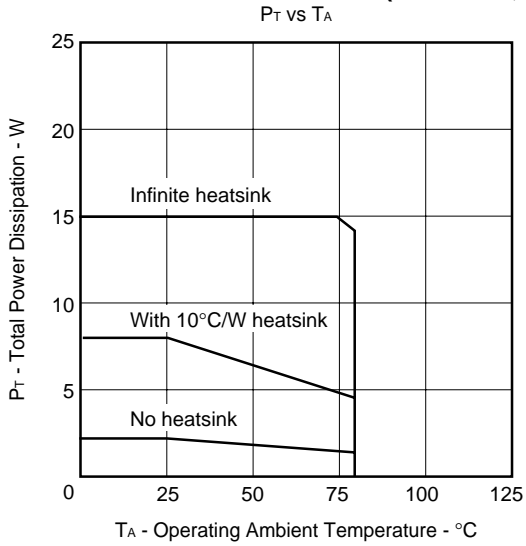

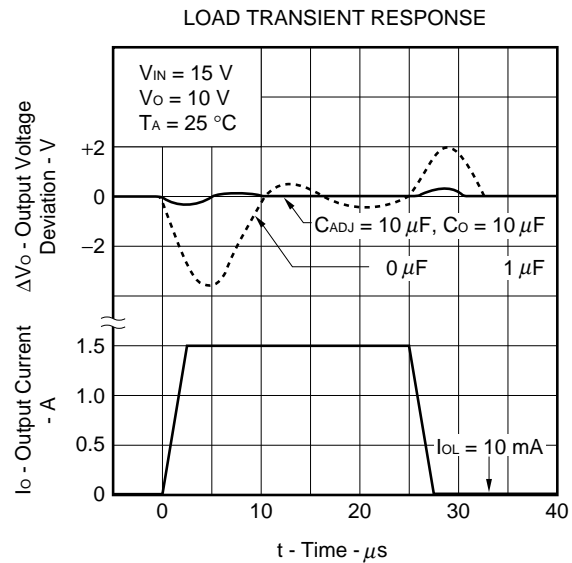
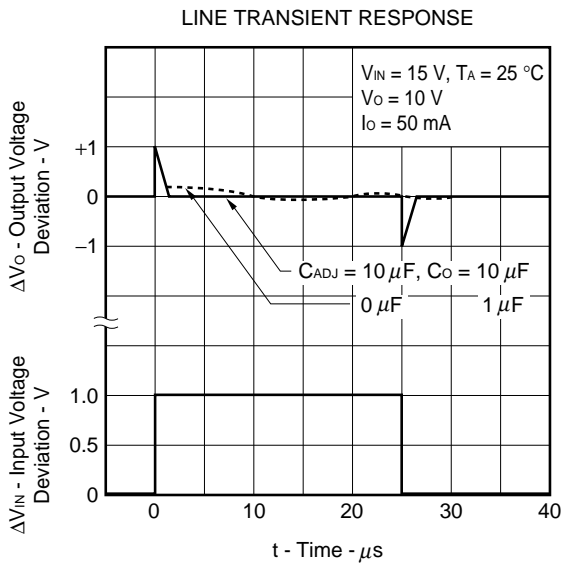
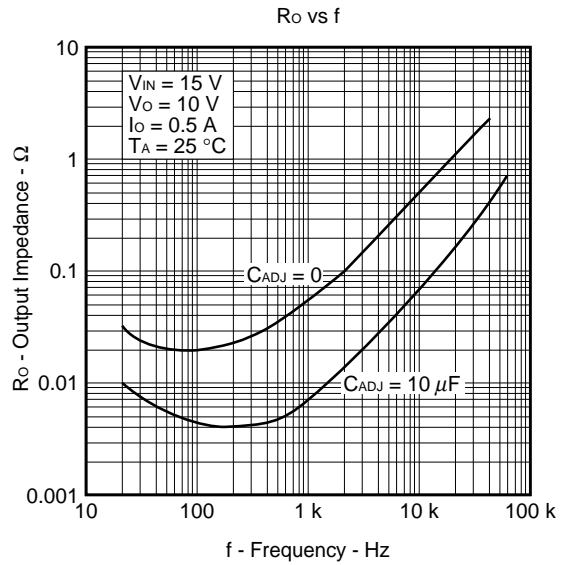
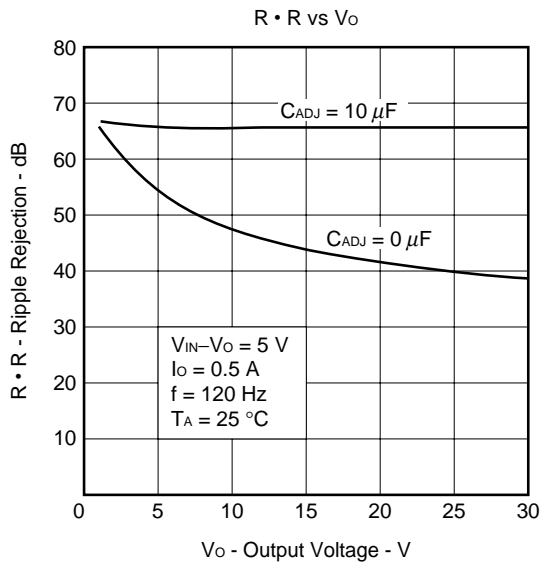
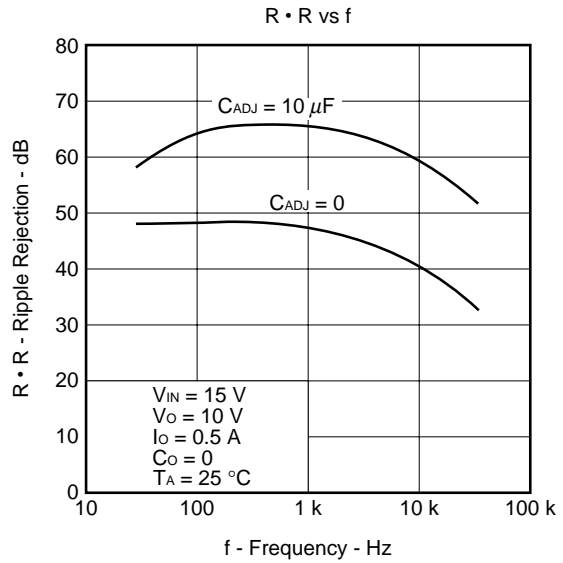
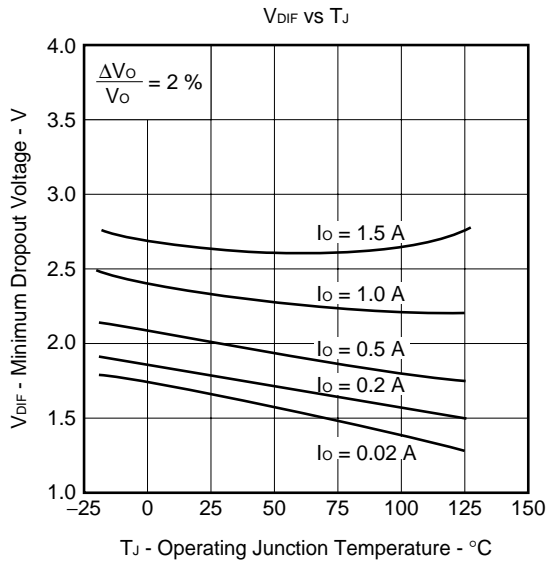

PACKAGE DRAWING

3PIN PLASTIC SIP (MP-45G)

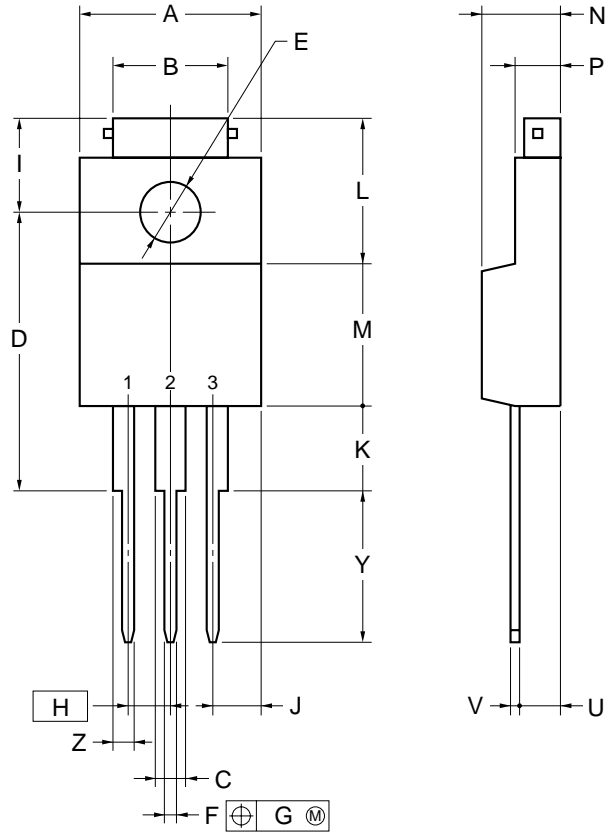

**NOTE**

Each lead centerline is located within 0.25 mm of its true position (T.P.) at maximum material condition.

ITEM	MILLIMETERS
A	10.0±0.2
B	7.0±0.2
C	1.50±0.2
D	17.0±0.3
E	φ3.3±0.2
F	0.75±0.10
G	0.25
H	2.54 (T.P.)
I	5.0±0.3
J	2.46±0.2
K	5.0±0.2
L	8.5±0.2
M	8.5±0.2
N	4.5±0.2
P	2.8±0.2
U	2.4±0.5
V	0.65±0.10
Y	8.9±0.7
Z	1.30±0.2

P3HF-254B-4

**RECOMMENDED SOLDERING CONDITIONS**

When soldering these products, it is highly recommended to observe the conditions as shown below. If other soldering processes are used, or if the soldering is performed under different conditions, please make sure to consult with our sales offices.

For more details, refer to our document "**SEMICONDUCTOR DEVICE MOUNTING TECHNOLOGY MANUAL (C10535E)**".

**Type of Through-hole Devices**

μPC317HF: 3-pin plastic SIP (MP-45G)(isolated TO-220)

Process	Conditions
Wave soldering (only to leads)	Solder temperature: 260°C or below, Flow time: 10 seconds or less.
Partial heating method	Pin temperature: 300°C or below, Heat time: 3 seconds or less (per each lead).

**Caution** For through-hole device, the wave soldering process must be applied only to leads, and make sure that the package body does not get jet soldered.

**REFERENCE DOCUMENTS**

QUALITY GRADES ON NEC SEMICONDUCTOR DEVICES	C11531E
SEMICONDUCTOR DEVICE MOUNTING THCHNOLOGY MANUAL	C10535E
SEMICONDUCTORS SELECTION GUIDE – Products and Packages – (CD-ROM)	X13769X
SEMICONDUCTORS SELECTION GUIDE	X10679E
NEC SEMICONDUCTOR DEVICE RELIABILITY/QUALITY CONTROL SYSTEM	IEI-1212
-THREE TERMINAL REGULATOR	



[MEMO]

[MEMO]

[MEMO]

[MEMO]

- **The information in this document is subject to change without notice. Before using this document, please confirm that this is the latest version.**
- No part of this document may be copied or reproduced in any form or by any means without the prior written consent of NEC Corporation. NEC Corporation assumes no responsibility for any errors which may appear in this document.
- NEC Corporation does not assume any liability for infringement of patents, copyrights or other intellectual property rights of third parties by or arising from use of a device described herein or any other liability arising from use of such device. No license, either express, implied or otherwise, is granted under any patents, copyrights or other intellectual property rights of NEC Corporation or others.
- Descriptions of circuits, software, and other related information in this document are provided for illustrative purposes in semiconductor product operation and application examples. The incorporation of these circuits, software, and information in the design of the customer's equipment shall be done under the full responsibility of the customer. NEC Corporation assumes no responsibility for any losses incurred by the customer or third parties arising from the use of these circuits, software, and information.
- While NEC Corporation has been making continuous effort to enhance the reliability of its semiconductor devices, the possibility of defects cannot be eliminated entirely. To minimize risks of damage or injury to persons or property arising from a defect in an NEC semiconductor device, customers must incorporate sufficient safety measures in its design, such as redundancy, fire-containment, and anti-failure features.
- NEC devices are classified into the following three quality grades:  
"Standard", "Special", and "Specific". The Specific quality grade applies only to devices developed based on a customer designated "quality assurance program" for a specific application. The recommended applications of a device depend on its quality grade, as indicated below. Customers must check the quality grade of each device before using it in a particular application.
  - Standard: Computers, office equipment, communications equipment, test and measurement equipment, audio and visual equipment, home electronic appliances, machine tools, personal electronic equipment and industrial robots
  - Special: Transportation equipment (automobiles, trains, ships, etc.), traffic control systems, anti-disaster systems, anti-crime systems, safety equipment and medical equipment (not specifically designed for life support)
  - Specific: Aircraft, aerospace equipment, submersible repeaters, nuclear reactor control systems, life support systems or medical equipment for life support, etc.

The quality grade of NEC devices is "Standard" unless otherwise specified in NEC's Data Sheets or Data Books. If customers intend to use NEC devices for applications other than those specified for Standard quality grade, they should contact an NEC sales representative in advance.