

**EPITAXIAL SILICON POWER TRANSISTORS**

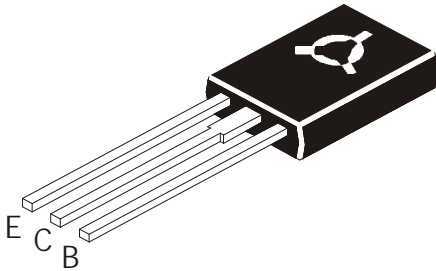

<b>BD175</b>	<b>BD176</b>
<b>BD177</b>	<b>BD178</b>
<b>BD179</b>	<b>BD180</b>
<b>NPN</b>	<b>PNP</b>

**TO126**  
**Plastic Package**

**Intended for use in Medium Power Linear Switching Applications**

**ABSOLUTE MAXIMUM RATINGS**

DESCRIPTION	SYMBOL	BD175 BD176	BD177 BD178	BD179 BD180	UNIT
Collector -Emitter Voltage	$V_{CEO}$	45	60	80	V
Collector -Base Voltage	$V_{CBO}$	45	60	80	V
Emitter Base Voltage	$V_{EBO}$	5.0			V
Collector Current	$I_C$	3.0			A
Collector Peak Current	$I_{CM}$	7.0			A
Power Dissipation @ $T_a=25^\circ\text{C}$ Derate above $25^\circ\text{C}$	$P_D$	1.25			W
		10			mW/ $^\circ\text{C}$
Power Dissipation @ $T_c=25^\circ\text{C}$	$P_D$	30			W
Operating and Storage Junction Temperature Range	$T_j, T_{stg}$	- 65 to +150			$^\circ\text{C}$

**THERMAL CHARACTERISTICS**

Junction to Ambient in free air	$R_{th(j-a)}$	100	$^\circ\text{C/W}$
Junction to Case	$R_{th(j-c)}$	4.16	$^\circ\text{C/W}$

**ELECTRICAL CHARACTERISTICS ( $T_c=25^\circ\text{C}$  unless specified otherwise)**

DESCRIPTION	SYMBOL	TEST CONDITION		MIN	MAX	UNIT	
Collector Cut off Current	$I_{CBO}$	$V_{CB}=45\text{V}, I_E=0$	<b>BD175/76</b>		100	$\mu\text{A}$	
		$V_{CB}=60\text{V}, I_E=0$	<b>BD177/78</b>		100	$\mu\text{A}$	
		$V_{CB}=80\text{V}, I_E=0$	<b>BD179/80</b>		100	$\mu\text{A}$	
Emitter Cut off Current	$I_{EBO}$	$V_{EB}=5\text{V}, I_C=0$			1.0	mA	
Collector Emitter Sustaining Voltage	$*V_{CEO(sus)}$	$I_C=100\text{mA}, I_B=0$	<b>BD175/76</b>	45		V	
			<b>BD177/78</b>	60		V	
			<b>BD179/80</b>	80		V	
Collector Emitter Saturation Voltage	$*V_{CE(sat)}$	$I_C=1\text{A}, I_B=0.1\text{A}$			0.8	V	
Base Emitter on Voltage	$*V_{BE(on)}$	$I_C=1\text{A}, V_{CE}=2\text{V}$			1.3	V	
DC Current Gain	$*h_{FE}$	$I_C=150\text{mA}, V_{CE}=2\text{V}$ $I_C=1\text{A}, V_{CE}=2\text{V}$		40			
				15			
		$*h_{FE}$ Group	$I_C=150\text{mA}, V_{CE}=2\text{V}$	- 6	40	100	
				- 10	63	160	
		<b>Only BD175/76/79</b>	- 16	100	250		
Transition Frequency	$f_T$	$I_C=250\text{mA}, V_{CE}=10\text{V}$		3.0		MHz	

\*Pulse test:- Pulse width=300ms, Duty cycle=1.5%

BD175	BD176
BD177	BD178
BD179	BD180
NPN	PNP

**TO126  
Plastic Package**

**TO-126 (SOT-32) Plastic Package**

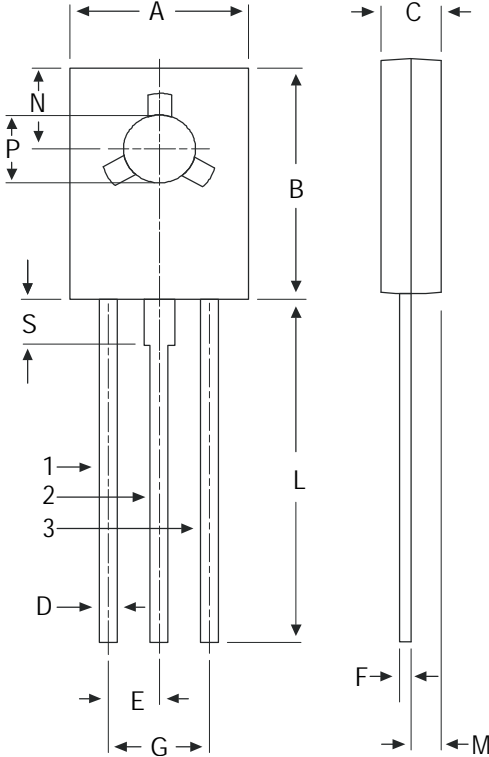

DIM	MIN	MAX
A	7.4	7.8
B	10.5	10.8
C	2.4	2.7
D	0.7	0.9
E	2.25 TYP.	
F	0.49	0.75
G	4.5 TYP.	
L	15.7 TYP.	
M	1.27 TYP.	
N	3.75 TYP.	
P	3.0	3.2
S	2.5 TYP.	

All dimensions in mm.

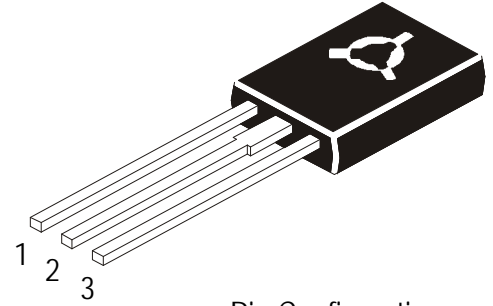

**Pin Configuration**

1. Emitter
2. Collector
3. Base

**TO-126 TUBE PACKING**

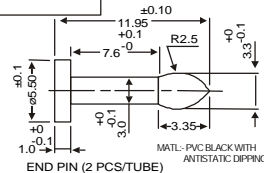
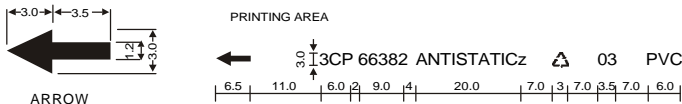
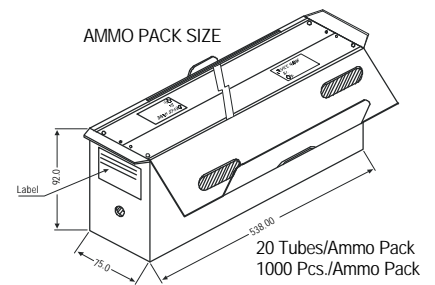
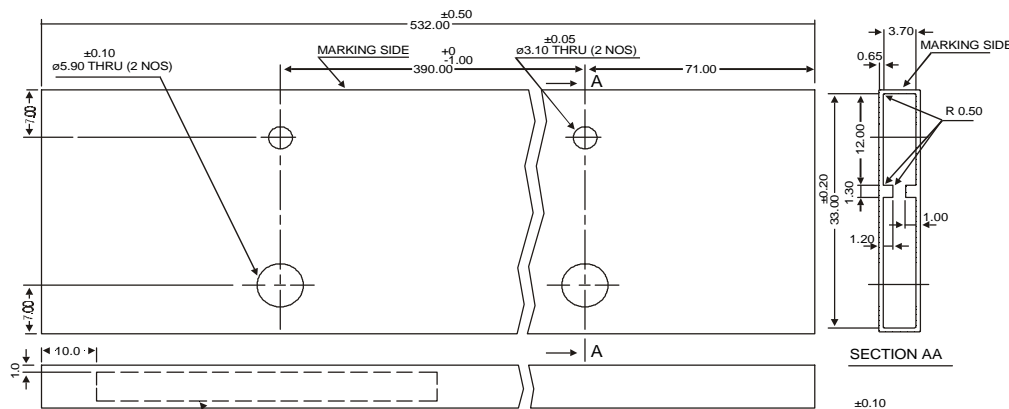

- Notes:**
1. All print in black.
  2. All text in Helvetia medium font.

GENERAL TOLERANCE						
0 mm	0.01 mm	30.01 mm	120.01 mm	ABOVE 315 mm	ANGULAR	
5 mm	30 mm	120 mm	315 mm	315 mm		
±0.1	±0.2	±0.3	±0.5	±0.8	±0° 30"	

All dimensions in mm

**Packing Detail**

PACKAGE	STANDARD PACK		INNER CARTON BOX		OUTER CARTON BOX		
	Details	Net Weight/Qty	Size	Qty	Size	Qty	Gr Wt
TO-126 Bulk	500 pcs/polybag	340 gm/500 pcs	3" x 7.5" x 7.5"	2K	17" x 15" x 13.5"	32K	31 kgs
TO-126 Tube	50 pcs/tube	73 gm/50 pcs	3" x 3.7" x 21.5"	1K	19" x 19" x 19"	10K	15 kgs

## Notes

<b>BD175</b>	<b>BD176</b>
<b>BD177</b>	<b>BD178</b>
<b>BD179</b>	<b>BD180</b>
<b>NPN</b>	<b>PNP</b>

**TO126**  
**Plastic Package**

### Disclaimer

The product information and the selection guides facilitate selection of the CDIL's Discrete Semiconductor Device(s) best suited for application in your product(s) as per your requirement. It is recommended that you completely review our Data Sheet(s) so as to confirm that the Device(s) meet functionality parameters for your application. The information furnished in the Data Sheet and on the CDIL Web Site/CD are believed to be accurate and reliable. CDIL however, does not assume responsibility for inaccuracies or incomplete information. Furthermore, CDIL does not assume liability whatsoever, arising out of the application or use of any CDIL product; neither does it convey any license under its patent rights nor rights of others. These products are not designed for use in life saving/support appliances or systems. CDIL customers selling these products (either as individual Discrete Semiconductor Devices or incorporated in their end products), in any life saving/support appliances or systems or applications do so at their own risk and CDIL will not be responsible for any damages resulting from such sale(s).

CDIL strives for continuous improvement and reserves the right to change the specifications of its products without prior notice.



CDIL is a registered Trademark of  
Continental Device India Limited

C-120 Naraina Industrial Area, New Delhi 110 028, India.

Telephone + 91-11-2579 6150 Fax + 91-11-2579 9569, 2579 5290

e-mail sales@cdil.com www.cdil.com www.cdilsemi.com