

SILICON PLANAR ZENER DIODES

**CMBZ5229B to CMBZ5261B
4.3V to 47V**

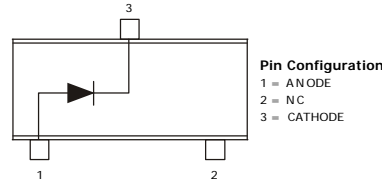
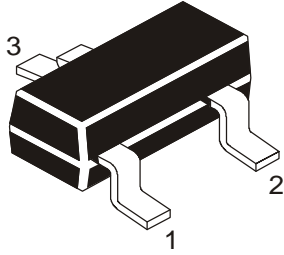

**SOT-23
Formed SMD Package**

Low voltage general purpose voltage regulator diodes.

ABSOLUTE MAXIMUM RATINGS (T_a=25°C)

DESCRIPTION	SYMBOL	VALUE	UNIT
Working Voltage Range	V _Z	4.3 to 47	V
Working Voltage Tolerance		± 5	%
Power Dissipation upto T _a =25°C	*P _{tot}	300	mW
Derate Above 25°C		2.4	mW/°C
Thermal Resistance Junction to Ambient	R _{th(j-a)}	417	°C/mW
Power Dissipation upto T _a =25°C	**P _{tot}	225	mW
Derate Above 25°C		1.8	mW/°C
Thermal Resistance Junction to Ambient	R _{th(j-a)}	556	°C/mW
Junction Temperature	T _j	150	°C
Storage Temperature	T _{stg}	- 55 to +150	°C

* Device mounted on a ceramic alumina of 8mm x 10mm x 0.7 mm

** Device mounted on an FR5 printed - circuit board

Forward Voltage at I_F=10mA VF < 0.9 V

ELECTRICAL CHARACTERISTICS (T_a=25°C unless specified otherwise)

Device	Zener Voltage V _Z (± 5%) Note1 Nominal	Test Current I _{ZT} mA	Z _{ZK} I _Z =0.25mA	Z _{ZT} I _Z =I _{ZT} at 10% Mod	I _R at V _R T _a = 25°C		Marking
			Max W	Max W	Max mA	V	
CMBZ5229B	4.3	20	2000	22	5.0	1.0	8D
CMBZ5230B	4.7	20	1900	19	5.0	2.0	8E
CMBZ5231B	5.1	20	1600	17	5.0	2.0	8F
CMBZ5232B	5.6	20	1600	11	5.0	3.0	8G
CMBZ5233B	6.0	20	1600	7	5.0	3.5	8H
CMBZ5234B	6.2	20	1000	7	5.0	4.0	8J
CMBZ5235B	6.8	20	750	5	3.0	5.0	8K
CMBZ5236B	7.5	20	500	6	3.0	6.0	8L
CMBZ5237B	8.2	20	500	8	3.0	6.5	8M
CMBZ5238B	8.7	20	600	8	3.0	6.5	8N
CMBZ5239B	9.1	20	600	10	3.0	7.0	8P
CMBZ5240B	10	20	600	17	3.0	8.0	8Q
CMBZ5241B	11	20	600	22	2.0	8.4	8R
CMBZ5242B	12	20	600	30	1.0	9.1	8S
CMBZ5243B	13	9.5	600	13	0.5	9.9	8T
CMBZ5244B	14	9.0	600	15	0.1	10	8U

Note1: Pulse Test 20ms ≤ tp ≤ 50ms

SILICON PLANAR ZENER DIODES

**CMBZ5229B to CMBZ5261B
4.3V to 47V**

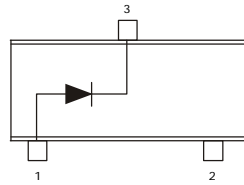
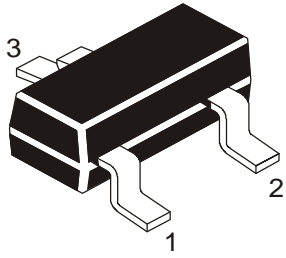

Pin Configuration
 1 = ANODE
 2 = NC
 3 = CATHODE

**SOT-23
Formed SMD Package**

Forward Voltage at $I_F=10\text{mA}$

$V_F < 0.9\text{ V}$

ELECTRICAL CHARACTERISTICS ($T_a=25^\circ\text{C}$ unless specified otherwise)

Device	Zener Voltage $V_Z (\pm 5\%)$ (Note1) Nominal	Test Current I_{ZT} mA	Z_{ZK} $I_Z=0.25\text{mA}$ Max W	Z_{ZT} $I_Z=I_{ZT}$ @ 10% Mod Max W	I_R $T_a=25^\circ\text{C}$ at V_R		Marking
					Max mA	V	
CMBZ5245B	15	8.5	600	16	0.1	11	8V
CMBZ5246B	16	7.8	600	17	0.1	12	8W
CMBZ5247B	17	7.4	600	19	0.1	13	8X
CMBZ5248B	18	7.0	600	21	0.1	14	8Y
CMBZ5249B	19	6.6	600	23	0.1	14	8Z
CMBZ5250B	20	6.2	600	25	0.1	15	81A
CMBZ5251B	22	5.6	600	29	0.1	17	81B
CMBZ5252B	24	5.2	600	33	0.1	18	81C
CMBZ5253B	25	5.0	600	35	0.1	19	81D
CMBZ5254B	27	4.6	600	41	0.1	21	81E
CMBZ5255B	28	4.5	600	44	0.1	21	81F
CMBZ5256B	30	4.2	600	49	0.1	23	81G
CMBZ5257B	33	3.8	700	58	0.1	25	81H
CMBZ5258B	36	3.4	700	70	0.1	27	81J
CMBZ5259B	39	3.2	800	80	0.1	30	81K
CMBZ5260B	43	3.0	800	93	0.1	33	81L
CMBZ5261B	47	2.7	1000	105	0.1	36	81M

Note1: Pulse Test $20\text{ms} \leq t_p \leq 50\text{ms}$

SOT-23 Formed SMD Package

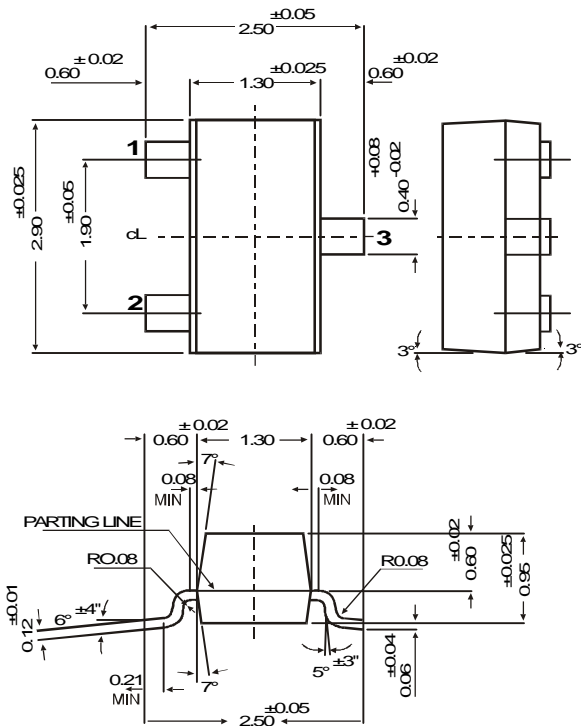

SOT-23 Package Reel Information
Reel specification for W" Packing (13" reel)

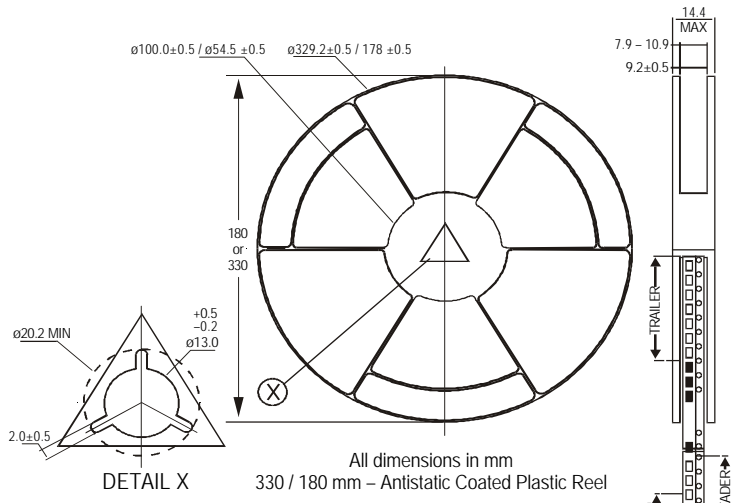

NOTES:

- | | 8mm Tape
Size of Reel | 8mm Tape
Size of Reel |
|----------------|----------------------------|--------------------------|
| No. of Devices | 330 mm (13")
10,000 Pcs | 180 mm (7")
3,000 Pcs |
- The bandolier of 330 mm reel contains at least 10,000 devices.
 - The bandolier of 180 mm reel contains at least 3,000 devices.
 - No more than 0.5% missing devices / reel. 50 empty compartments for 330 mm reel. 15 empty compartments for 180 mm reel.
 - Three consecutive empty places might be found provided this gap is followed by 6 consecutive devices.
 - The carrier tape (leader) starts with at least 75 empty positions (equivalent to 330 mm). In order to fix the carrier tape a self adhesive tape of 20 to 50 mm is applied. At the end of the bandolier at least 40 empty positions (equivalent to 160 mm) are there.

Tape Specification for SOT-23 Surface Mount Device

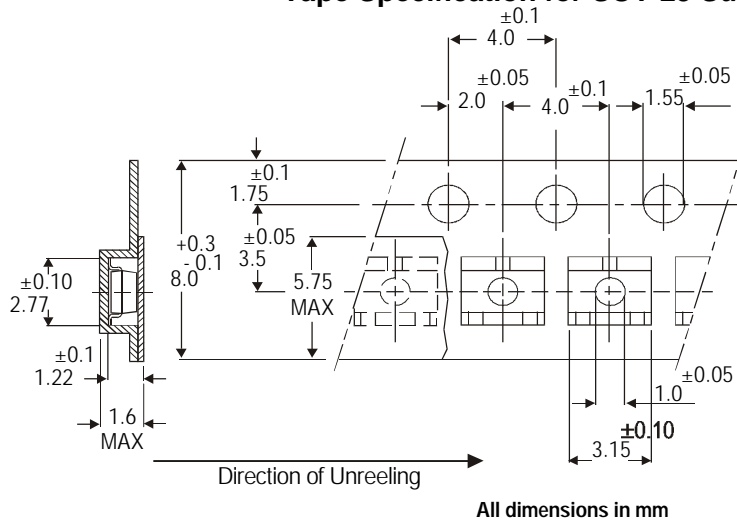

Packing Detail

PACKAGE	STANDARD PACK		INNER CARTON BOX		OUTER CARTON BOX		
	Details	Net Weight/Qty	Size	Qty	Size	Qty	Gr Wt
SOT-23 T&R	3K/feel	136 gm/3K pcs	3" x 7.5" x 7.5"	12 K	17" x 15" x 13.5"	192 K	12 kgs
	10K/feel	415 gm/10K pcs	9" x 9" x 9"	51 K	19" x 19" x 19"	408 K	28 kgs
			13" x 13" x 0.5"	10 K	17" x 15" x 13.5"	300 K	16 kgs

Disclaimer

The product information and the selection guides facilitate selection of the CDIL's Discrete Semiconductor Device(s) best suited for application in your product(s) as per your requirement. It is recommended that you completely review our Data Sheet(s) so as to confirm that the Device(s) meet functionality parameters for your application. The information furnished in the Data Sheet and on the CDIL Web Site/CD are believed to be accurate and reliable. CDIL however, does not assume responsibility for inaccuracies or incomplete information. Furthermore, CDIL does not assume liability whatsoever, arising out of the application or use of any CDIL product; neither does it convey any license under its patent rights nor rights of others. These products are not designed for use in life saving/support appliances or systems. CDIL customers selling these products (either as individual Discrete Semiconductor Devices or incorporated in their end products), in any life saving/support appliances or systems or applications do so at their own risk and CDIL will not be responsible for any damages resulting from such sale(s).

CDIL strives for continuous improvement and reserves the right to change the specifications of its products without prior notice.



CDIL is a registered Trademark of
Continental Device India Limited

C-120 Naraina Industrial Area, New Delhi 110 028, India.
Telephone + 91-11-2579 6150, 5141 1112 Fax + 91-11-2579 5290, 5141 1119
email@cdil.com www.cdilsemi.com