

2N6648, 2N6649, 2N6650

File Number 1013

10-Ampere P-N-P Darlington Power Transistors

40-60-80 Volts, 70 Watts
Gain of 1000 at 5 A

Features:

- Operates from IC without predriver

Applications:

- Power switching
- Audio amplifiers
- Hammer drivers
- Series and shunt regulators

TERMINAL DESIGNATIONS

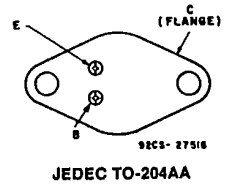

The 2N6648, 2N6649 and 2N6650* are monolithic silicon p-n-p Darlington transistors designed for low- and medium-frequency power applications. The high gain of these devices makes it possible for them to be driven directly from integrated circuits. They are complementary to the 2N6383, 2N6384, and 2N6385[▲].

The 2N6648, 2N6649, and 2N6650 are supplied in hermetic steel JEDEC TO-204AA packages.

* Formerly RCA Dev. Nos. TA8351, TA8488, and TA8350, respectively.

[▲] Technical data for 2N6383, 2N6384, and 2N6385 are given in RCA bulletin File No. 609.

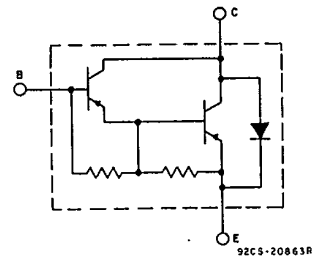

Fig. 1 - Schematic diagram for all types.

MAXIMUM RATINGS, Absolute-Maximum Values:

	2N6648	2N6649	2N6650	
* V_{CBO}	-40	-60	-80	V
$V_{CER(sus)}$ $R_{BE} = 100 \Omega$	-40	-60	-80	V
* $V_{CEO(sus)}$	-40	-60	-80	V
$V_{CEV(sus)}$ $V_{BE} = -1.5 V$	-40	-60	-80	V
* V_{EBO}	-5	-5	-5	V
* I_C	-10	-10	-10	A
I_{CM}	-15	-15	-15	A
* I_B	-0.25	-0.25	-0.25	A
* P_T $T_C \leq 25^\circ C$	70	70	70	W
$T_C > 25^\circ C$	Derate linearly			W/ $^\circ C$
* T_{stg}, T_J	-65 to +150			$^\circ C$
* T_L At distances $\geq 1/32$ in. (0.8 mm) from seating plane for 10 s max.	235			$^\circ C$

* In accordance with JEDEC registration data format (JS-6 RDF-4)

2N6648, 2N6649, 2N6650

ELECTRICAL CHARACTERISTICS, At Case Temperature (T_C) = 25°C Unless Otherwise Specified

CHARACTERISTIC	TEST CONDITIONS				LIMITS						UNITS	
	VOLTAGE V _{dc}		CURRENT A _{dc}		2N6648		2N6649		2N6650			
	V _{CE}	V _{BE}	I _C	I _B	MIN.	MAX.	MIN.	MAX.	MIN.	MAX.		
I _{CEO}	-40 -60 -80			0 0 0	-	-1	-	-	-	-1	-	mA
* I _{CEV}	-40 -60 -80	1.5 1.5 1.5			-	-0.3	-	-	-	-	-0.3	
T _C = 150°C	-40 -60 -80	1.5 1.5 1.5			-	-3	-	-	-	-	-3	
* I _{EBO}		5	0		-	-10	-	-10	-	-10	-	mA
* V _{CEO(sus)}			-0.2 ^a	0	-40	-	-60	-	-80	-	-	V
V _{CER(sus)} R _{BE} = 100 Ω			-0.2 ^a		-40	-	-60	-	-80	-	-	V
V _{CEV(sus)}		1.5	-0.2 ^a		-40	-	-60	-	-80	-	-	V
* h _{FE}	-3 -3		-5 ^a -10 ^a		1000 100	20,000	1000 100	20,000	1000 100	20,000		
V _{BE}	-3 -3		-5 ^a -10 ^a		-	-2.8 -4.5*	-	-2.8 -4.5*	-	-2.8 -4.5*		V
V _{CE(sat)}			-5 ^a -10 ^a	-0.01 ^a -0.1 ^a	-	-2 -3*	-	-2 -3*	-	-2 -3*		V
V _F			10 ^a		-	4	-	4	-	4		V
h _{fe} f = 1 kHz	-5		-1		1000	-	1000	-	1000	-		
* h _{fe} f = 1 MHz	-5		-1		20	-	20	-	20	-		
I _{S/b} t = 1 s, nonrep.	-35 -25				-1 -2.8	-	-1 -2.8	-	-1 -2.8	-		A
R _{θJC}					-	1.75	-	1.75	-	1.75		°C/W

* In accordance with JEDEC registration data format (JS-6 RDF-4).

^a Pulsed: Pulse duration = 300 μs, duty factor = 1.8%.

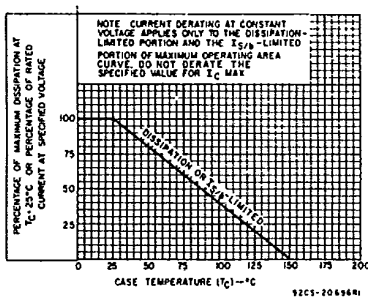

Fig. 2 — Derating curve for all types.

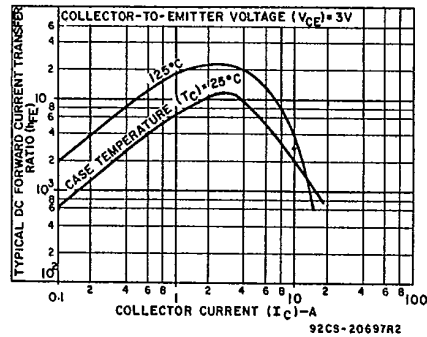

Fig. 3 — Typical dc beta characteristics for all types.

3875081 G E SOLID STATE
Darlington Power Transistors

01E 17266 D T-33-29

2N6648, 2N6649, 2N6650

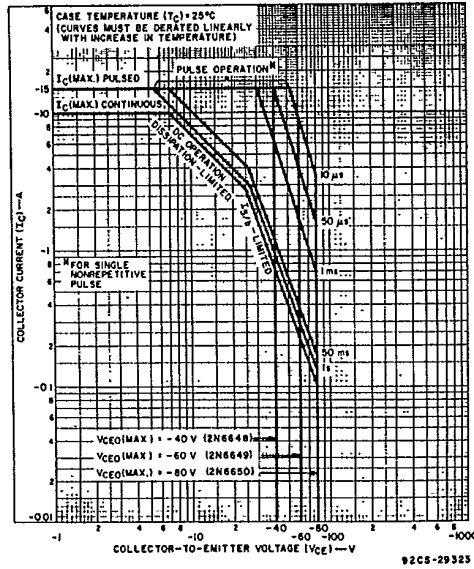

Fig. 4 — Maximum operating areas for all types.

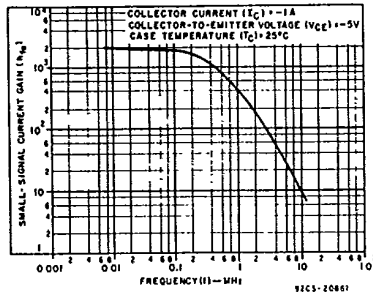

Fig. 5 — Typical small-signal gain for all types.

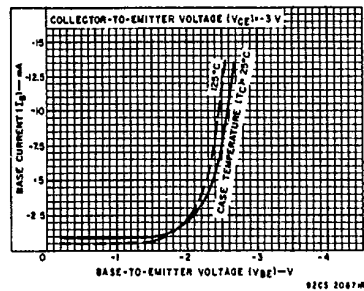

Fig. 6 — Typical input characteristics for all types.

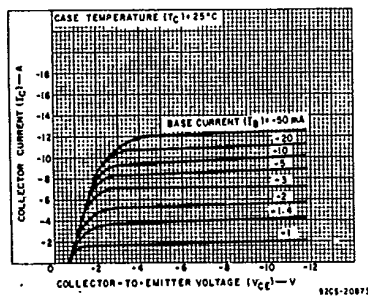

Fig. 7 — Typical output characteristics for all types.

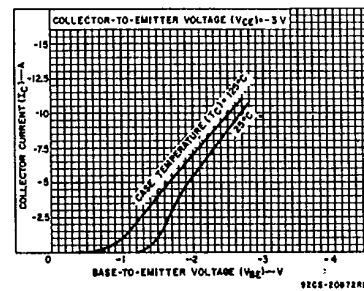

Fig. 8 — Typical transfer characteristics for all types.

2N6648, 2N6649, 2N6650

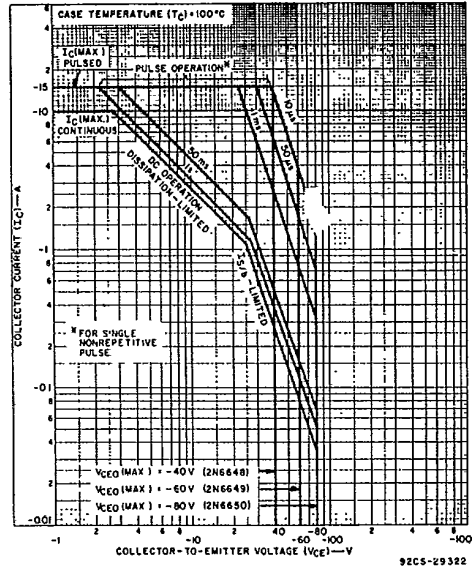

Fig. 9 — Maximum operating areas for all types at $T_c = 100^\circ C$.

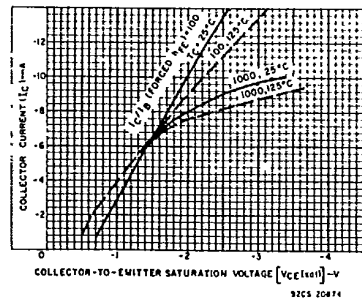

Fig. 10 — Typical saturation characteristics for all types.

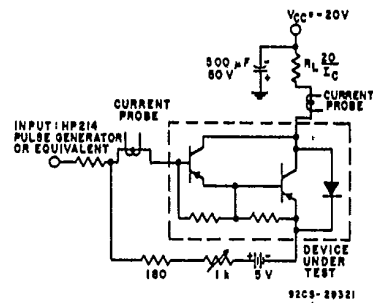

Fig. 11 — Circuit used to measure saturated switching times.

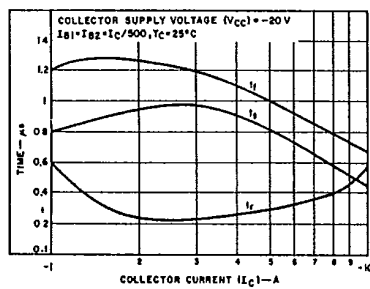

Fig. 12 — Typical saturated switching-time characteristics for all types.

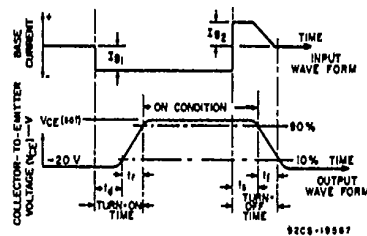

Fig. 13 — Phase relationship between input current and output current showing reference points for specification of switching times.