

DF 005M ...DF 10M

MINIATURE GLASS PASSIVATED SINGLE - PHASE - BRIDGE RECTIFIER

Features

- Plastic package used has Underwriters Laboratory Flammability Classification 94V-0
- Glass passivated chip junctions
- Surge overload rating of 50 Amperes peak
- Ideal for printed circuit boards
- High temperature soldering guaranteed: 260 °C/10 seconds at 5 lbs. (2.3 Kg) tension

Mechanical Rating

- Case: Molded plastic body over passivated junctions
- Terminals: Plated lead solderable per MIL-STD-750, Method 2026
- Polarity: polarity symbols marked on body
- Mounting Position: Any
- Weight: 0.04 ounce, 1.0 gram

Case Style DFM

2 : 1

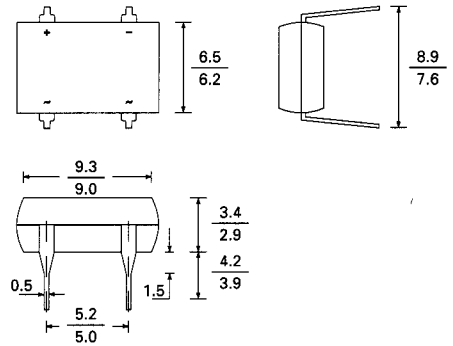

Maximum Ratings and Electrical Characteristics

Ratings at 25 °C ambient temperature unless otherwise specified.

Characteristic	Symbol	DF 005M	DF 01M	DF 02M	DF 04M	DF 06M	DF 08M	DF 10M	Unit
Maximum repetitive peak reverse voltage	V_{RRM}	50	100	200	400	600	800	1000	volts
Maximum RMS voltage	V_{RMS}	35	70	140	280	420	560	700	volts
Maximum DC blocking voltage	V_{DC}	50	100	200	400	600	800	1000	volts
Maximum average forward output rectified current at $T_A=40\text{ °C}$	$I_{(AV)}$	1.0							Amp
Peak forward surge current single sine-wave Suprimposed on rated load (JEDEC Method)	I_{FSM}	50.0							Amp
Rating for using ($t<8.35\text{ms}$)	I^2t	10.0							$A^2\text{SEC}$
Maximum instantaneous forward voltage drop per leg at 1.0A	V_F	1.1							Volts
Maximum reverse current at rated DC blocking voltage per leg	I_R	5.0 500.0							μA
Typical junction capacitance per leg (Note 1)	C_J	25.0							pF
Typical thermal resistance per leg (Note 2)	$R_{\theta JA}$ $R_{\theta JL}$	40.0 15.0							$^{\circ}\text{C/W}$
Operating junction and storage temperature range	T_J, T_{STG}	-55 to + 150							$^{\circ}\text{C}$

NOTES:

- (1) Measured at 1.0 MHz and applied reverse voltage of 4.0 volts
- (2) Thermal resistance from junction to ambient and from junction to lead mounted on P.C.B. with 0.5X0.5" (13X13mm) copper pads

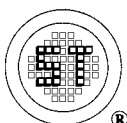

SEMTECH ELECTRONICS LTD.

(wholly owned subsidiary of HONEY TECHNOLOGY LTD.)



FIG. 1-DERATING CURVE OUTPUT RECTIFIED CURRENT

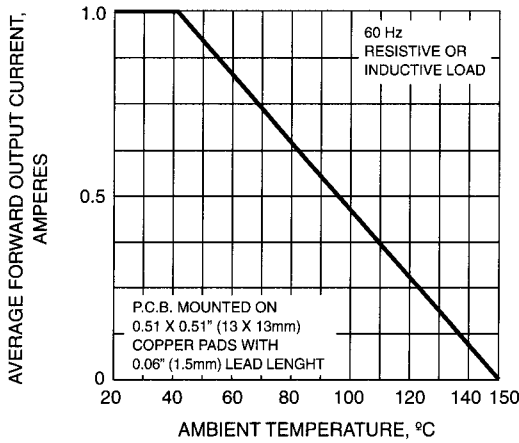

FIG. 2-MAXIMUM NON-REPETITIVE PEAK FORWARD SURGE CURRENT PER LEG

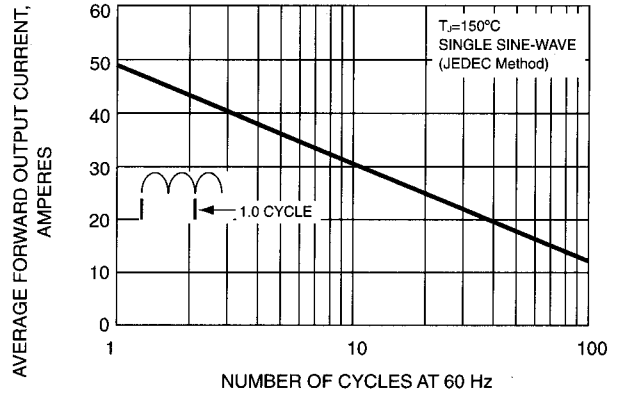

FIG. 3-TYPICAL FORWARD CHARACTERISTICS PER LEG

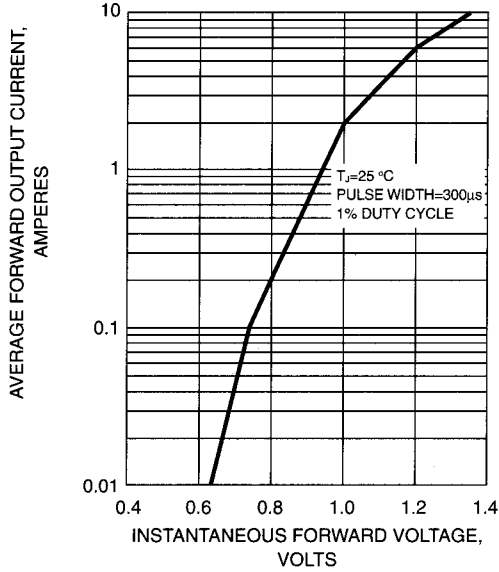

FIG. 4-TYPICAL REVERSE LEAKAGE CHARACTERISTICS PER LEG

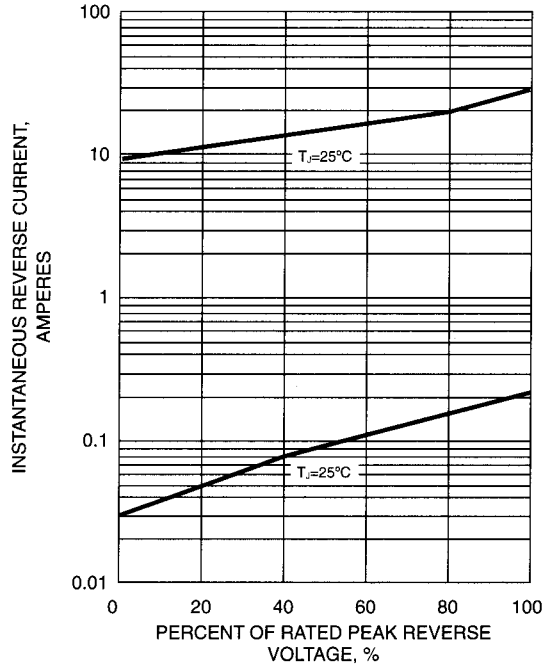

FIG. 5-TYPICAL JUNCTION CAPACITANCE PER LEG

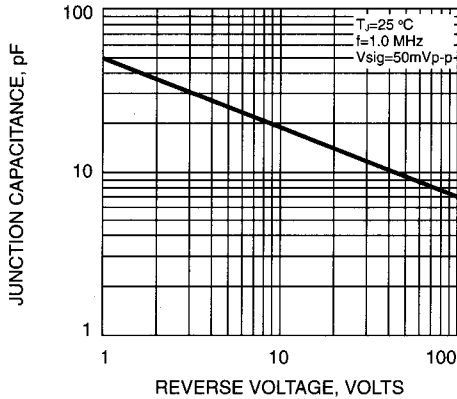

FIG. 6-TYPICAL TRANSIENT THERMAL IMPEDANCE

