

2N7002T

N-Channel Enhancement Mode Field Effect Transistor

Features

- Low On-Resistance
- Low Gate Threshold Voltage
- Low Input Capacitance
- Fast Switching Speed
- Low Input/Output Leakage
- Ultra-Small Surface Mount Package
- Lead Free/RoHS Compliant

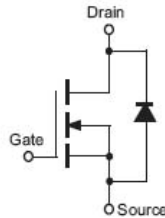
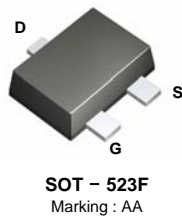

Absolute Maximum Ratings * $T_a = 25^\circ\text{C}$ unless otherwise noted

Symbol	Parameter	Value	Units
V_{DSS}	Drain-Source Voltage	60	V
V_{DGR}	Drain-Gate Voltage $R_{GS} \leq 1.0M\Omega$	60	V
V_{GSS}	Gate-Source Voltage	Continuous	± 20
		Pulsed	± 40
I_D	Drain Current	Continuous	115
		Continuous @ 100°C	73
		Pulsed	800
T_J	Junction Temperature	150	$^\circ\text{C}$
T_{STG}	Storage Temperature Range	-55 to +150	$^\circ\text{C}$

* These ratings are limiting values above which the serviceability of any semiconductor device may be impaired.

Thermal Characteristics

Symbol	Parameter	Value	Units
P_D	Total Device Dissipation Derating above $T_A = 25^\circ\text{C}$	200	mW
		1.6	mW/ $^\circ\text{C}$
$R_{\theta JA}$	Thermal Resistance, Junction to Ambient *	625	$^\circ\text{C}/\text{W}$

* Device mounted on FR-4 PCB, 1 inch x 0.85 inch x 0.062 inch. Minimum land pad size,

Electrical Characteristics $T_C = 25^\circ\text{C}$ unless otherwise noted

Symbol	Parameter	Test Condition	MIN	TYP	MAX	Units
--------	-----------	----------------	-----	-----	-----	-------

Off Characteristics (Note1)

BV_{DSS}	Drain-Source Breakdown Voltage	$V_{GS} = 0V, I_D = 10\mu A$	60	78	-	V
I_{DSS}	Zero Gate Voltage Drain Current	$V_{DS} = 60V, V_{GS} = 0V$ $V_{DS} = 60V, V_{GS} = 0V, @T_C = 125^\circ\text{C}$	-	0.001 7	1.0 500	μA
I_{GSS}	Gate-Body Leakage	$V_{GS} = \pm 20V, V_{DS} = 0V$	-	0.2	± 10	nA

On Characteristics (Note1)

$V_{GS(th)}$	Gate Threshold Voltage	$V_{DS} = V_{GS}, I_D = 250\mu A$	1.0	1.76	2.0	V
$R_{DS(ON)}$	Satic Drain-Source On-Resistance	$V_{GS} = 5V, I_D = 0.05A,$ $V_{GS} = 10V, I_D = 0.5A, @T_j = 125^\circ\text{C}$	- -	1.6 2.53	7.5 13.5	Ω
$I_{D(ON)}$	On-State Drain Current	$V_{GS} = 10V, V_{DS} = 7.5V$	0.5	1.43	-	A
g_{FS}	Forward Transconductance	$V_{DS} = 10V, I_D = 0.2A$	80	356.5	-	mS

Dynamic Characteristics

C_{iss}	Input Capacitance	$V_{DS} = 25V, V_{GS} = 0V, f = 1.0\text{MHz}$	-	37.8	50	pF
C_{oss}	Output Capacitance		-	12.4	25	pF
C_{rss}	Reverse Transfer Capacitance		-	6.5	7.0	pF

Switching Characteristics

$t_{D(ON)}$	Turn-On Delay Time	$V_{DD} = 30V, I_D = 0.2A, V_{GEN} = 10V$ $R_L = 150\Omega, R_{GEN} = 25\Omega$	-	5.85	20	ns
$t_{D(OFF)}$	Turn-Off Delay Time		-	12.5	20	

Note1 : Short duration test pulse used to minimize self-heating effect.

Typical Performance Characteristics

Figure 1. On-Region Characteristics

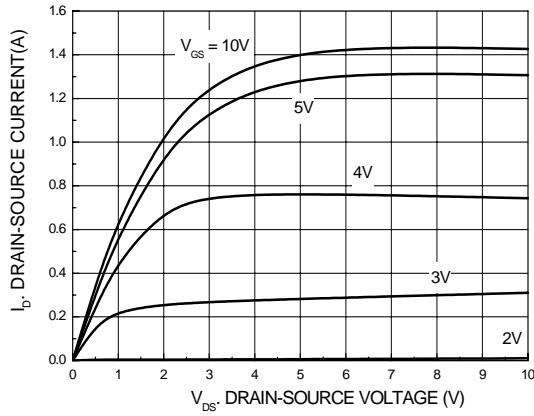

Figure 2. On-Resistance Variation with Gate Voltage and Drain Current

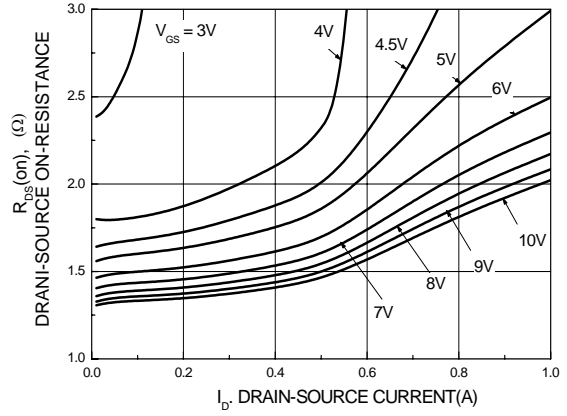

Figure 3. On-Resistance Variation with Temperature

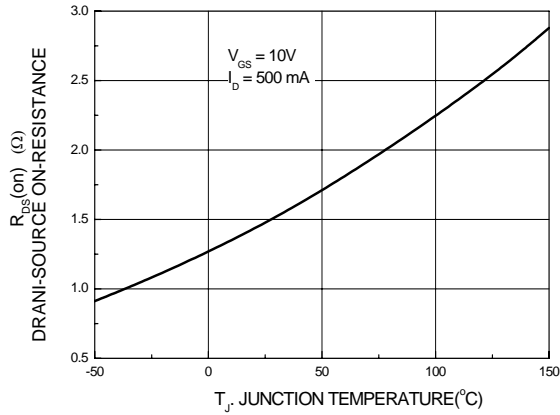

Figure 4. On-Resistance Variation with Gate-Source Voltage

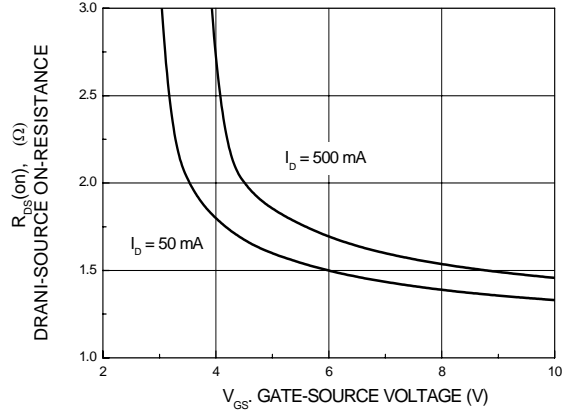

Figure 5. Transfer Characteristics

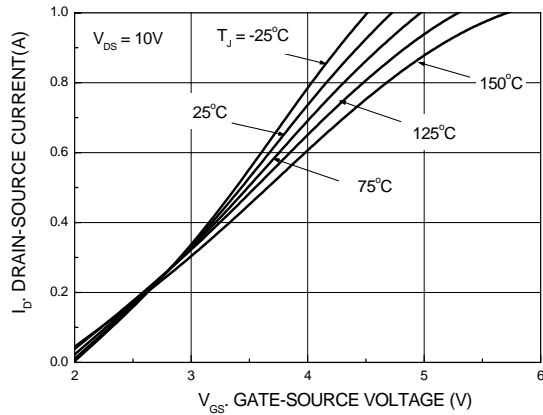
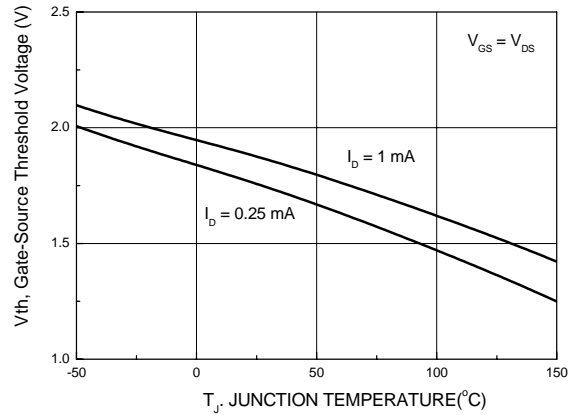

Figure 6. Gate Threshold Variation with Temperature



Typical Performance Characteristics

Figure 7. Reverse Drain Current Variation with Diode Forward Voltage and Temperature

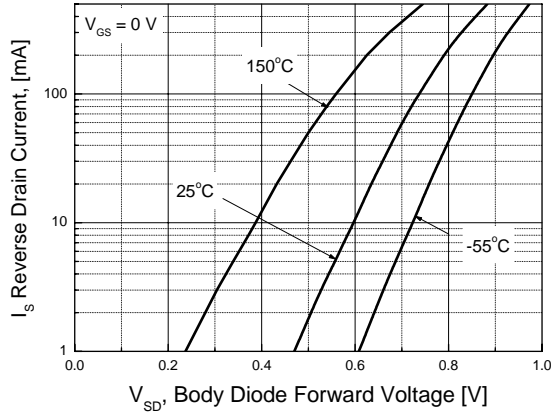
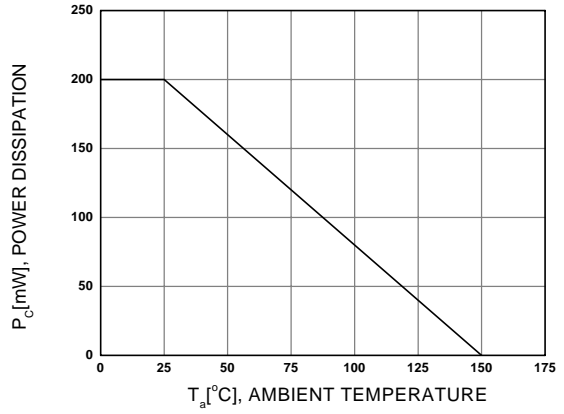
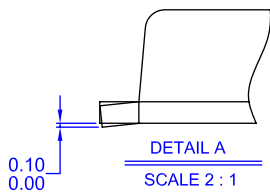
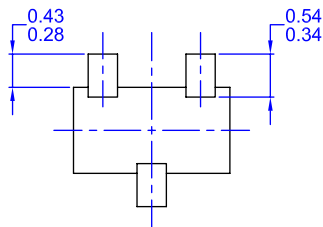
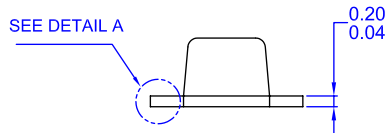
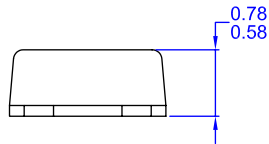
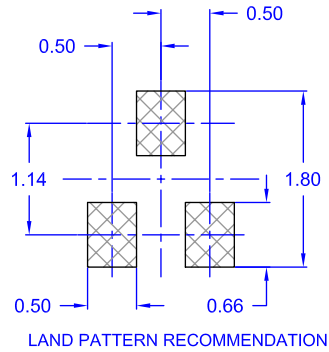
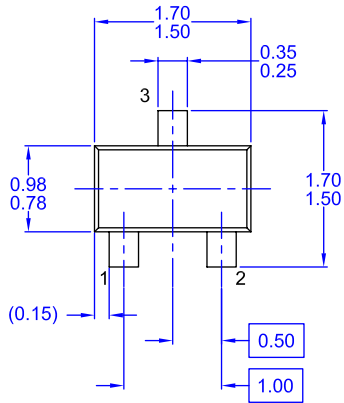

Figure 8. Power Derating



Package Dimensions

SOT-523F



- NOTES: UNLESS OTHERWISE SPECIFIED
 A) THIS PACKAGE CONFORMS TO EIAJ SC89 PACKAGING STANDARD.
 B) ALL DIMENSIONS ARE IN MILLIMETERS.
 C) DIMENSIONS ARE EXCLUSIVE OF BURRS, MOLD FLASH, AND TIE BAR EXTRUSIONS.

Dimensions in Millimeters



TRADEMARKS

The following are registered and unregistered trademarks and service marks Fairchild Semiconductor owns or is authorized to use and is not intended to be an exhaustive list of all such trademarks.

ACEx®	Green FPS™	Power247®	SuperSOT™-8
Build it Now™	Green FPS™ e-Series™	POWEREDGE®	SyncFET™
CorePLUS™	GTO™	Power-SPM™	The Power Franchise®
CROSSVOLT™	<i>i-Lo</i> ™	PowerTrench®	power franchise
CTL™	IntelliMAX™	Programmable Active Droop™	TinyBoost™
Current Transfer Logic™	ISOPLANAR™	QFET®	TinyBuck™
EcoSPARK®	MegaBuck™	QS™	TinyLogic®
F ®	MICROCOUPLER™	QT Optoelectronics™	TINYOPTO™
Fairchild®	MicroFET™	Quiet Series™	TinyPower™
Fairchild Semiconductor®	MicroPak™	RapidConfigure™	TinyPWM™
FACT Quiet Series™	Motion-SPM™	SMART START™	TinyWire™
FACT®	OPTOLOGIC®	SPM®	µSerDes™
FAST®	OPTOPLANAR®	STEALTH™	UHC®
FastvCore™	 ®	SuperFET™	UniFET™
FPS™	PDP-SPM™	SuperSOT™-3	VCX™
FRFET®	Power220®	SuperSOT™-6	
Global Power Resource SM			

DISCLAIMER

FAIRCHILD SEMICONDUCTOR RESERVES THE RIGHT TO MAKE CHANGES WITHOUT FURTHER NOTICE TO ANY PRODUCTS HEREIN TO IMPROVE RELIABILITY, FUNCTION, OR DESIGN. FAIRCHILD DOES NOT ASSUME ANY LIABILITY ARISING OUT OF THE APPLICATION OR USE OF ANY PRODUCT OR CIRCUIT DESCRIBED HEREIN; NEITHER DOES IT CONVEY ANY LICENSE UNDER ITS PATENT RIGHTS, NOR THE RIGHTS OF OTHERS. THESE SPECIFICATIONS DO NOT EXPAND THE TERMS OF FAIRCHILD'S WORLDWIDE TERMS AND CONDITIONS, SPECIFICALLY THE WARRANTY THEREIN, WHICH COVERS THESE PRODUCTS.

LIFE SUPPORT POLICY

FAIRCHILD'S PRODUCTS ARE NOT AUTHORIZED FOR USE AS CRITICAL COMPONENTS IN LIFE SUPPORT DEVICES OR SYSTEMS WITHOUT THE EXPRESS WRITTEN APPROVAL OF FAIRCHILD SEMICONDUCTOR CORPORATION.

As used herein:

1. Life support devices or systems are devices or systems which, (a) are intended for surgical implant into the body, or (b) support or sustain life, and (c) whose failure to perform when properly used in accordance with instructions for use provided in the labeling, can be reasonably expected to result in significant injury to the user.
2. A critical component is any component of a life support device or system whose failure to perform can be reasonably expected to cause the failure of the life support device or system, or to affect its safety or effectiveness.

PRODUCT STATUS DEFINITIONS

Definition of Terms

Datasheet Identification	Product Status	Definition
Advance Information	Formative or In Design	This datasheet contains the design specifications for product development. Specifications may change in any manner without notice.
Preliminary	First Production	This datasheet contains preliminary data; supplementary data will be published at a later date. Fairchild Semiconductor reserves the right to make changes at any time without notice to improve design.
No Identification Needed	Full Production	This datasheet contains final specifications. Fairchild Semiconductor reserves the right to make changes at any time without notice to improve design.
Obsolete	Not In Production	This datasheet contains specifications on a product that has been discontinued by Fairchild semiconductor. The datasheet is printed for reference information only.

Rev. I30