

**70A, 600V, UFS Series N-Channel IGBT**

The HGTG40N60B3 is a MOS gated high voltage switching device combining the best features of MOSFETs and bipolar transistors. The device has the high input impedance of a MOSFET and the low on-state conduction loss of a bipolar transistor. The much lower on-state voltage drop varies only moderately between 25°C and 150°C.

The IGBT is ideal for many high voltage switching applications operating at moderate frequencies where low conduction losses are essential, such as: AC and DC motor controls, power supplies and drivers for solenoids, relays and contactors.

Formerly Developmental Type TA49052.

**Ordering Information**

| PART NUMBER | PACKAGE | BRAND    |
|-------------|---------|----------|
| HGTG40N60B3 | TO-247  | G40N60B3 |

NOTE: When ordering, use the entire part number.

**Symbol**

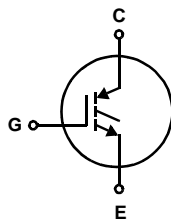

**Features**

- 70A, 600V,  $T_C = 25^\circ\text{C}$
- 600V Switching SOA Capability
- Typical Fall Time. . . . . 100ns at  $T_J = 150^\circ\text{C}$
- Short Circuit Rating
- Low Conduction Loss

**Packaging**

JEDEC STYLE TO-247

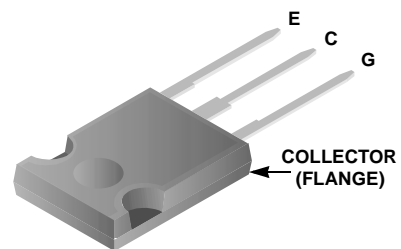

**FAIRCHILD CORPORATION IGBT PRODUCT IS COVERED BY ONE OR MORE OF THE FOLLOWING U.S. PATENTS**

|           |           |           |           |           |           |           |           |
|-----------|-----------|-----------|-----------|-----------|-----------|-----------|-----------|
| 4,364,073 | 4,417,385 | 4,430,792 | 4,443,931 | 4,466,176 | 4,516,143 | 4,532,534 | 4,587,713 |
| 4,598,461 | 4,605,948 | 4,620,211 | 4,631,564 | 4,639,754 | 4,639,762 | 4,641,162 | 4,644,637 |
| 4,682,195 | 4,684,413 | 4,694,313 | 4,717,679 | 4,743,952 | 4,783,690 | 4,794,432 | 4,801,986 |
| 4,803,533 | 4,809,045 | 4,809,047 | 4,810,665 | 4,823,176 | 4,837,606 | 4,860,080 | 4,883,767 |
| 4,888,627 | 4,890,143 | 4,901,127 | 4,904,609 | 4,933,740 | 4,963,951 | 4,969,027 |           |

# HGTG40N60B3

## Absolute Maximum Ratings $T_C = 25^\circ\text{C}$ , Unless Otherwise Specified

|   | HGTG40N60B3    | UNITS                          |
|---|----------------|--------------------------------|
| Collector to Emitter Voltage . . . . .  | $BV_{CES}$     | 600 V                          |
| Collector Current Continuous  |                |                                |
| At $T_C = 25^\circ\text{C}$ . . . . .   | $I_{C25}$      | 70 A                           |
| At $T_C = 110^\circ\text{C}$ . . . . .  | $I_{C110}$     | 40 A                           |
| Collector Current Pulsed (Note 1) . . . . .                                     | $I_{CM}$       | 330 A                          |
| Gate to Emitter Voltage Continuous . . . . .                                    | $V_{GES}$      | $\pm 20$ V                     |
| Gate to Emitter Voltage Pulsed . . . . .  | $V_{GEM}$      | $\pm 30$ V                     |
| Switching Safe Operating Area at $T_J = 150^\circ\text{C}$ , Figure 2 . . . . . | SSOA           | 100A at 600V                   |
| Power Dissipation Total at $T_C = 25^\circ\text{C}$ . . . . .                   | $P_D$          | 290 W                          |
| Power Dissipation Derating $T_C > 25^\circ\text{C}$ . . . . .                   |                | 2.33 $\text{W}/^\circ\text{C}$ |
| Reverse Voltage Avalanche Energy . . . . .                                      | $E_{ARV}$      | 100 mJ                         |
| Operating and Storage Junction Temperature Range . . . . .                      | $T_J, T_{STG}$ | -55 to 150 $^\circ\text{C}$    |
| Maximum Lead Temperature for Soldering . . . . .                                | $T_L$          | 260 $^\circ\text{C}$           |
| Short Circuit Withstand Time (Note 2) at $V_{GE} = 15\text{V}$ . . . . .        | $t_{SC}$       | 2 $\mu\text{s}$                |
| Short Circuit Withstand Time (Note 2) at $V_{GE} = 10\text{V}$ . . . . .        | $t_{SC}$       | 10 $\mu\text{s}$               |

CAUTION: Stresses above those listed in "Absolute Maximum Ratings" may cause permanent damage to the device. This is a stress only rating and operation of the device at these or any other conditions above those indicated in the operational sections of this specification is not implied.

### NOTES:

1. Pulse width limited by maximum junction temperature.
2.  $V_{CE(PK)} = 360\text{V}$ ,  $T_J = 125^\circ\text{C}$ ,  $R_G = 3\Omega$

## Electrical Specifications $T_C = 25^\circ\text{C}$ , Unless Otherwise Specified

| PARAMETER                               | SYMBOL        | TEST CONDITIONS   | MIN | TYP  | MAX       | UNITS         |
|---|---------------|---|-----|------|-----------|---------------|
| Collector to Emitter Breakdown Voltage  | $BV_{CES}$    | $I_C = 250\mu\text{A}$ , $V_{GE} = 0\text{V}$   | 600 | -    | -         | V             |
| Emitter to Collector Breakdown Voltage  | $BV_{ECS}$    | $I_C = -10\text{mA}$ , $V_{GE} = 0\text{V}$   | 20  | -    | -         | V             |
| Collector to Emitter Leakage Current    | $I_{CES}$     | $V_{CE} = BV_{CES}$ , $T_C = 25^\circ\text{C}$  | -   | -    | 100       | $\mu\text{A}$ |
|   |               | $V_{CE} = BV_{CES}$ , $T_C = 150^\circ\text{C}$   | -   | -    | 6.0       | mA            |
| Collector to Emitter Saturation Voltage | $V_{CE(SAT)}$ | $I_C = I_{C110}$ , $V_{GE} = 15\text{V}$ , $T_C = 25^\circ\text{C}$   | -   | 1.4  | 2.0       | V             |
|   |               | $T_C = 150^\circ\text{C}$   | -   | 1.5  | 2.3       | V             |
| Gate to Emitter Threshold Voltage       | $V_{GE(TH)}$  | $I_C = 250\mu\text{A}$ , $V_{CE} = V_{GE}$  | 3.0 | 4.8  | 6.0       | V             |
| Gate to Emitter Leakage Current         | $I_{GES}$     | $V_{GE} = \pm 20\text{V}$   | -   | -    | $\pm 100$ | nA            |
| Switching SOA                           | SSOA          | $T_J = 150^\circ\text{C}$ , $R_G = 3\Omega$ , $V_{GE} = 15\text{V}$ , $L = 100\mu\text{H}$ , $V_{CE} = 480\text{V}$   | 200 | -    | -         | A             |
|   |               | $V_{CE} = 600\text{V}$  | 100 | -    | -         | A             |
| Gate to Emitter Plateau Voltage         | $V_{GEP}$     | $I_C = I_{C110}$ , $V_{CE} = 0.5 BV_{CES}$  | -   | 7.5  | -         | V             |
| On-State Gate Charge                    | $Q_{G(ON)}$   | $I_C = I_{C110}$ , $V_{CE} = 0.5 BV_{CES}$ , $V_{GE} = 15\text{V}$  | -   | 250  | 330       | nC            |
|   |               | $V_{GE} = 20\text{V}$   | -   | 335  | 435       | nC            |
| Current Turn-On Delay Time              | $t_{d(ON)I}$  | IGBT and Diode Both at $T_J = 25^\circ\text{C}$<br>$I_{CE} = I_{C110}$<br>$V_{CE} = 0.8 BV_{CES}$<br>$V_{GE} = 15\text{V}$<br>$R_G = 3\Omega$<br>$L = 100\mu\text{H}$<br>Test Circuit (Figure 17) | -   | 47   | -         | ns            |
| Current Rise Time                       | $t_{rI}$      |   | -   | 35   | -         | ns            |
| Current Turn-Off Delay Time             | $t_{d(OFF)I}$ |   | -   | 170  | 200       | ns            |
| Current Fall Time                       | $t_{fI}$      |   | -   | 50   | 100       | ns            |
| Turn-On Energy                          | $E_{ON}$      |   | -   | 1050 | 1200      | $\mu\text{J}$ |
| Turn-Off Energy (Note 1)                | $E_{OFF}$     |   | -   | 800  | 1400      | $\mu\text{J}$ |

# HGTG40N60B3

## Electrical Specifications $T_C = 25^\circ\text{C}$ , Unless Otherwise Specified (Continued)

| PARAMETER                           | SYMBOL          | TEST CONDITIONS   | MIN | TYP  | MAX  | UNITS                     |
|-------------------------------------|-----------------|---|-----|------|------|---------------------------|
| Current Turn-On Delay Time          | $t_{d(ON)}$     | IGBT and Diode Both at $T_J = 150^\circ\text{C}$<br>$I_{CE} = I_{C110}$<br>$V_{CE} = 0.8 V_{CES}$<br>$V_{GE} = 15\text{V}$<br>$R_G = 3\Omega$<br>$L = 100\mu\text{H}$<br>Test Circuit (Figure 17) | -   | 47   | -    | ns                        |
| Current Rise Time                   | $t_{rl}$        |   | -   | 35   | -    | ns                        |
| Current Turn-Off Delay Time         | $t_{d(OFF)}$    |   | -   | 285  | 375  | ns                        |
| Current Fall Time                   | $t_{fl}$        |   | -   | 100  | 175  | ns                        |
| Turn-On Energy                      | $E_{ON}$        |   | -   | 1850 | -    | $\mu\text{J}$             |
| Turn-Off Energy (Note 1)            | $E_{OFF}$       |   | -   | 2000 | -    | $\mu\text{J}$             |
| Thermal Resistance Junction To Case | $R_{\theta JC}$ |   | -   | -    | 0.43 | $^\circ\text{C}/\text{W}$ |

### NOTE:

- Turn-Off Energy Loss ( $E_{OFF}$ ) is defined as the integral of the instantaneous power loss starting at the trailing edge of the input pulse and ending at the point where the collector current equals zero ( $I_{CE} = 0\text{A}$ ). All devices were tested per JEDEC Standard No. 24-1 Method for Measurement of Power Device Turn-Off Switching Loss. This test method produces the true total Turn-Off Energy Loss. Turn-On losses include losses due to diode recovery.

## Typical Performance Curves (Unless Otherwise Specified)

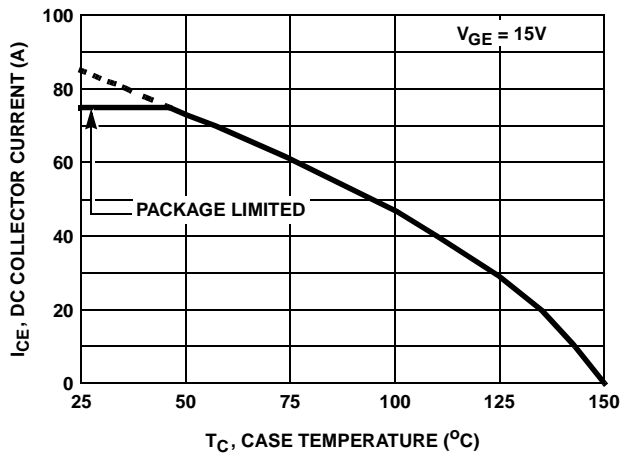

FIGURE 1. DC COLLECTOR CURRENT vs CASE TEMPERATURE

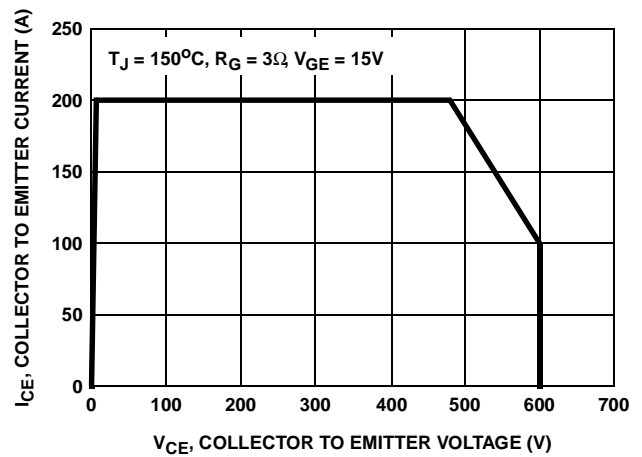

FIGURE 2. MINIMUM SWITCHING SAFE OPERATING AREA

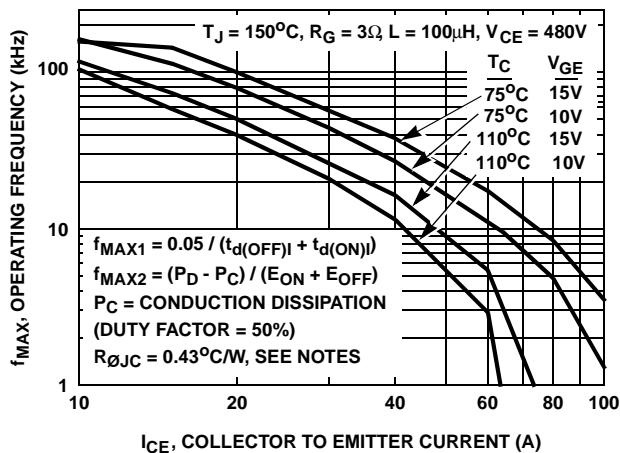

FIGURE 3. OPERATING FREQUENCY vs COLLECTOR TO EMITTER CURRENT

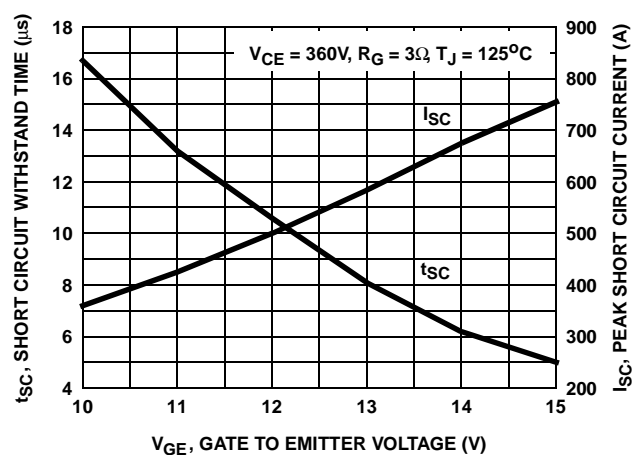

FIGURE 4. SHORT CIRCUIT WITHSTAND TIME

Typical Performance Curves (Unless Otherwise Specified) (Continued)

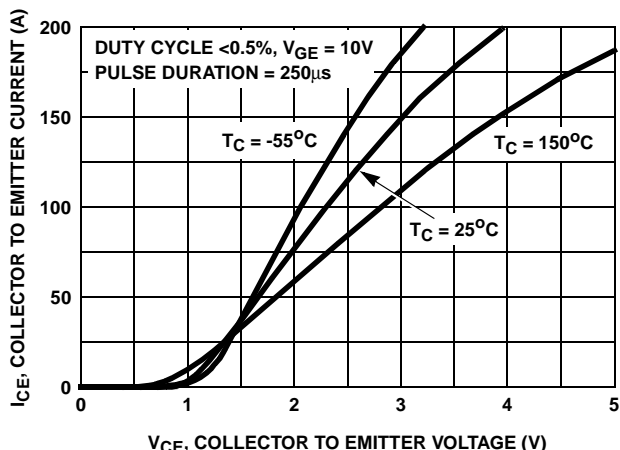

FIGURE 5. COLLECTOR TO EMITTER ON STATE VOLTAGE

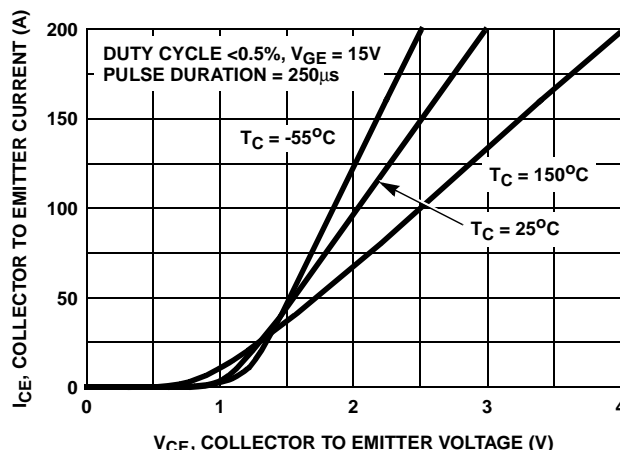

FIGURE 6. COLLECTOR TO EMITTER ON STATE VOLTAGE

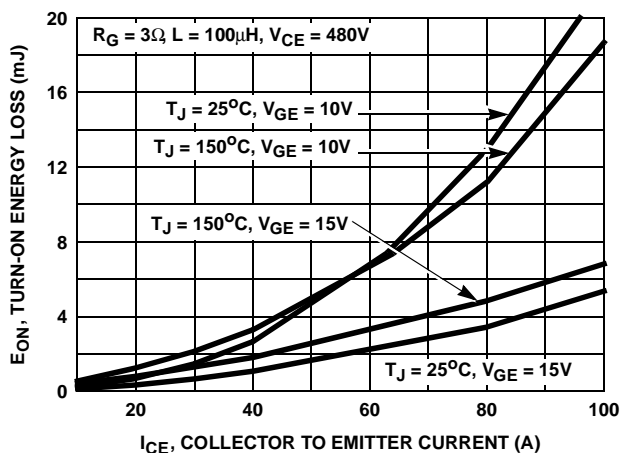

FIGURE 7. TURN-ON ENERGY LOSS vs COLLECTOR TO EMITTER CURRENT

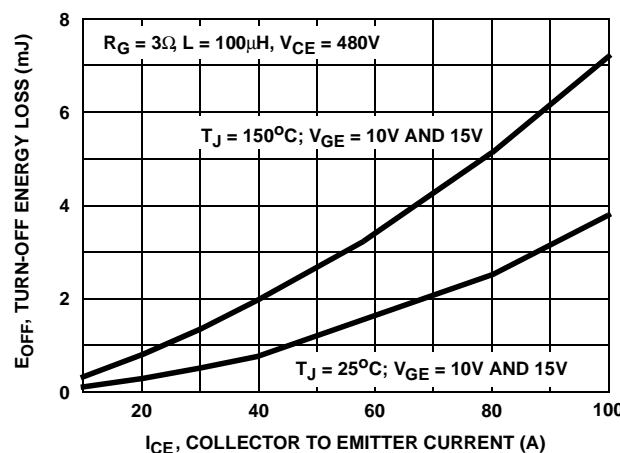

FIGURE 8. TURN-OFF ENERGY LOSS vs COLLECTOR TO EMITTER CURRENT

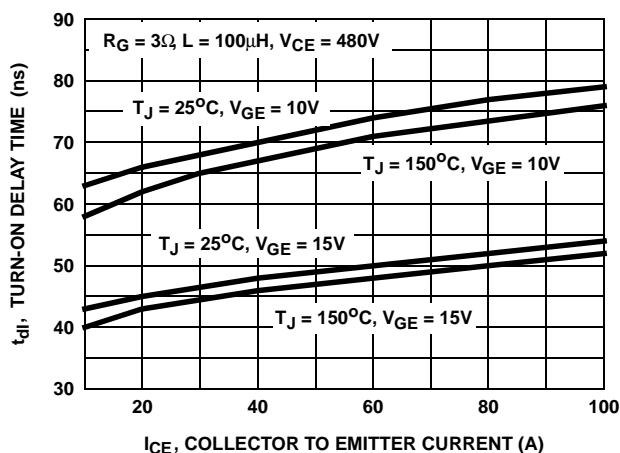

FIGURE 9. TURN-ON DELAY TIME vs COLLECTOR TO EMITTER CURRENT

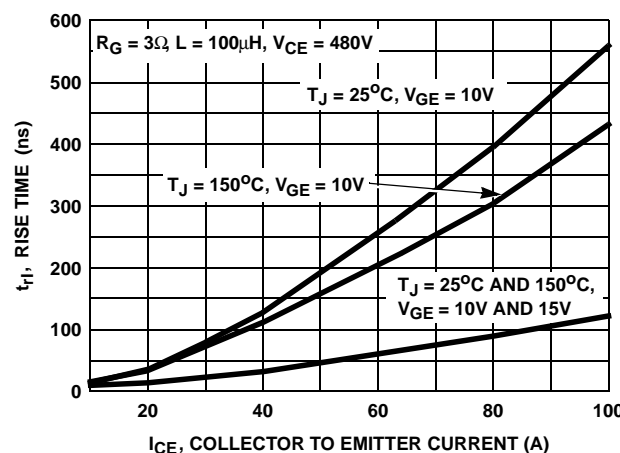

FIGURE 10. TURN-ON RISE TIME vs COLLECTOR TO EMITTER CURRENT

Typical Performance Curves (Unless Otherwise Specified) (Continued)

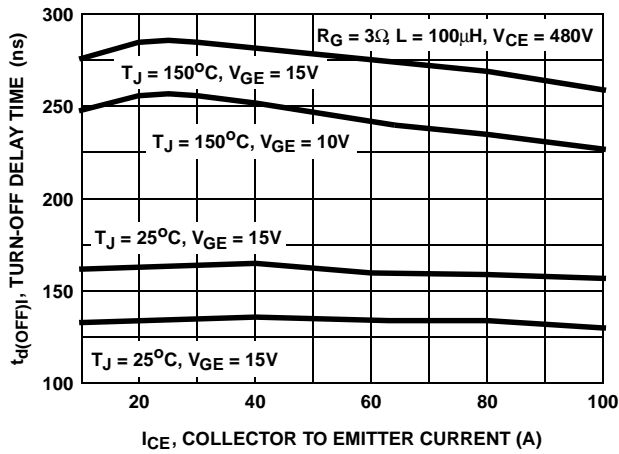

FIGURE 11. TURN-OFF DELAY TIME vs COLLECTOR TO EMITTER CURRENT

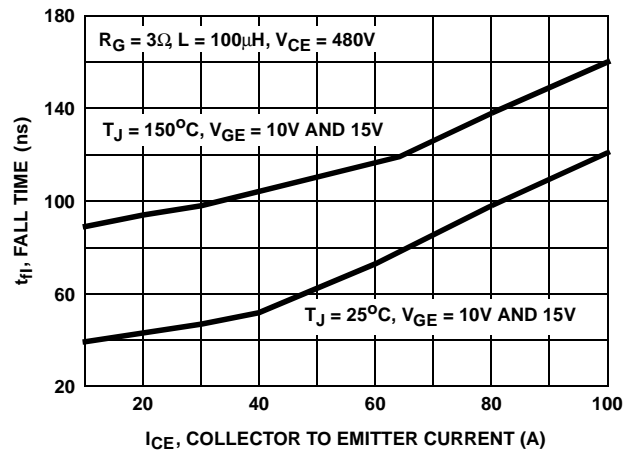

FIGURE 12. FALL TIME vs COLLECTOR TO EMITTER CURRENT

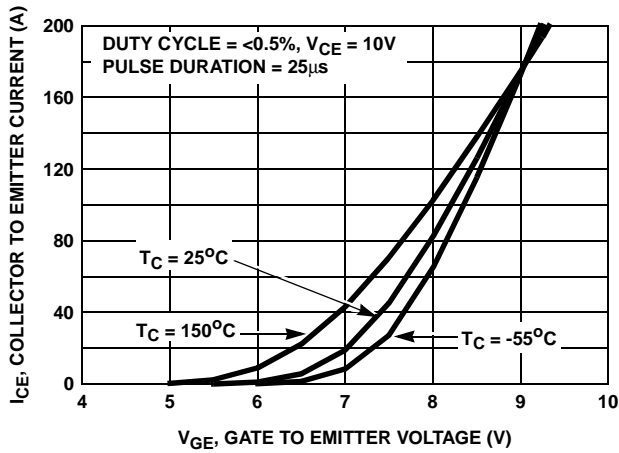

FIGURE 13. TRANSFER CHARACTERISTIC

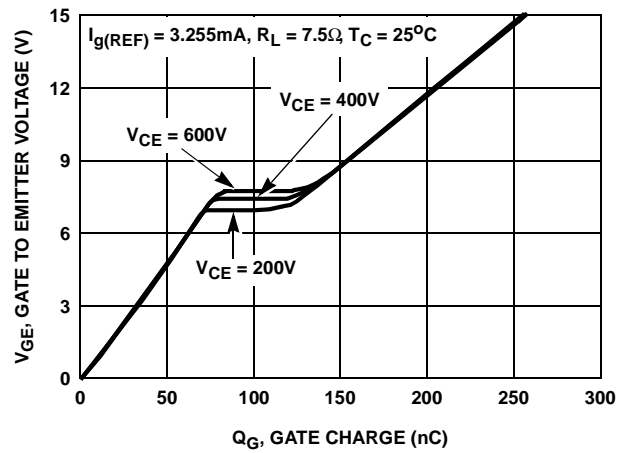

FIGURE 14. GATE CHARGE WAVEFORM

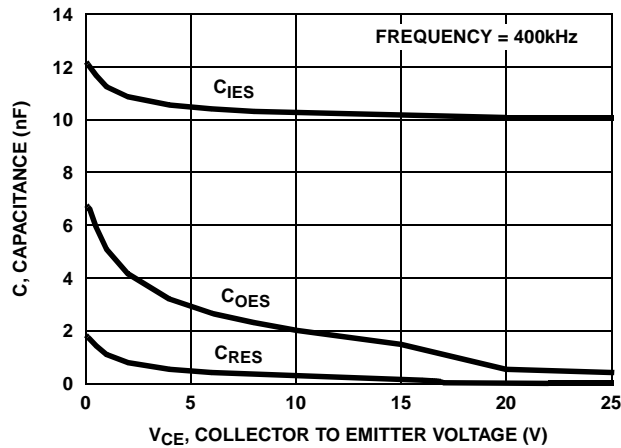

FIGURE 15. CAPACITANCE vs COLLECTOR TO EMITTER VOLTAGE

Typical Performance Curves (Unless Otherwise Specified) (Continued)

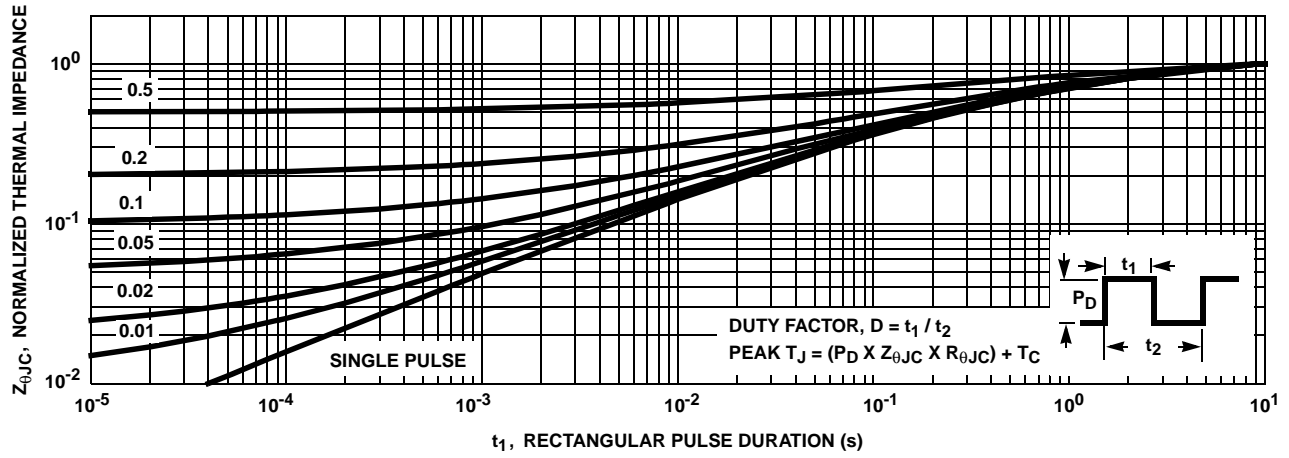

FIGURE 16. NORMALIZED TRANSIENT THERMAL RESPONSE, JUNCTION TO CASE

Test Circuit and Waveform

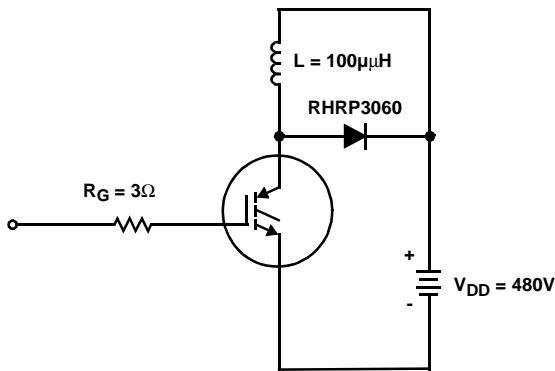

FIGURE 17. INDUCTIVE SWITCHING TEST CIRCUIT

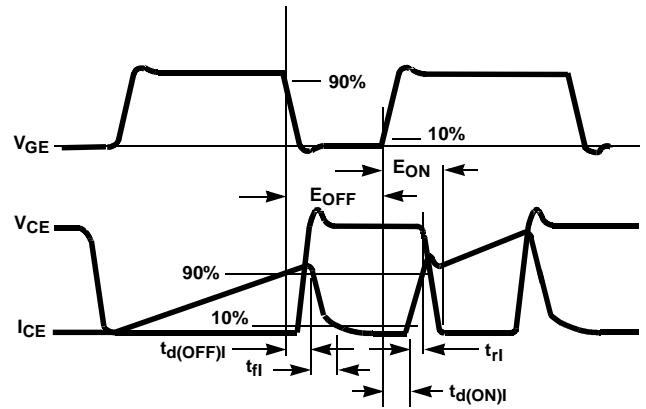

FIGURE 18. SWITCHING TEST WAVEFORM

## Handling Precautions for IGBTs

Insulated Gate Bipolar Transistors are susceptible to gate-insulation damage by the electrostatic discharge of energy through the devices. When handling these devices, care should be exercised to assure that the static charge built in the handler's body capacitance is not discharged through the device. With proper handling and application procedures, however, IGBTs are currently being extensively used in production by numerous equipment manufacturers in military, industrial and consumer applications, with virtually no damage problems due to electrostatic discharge. IGBTs can be handled safely if the following basic precautions are taken:

1. Prior to assembly into a circuit, all leads should be kept shorted together either by the use of metal shorting springs or by the insertion into conductive material such as "ECCOSORB<sup>TM</sup> LD26" or equivalent.
2. When devices are removed by hand from their carriers, the hand being used should be grounded by any suitable means - for example, with a metallic wristband.
3. Tips of soldering irons should be grounded.
4. Devices should never be inserted into or removed from circuits with power on.
5. **Gate Voltage Rating** - Never exceed the gate-voltage rating of  $V_{GEM}$ . Exceeding the rated  $V_{GE}$  can result in permanent damage to the oxide layer in the gate region.
6. **Gate Termination** - The gates of these devices are essentially capacitors. Circuits that leave the gate open-circuited or floating should be avoided. These conditions can result in turn-on of the device due to voltage buildup on the input capacitor due to leakage currents or pickup.
7. **Gate Protection** - These devices do not have an internal monolithic Zener diode from gate to emitter. If gate protection is required an external Zener is recommended.

## Operating Frequency Information

Operating frequency information for a typical device (Figure 3) is presented as a guide for estimating device performance for a specific application. Other typical frequency vs collector current ( $I_{CE}$ ) plots are possible using the information shown for a typical unit in Figures 5, 6, 7, 8, 9 and 10. The operating frequency plot (Figure 3) of a typical device shows  $f_{MAX1}$  or  $f_{MAX2}$ ; whichever is smaller at each point. The information is based on measurements of a typical device and is bounded by the maximum rated junction temperature.

$f_{MAX1}$  is defined by  $f_{MAX1} = 0.05 / (t_{d(OFF)I} + t_{d(ON)I})$ . Deadtime (the denominator) has been arbitrarily held to 10% of the on-state time for a 50% duty factor. Other definitions are possible.  $t_{d(OFF)I}$  and  $t_{d(ON)I}$  are defined in Figure 18. Device turn-off delay can establish an additional frequency limiting condition for an application other than  $T_{JM}$ .  $t_{d(OFF)I}$  is important when controlling output ripple under a lightly loaded condition.

$f_{MAX2}$  is defined by  $f_{MAX2} = (P_D - P_C) / (E_{OFF} + E_{ON})$ . The allowable dissipation ( $P_D$ ) is defined by  $P_D = (T_{JM} - T_C) / R_{\theta JC}$ . The sum of device switching and conduction losses must not exceed  $P_D$ . A 50% duty factor was used (Figure 3) and the conduction losses ( $P_C$ ) are approximated by  $P_C = (V_{CE} \times I_{CE}) / 2$ .

$E_{ON}$  and  $E_{OFF}$  are defined in the switching waveforms shown in Figure 18.  $E_{ON}$  is the integral of the instantaneous power loss ( $I_{CE} \times V_{CE}$ ) during turn-on and  $E_{OFF}$  is the integral of the instantaneous power loss ( $I_{CE} \times V_{CE}$ ) during turn-off. All tail losses are included in the calculation for  $E_{OFF}$ ; i.e., the collector current equals zero ( $I_{CE} = 0$ ).

## TRADEMARKS

The following are registered and unregistered trademarks Fairchild Semiconductor owns or is authorized to use and is not intended to be an exhaustive list of all such trademarks.

|                                      |                     |               |                     |                 |
|--------------------------------------|---------------------|---------------|---------------------|-----------------|
| ACEx™                                | FAST®               | ISOPLANAR™    | Power247™           | Stealth™        |
| ActiveArray™                         | FASTr™              | LittleFET™    | PowerEdge™          | SuperFET™       |
| Bottomless™                          | FPST™               | MICROCOUPLER™ | PowerSaver™         | SuperSOT™-3     |
| CoolFET™                             | FRFET™              | MicroFET™     | PowerTrench®        | SuperSOT™-6     |
| CROSSVOLT™                           | GlobalOptoisolator™ | MicroPak™     | QFET®               | SuperSOT™-8     |
| DOMET™                               | GTO™                | MICROWIRE™    | QS™                 | SyncFET™        |
| EcoSPARK™                            | HiSeC™              | MSX™          | QT Optoelectronics™ | TinyLogic®      |
| E <sup>2</sup> C MOS™                | ꝑC™                 | MSXPro™       | Quiet Series™       | TINYOPTO™       |
| EnSigna™                             | i-Lo™               | OCX™          | RapidConfigure™     | TruTranslation™ |
| FACT™                                | ImpliedDisconnect™  | OCXPro™       | RapidConnect™       | UHC™            |
| FACT Quiet Series™                   |                     | OPTOLOGIC®    | µSerDes™            | UltraFET®       |
| Across the board. Around the world.™ |                     | OPTOPLANAR™   | SILENT SWITCHER®    | VCX™            |
| The Power Franchise®                 |                     | PACMAN™       | SMART START™        |                 |
| Programmable Active Droop™           |                     | POP™          | SPM™                |                 |

## DISCLAIMER

FAIRCHILD SEMICONDUCTOR RESERVES THE RIGHT TO MAKE CHANGES WITHOUT FURTHER NOTICE TO ANY PRODUCTS HEREIN TO IMPROVE RELIABILITY, FUNCTION OR DESIGN. FAIRCHILD DOES NOT ASSUME ANY LIABILITY ARISING OUT OF THE APPLICATION OR USE OF ANY PRODUCT OR CIRCUIT DESCRIBED HEREIN; NEITHER DOES IT CONVEY ANY LICENSE UNDER ITS PATENT RIGHTS, NOR THE RIGHTS OF OTHERS.

## LIFE SUPPORT POLICY

FAIRCHILD'S PRODUCTS ARE NOT AUTHORIZED FOR USE AS CRITICAL COMPONENTS IN LIFE SUPPORT DEVICES OR SYSTEMS WITHOUT THE EXPRESS WRITTEN APPROVAL OF FAIRCHILD SEMICONDUCTOR CORPORATION. As used herein:

1. Life support devices or systems are devices or systems which, (a) are intended for surgical implant into the body, or (b) support or sustain life, or (c) whose failure to perform when properly used in accordance with instructions for use provided in the labeling, can be reasonably expected to result in significant injury to the user.
2. A critical component is any component of a life support device or system whose failure to perform can be reasonably expected to cause the failure of the life support device or system, or to affect its safety or effectiveness.

## PRODUCT STATUS DEFINITIONS

### Definition of Terms

| Datasheet Identification | Product Status         | Definition  |
|--------------------------|------------------------|---|
| Advance Information      | Formative or In Design | This datasheet contains the design specifications for product development. Specifications may change in any manner without notice.  |
| Preliminary              | First Production       | This datasheet contains preliminary data, and supplementary data will be published at a later date. Fairchild Semiconductor reserves the right to make changes at any time without notice in order to improve design. |
| No Identification Needed | Full Production        | This datasheet contains final specifications. Fairchild Semiconductor reserves the right to make changes at any time without notice in order to improve design.   |
| Obsolete                 | Not In Production      | This datasheet contains specifications on a product that has been discontinued by Fairchild semiconductor. The datasheet is printed for reference information only.   |