

ILC7062

SOT-23 CMOS LDO

Features

- Low Power Consumption: typ 2.0 μ A at $V_{OUT} = 5V$
- All-CMOS design in SOT-23 and SOT-89 packages gives optimal size and power performances.
- Highly accurate output $\pm 2\%$ ($\pm 1\%$)
- Maximum output current: 250mA (Limited to 150mW power dissipation SOT-23, 500mW SOT-89)
- Output Voltage Range: 2.0V to 6.0V

Applications

- Battery-powered Equipment
- Reference voltage sources
- Palmtops
- Portable cameras and video recorders

Description

250mA CMOS LDO in a SOT-23 package, featuring 120mV of dropout voltage at 100mA and 380mV at 200mA current levels.

The part offers $\pm 2\%$ accuracy on outputs, yet draws only 2 μ A of current. Short-circuit protection is standard.

The part comes in both 3-lead SOT-23 (150mW) and 3-lead SOT-89 (500mW) to handle a variety of voltage and current levels.

Transient response to load variations have improved in comparison to the existing series.

Low Power consumption and high accuracy is achieved through CMOS and laser trimming technologies.

Typical Applications

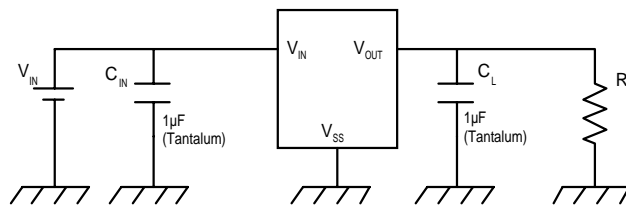

Pin Assignments

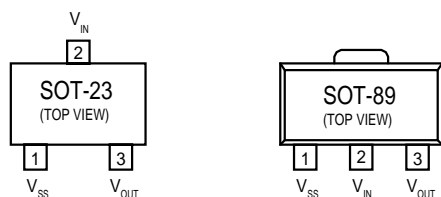

Internal Block Diagram

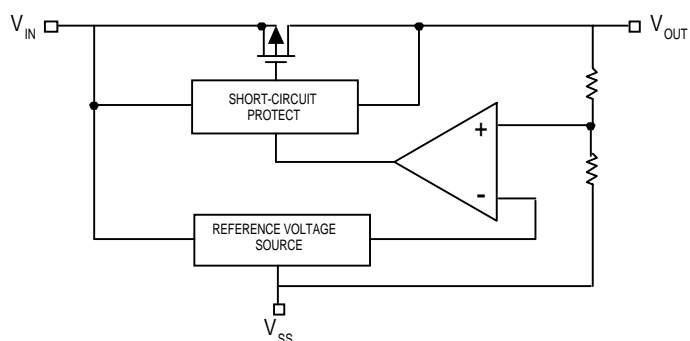

Absolute Maximum Ratings

Parameter	Symbol	Ratings	Units	
Input Voltage	V_{IN}	12	V	
Output Current (Note 3)	I_{OUTmax}	500	mA	
Output Voltage (Note 1)	V_{OUT}	$V_{SS}-0.3 \sim V_{IN}+0.3$	V	
Continuous Total Power Dissipation	SOT-23	P_D	150	mW
	SOT-89		500	
Operating Ambient Temperature	T_{opr}	-40~+85	°C	
Storage Temperature	T_{stg}	-40~+125	°C	

Electrical Characteristics ILC7062CP-50

$T_A = 25^\circ\text{C}$

Parameter	Symbol	Conditions	Min.	Typ.	Max.	Units
Output Voltage	V_{OUT}	$I_{OUT} = 40\text{mA}$, $V_{IN} = 6.0\text{V}$	4.90	5.0	5.10	V
Maximum Output Current	I_{OUTmax}	$V_{IN} = 6.0\text{V}$, $V_{OUT} \geq 4.5\text{V}$	250			mA
Load Stability	ΔV_{OUT}	Conditions		40	80	mV
Input/Output Voltage Differential (Note 2)	V_{dif}	$I_{OUT} = 100\text{mA}$ $I_{OUT} = 200\text{mA}$		120 380	300 600	mV
Supply Current	I_{SS}	$V_{IN} = 6.0\text{V}$		2	4.5	μA
Input Stability	$\frac{\Delta V_{OUT}}{\Delta V_{IN} \cdot V_{OUT}}$	$I_{OUT} = 40\text{mA}$ $6.0\text{V} \leq V_{IN} \leq 10.0\text{V}$		0.2	0.3	%/V
Input Voltage	V_{IN}				10.0	V
Output Voltage Temperature Characteristics	$\frac{\Delta V_{OUT}}{\Delta T_{opr} \cdot V_{OUT}}$	$I_{OUT} = 40\text{mA}$ $-40^\circ\text{C} \leq T_{opr} \leq 85^\circ\text{C}$		± 100		ppm/ $^\circ\text{C}$

Notes:

- V_{OUT} means the output voltage when " $V_{OUT} + 1.0\text{V}$ " is provided at the V_{IN} pin while maintaining a certain I_{OUT} value.
- V_{dif} is defined as " $V_{IN} - V_{OUT}$ " where $V_{OUT} = V_{SET} \times 0.98$.
- I_{OUTmax} = This is specified for SOT-89 package. For SOT-23, it is limited by continuous total power dissipation.

Electrical Characteristics ILC7062CP-33

$T_A = ^\circ\text{C}$

Parameter	Symbol	Conditions	Min.	Typ.	Max.	Units
Output Voltage	V_{OUT}	$I_{OUT} = 40\text{mA}$, $V_{IN} = 4.3\text{V}$	3.234	3.300	3.366	V
Maximum Output Current	I_{OUTmax}	$V_{IN} = 4.3\text{V}$, $V_{OUT} \geq 2.97\text{V}$	50			mA
Load Stability	ΔV_{OUT}	$V_{IN} = 4.3\text{V}$, $1\text{mA} \leq I_{OUT} \leq 80\text{mA}$		45	90	mV
Input/Output Voltage Differential (Note 2)	V_{dif}	$I_{OUT} = 80\text{mA}$ $I_{OUT} = 160\text{mA}$		180 400	360 700	mV
Supply Current	I_{SS}	$V_{IN} = 4.0\text{V}$		2	4.5	μA
Input Stability	$\frac{\Delta V_{OUT}}{\Delta V_{IN} \cdot V_{OUT}}$	$I_{OUT} = 40\text{mA}$ $4.3\text{V} \leq V_{IN} \leq 10.0\text{V}$		0.2	0.3	%/V
Input Voltage	V_{IN}				10.0	V
Output Voltage Temperature Characteristics	$\frac{\Delta V_{OUT}}{\Delta T_{opr} \cdot V_{OUT}}$	$I_{OUT} = 40\text{mA}$ $-30^\circ\text{C} \leq T_{opr} \leq 80^\circ\text{C}$		± 100		ppm/ $^\circ\text{C}$

Electrical Characteristics ILC7062CP-30

$T_A = 25^\circ\text{C}$

Parameter	Symbol	Conditions	Min.	Typ.	Max.	Units
Output Voltage	V_{OUT}	$I_{OUT} = 40\text{mA}$, $V_{IN} = 4.0\text{V}$	2.94	3.0	3.06	V
Maximum Output Current	I_{OUTmax}	$V_{IN} = 4.0\text{V}$, $V_{OUT} \geq 2.7\text{V}$	150			mA
Load Stability	ΔV_{OUT}	$V_{IN} = 4.0\text{V}$, $1\text{mA} \leq I_{OUT} \leq 80\text{mA}$		45	90	mV
Input/Output Voltage Differential (Note 2)	V_{dif}	$I_{OUT} = 80\text{mA}$ $I_{OUT} = 160\text{mA}$		180 400	360 700	mV
Supply Current	I_{SS}	$V_{IN} = 4.0\text{V}$		2	4.5	μA
Input Stability	$\frac{\Delta V_{OUT}}{\Delta V_{IN} \cdot \Delta V_{OUT}}$	$I_{OUT} = 40\text{mA}$ $4.0\text{V} \leq V_{IN} \leq 10.0\text{V}$		0.2	0.3	%/V
Input Voltage	V_{IN}				10.0	V
Output Voltage Temperature Characteristics	$\frac{\Delta V_{OUT}}{\Delta T_{opr} \cdot V_{OUT}}$	$I_{OUT} = 40\text{mA}$ $-30^\circ\text{C} \leq T_{opr} \leq 80^\circ\text{C}$		± 100		ppm/ $^\circ\text{C}$

Notes:

- V_{OUT} means the output voltage when " $V_{OUT} + 1.0\text{V}$ " is provided at the V_{IN} pin while maintaining a certain I_{OUT} value.
- V_{dif} is defined as " $V_{IN} - V_{OUT}$ " where $V_{OUT} = V_{SET} \times 0.98$.
- I_{OUTmax} = This is specified for SOT-89 package. For SOT-23, it is limited by continuous total power dissipation.

Typical Performance Characteristics General conditions for all curves

Output Voltage vs Output Current

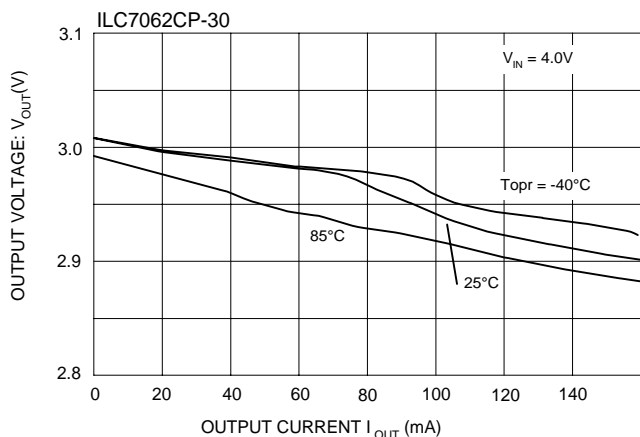

V_{DO} vs Output Current

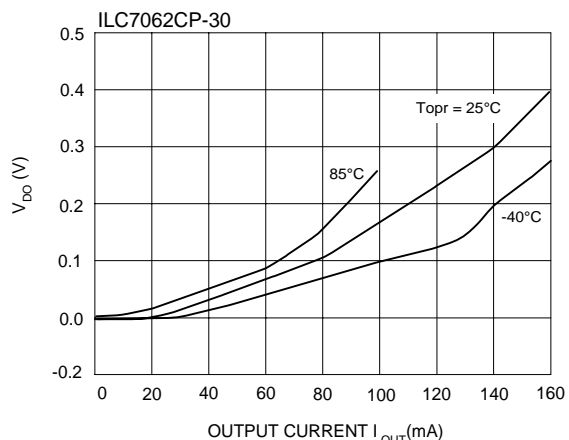

Output Voltage vs Input Voltage

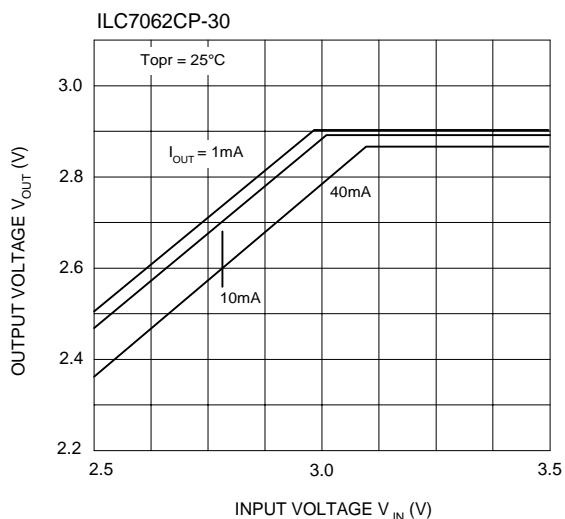

Output Voltage vs Output Current

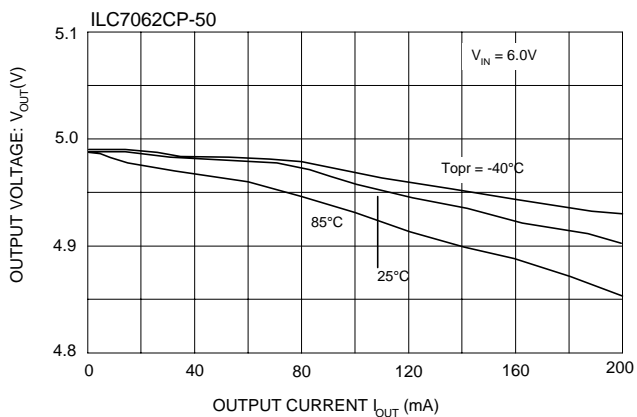

Output Voltage vs Input Voltage

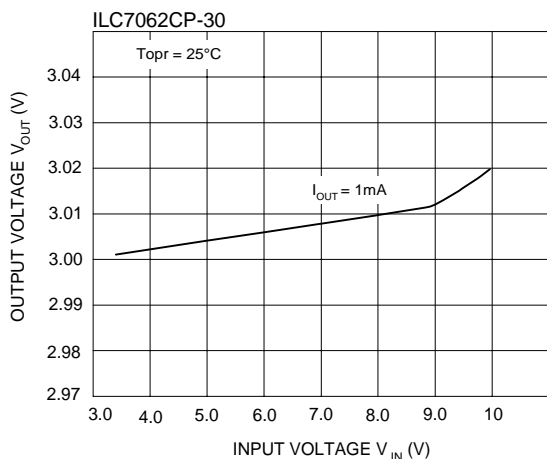

Output Voltage vs Input Voltage

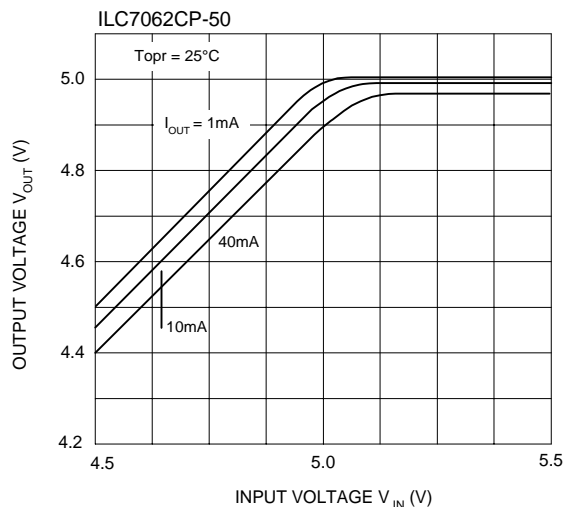

Typical Performance Characteristics General conditions for all curves

Output Voltage vs Input Voltage

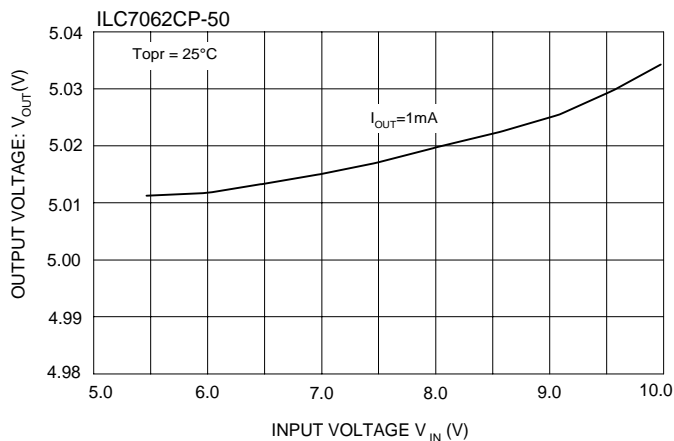

I_{DD} vs Input Voltage

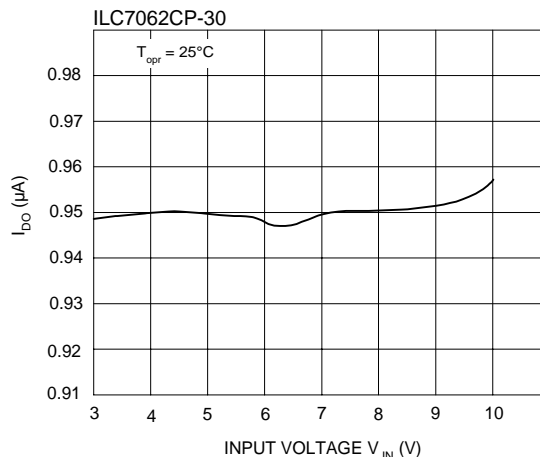

V_{DD} vs Output Current

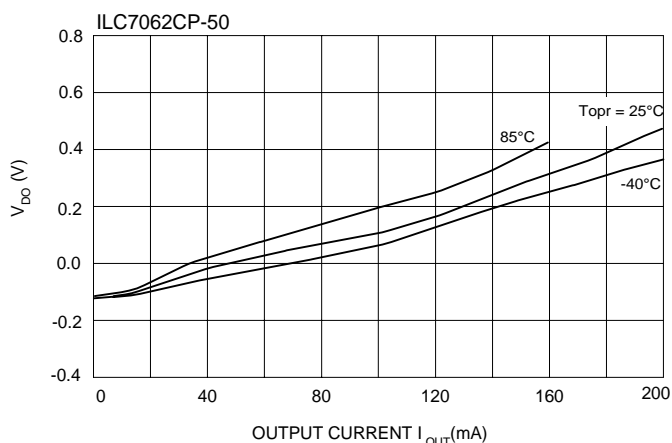

I_{DD} vs T_{opr}

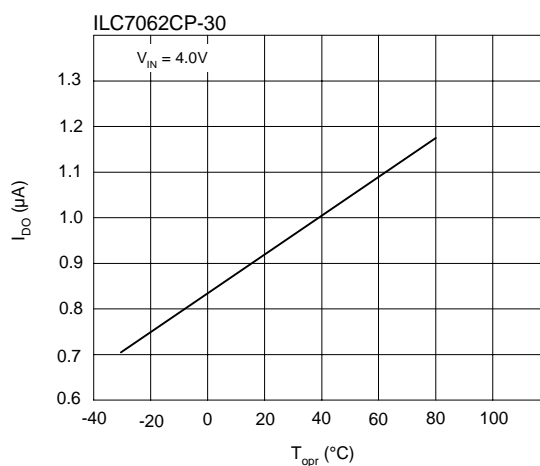

Output Voltage vs Temperature

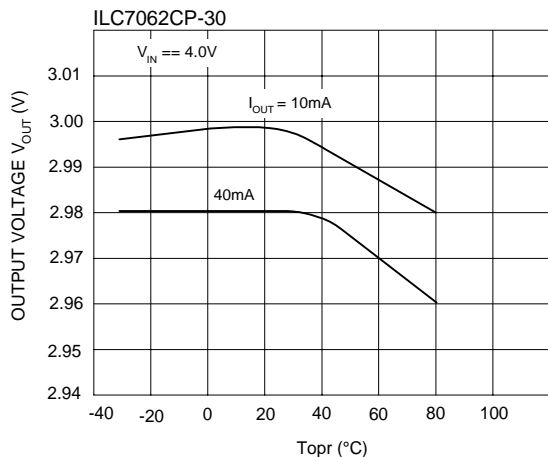

Output Voltage vs Temperature

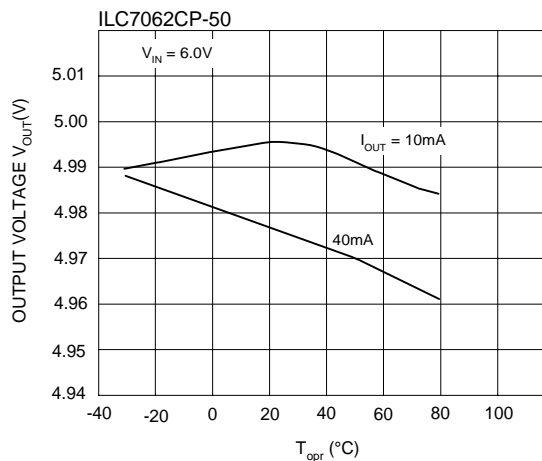

Typical Performance Characteristics General conditions for all curves

I_{DD} vs Input Voltage

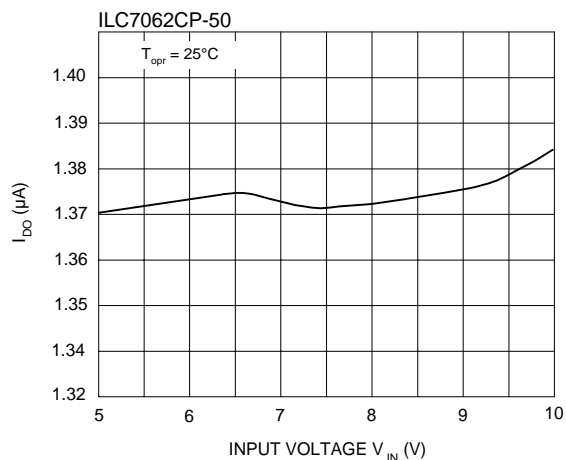

I_{DD} vs T_{opr}

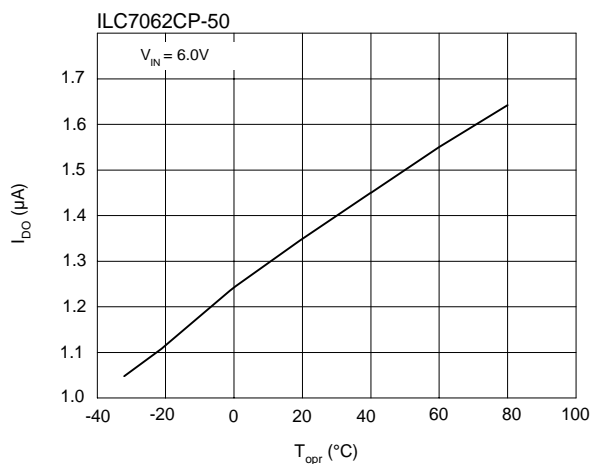

Line Transient Response

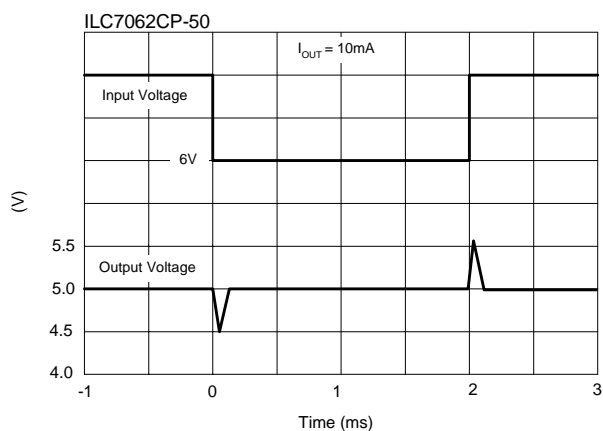

Load Transient Response

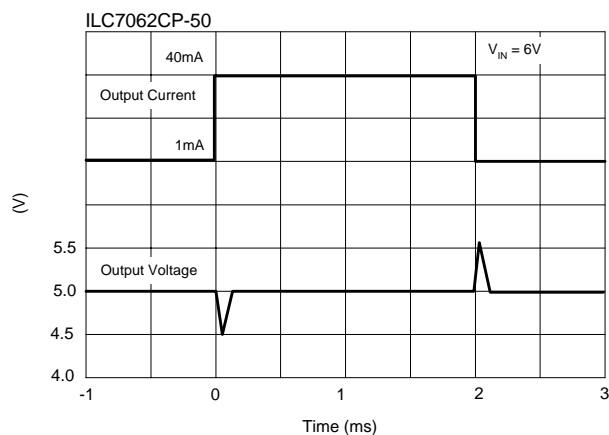

Ripple Rejection Rate

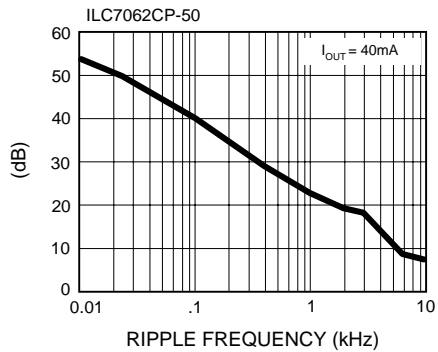

Ripple Rejection Rate

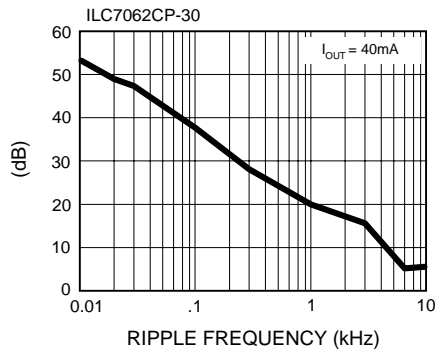

Ordering Information	
ILC7062CP-50	5.0V output, SOT-89*
ILC7062CM-50	5.0V output, SOT-23-3**
ILC7062CP-46	4.6V output, SOT-89*
ILC7062CP-33	3.3V output, SOT-89*
ILC7062CP-30	3.0V output, SOT-89*
ILC7062CP-25	2.5V output, SOT-89*
ILC7062CM-25	2.5V output, SOT-23-3**
	*Max power dissipation of 500mW **Max power dissipation of 150mW

*Standard product offering comes in tape & reel, quantity 3000 per reel, orientation right for SOT-23, quantity 1000 per reel, orientation right for SOT-89

DISCLAIMER

FAIRCHILD SEMICONDUCTOR RESERVES THE RIGHT TO MAKE CHANGES WITHOUT FURTHER NOTICE TO ANY PRODUCTS HEREIN TO IMPROVE RELIABILITY, FUNCTION OR DESIGN. FAIRCHILD DOES NOT ASSUME ANY LIABILITY ARISING OUT OF THE APPLICATION OR USE OF ANY PRODUCT OR CIRCUIT DESCRIBED HEREIN; NEITHER DOES IT CONVEY ANY LICENSE UNDER ITS PATENT RIGHTS, NOR THE RIGHTS OF OTHERS.

LIFE SUPPORT POLICY

FAIRCHILD'S PRODUCTS ARE NOT AUTHORIZED FOR USE AS CRITICAL COMPONENTS IN LIFE SUPPORT DEVICES OR SYSTEMS WITHOUT THE EXPRESS WRITTEN APPROVAL OF THE PRESIDENT OF FAIRCHILD SEMICONDUCTOR CORPORATION. As used herein:

1. Life support devices or systems are devices or systems which, (a) are intended for surgical implant into the body, or (b) support or sustain life, and (c) whose failure to perform when properly used in accordance with instructions for use provided in the labeling, can be reasonably expected to result in a significant injury of the user.
2. A critical component in any component of a life support device or system whose failure to perform can be reasonably expected to cause the failure of the life support device or system, or to affect its safety or effectiveness.