



IRF350-353
N-channel Power MOSFETs,
15 A, 350 V/400 V

T-39-13

Power And Discrete Division

Description

These devices are n-channel, enhancement mode, power MOSFETs designed especially for high voltage, high speed applications, such as off-line switching power supplies, UPS, AC and DC motor controls, relay and solenoid drivers.

TO-204AA

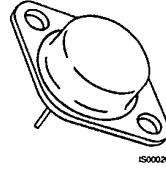

- V_{GS} Rated at ± 20 V
- Silicon Gate for Fast Switching Speeds
- I_{DSS} , $V_{DS(on)}$, SOA and $V_{GS(th)}$ Specified at Elevated Temperature
- Rugged

IRF350
 IRF351
 IRF352
 IRF353

2

Maximum Ratings

Symbol	Characteristic	Rating IRF350/352	Rating IRF351/353	Unit
V_{DSS}	Drain to Source Voltage	400	350	V
V_{DGR}	Drain to Gate Voltage $R_{GS} = 1.0 \text{ M}\Omega$	400	350	V
V_{GS}	Gate to Source Voltage	± 20	± 20	V
T_J, T_{stg}	Operating Junction and Storage Temperatures	-55 to +150	-55 to +150	$^{\circ}\text{C}$
T_L	Maximum Lead Temperature for Soldering Purposes, 1/8" From Case for 5 s	275	275	$^{\circ}\text{C}$

Maximum On-State Characteristics

		IRF350/351	IRF352/353	
$R_{DS(on)}$	Static Drain-to-Source On Resistance	0.3	0.4	Ω
I_D	Drain Current			A
	Continuous	15	13	
	Pulsed	60	52	

Maximum Thermal Characteristics

$R_{\theta JC}$	Thermal Resistance, Junction to Case	0.83	0.83	$^{\circ}\text{C}/\text{W}$
P_D	Total Power Dissipation at $T_C = 25^{\circ}\text{C}$	150	150	W

Notes
 For information concerning connection diagram and package outline, refer to Section 7.

IRF350-353

T-39-13

Electrical Characteristics ($T_C = 25^\circ\text{C}$ unless otherwise noted)

Symbol	Characteristic	Min	Max	Unit	Test Conditions
Off Characteristics					
$V_{(BR)DSS}$	Drain Source Breakdown Voltage ¹			V	$V_{GS} = 0\text{ V}$, $I_D = 250\ \mu\text{A}$
	IRF350/352	400			
	IRF351/353	350			
I_{DSS}	Zero Gate Voltage Drain Current		250	μA	$V_{DS} = \text{Rated } V_{DSS}$, $V_{GS} = 0\text{ V}$
			1000	μA	$V_{DS} = 0.8 \times \text{Rated } V_{DSS}$, $V_{GS} = 0\text{ V}$, $T_C = 125^\circ\text{C}$
I_{GSS}	Gate-Body Leakage Current		± 100	nA	$V_{GS} = \pm 20\text{ V}$, $V_{DS} = 0\text{ V}$
On Characteristics					
$V_{GS(th)}$	Gate Threshold Voltage	2.0	4.0	V	$I_D = 250\ \mu\text{A}$, $V_{DS} = V_{GS}$
$R_{DS(on)}$	Static Drain-Source On-Resistance ²			Ω	$V_{GS} = 10\text{ V}$, $I_D = 8.0\text{ A}$
	IRF350/351		0.3		
	IRF352/353		0.4		
g_{fs}	Forward Transconductance	8.0		S (Ω)	$V_{DS} = 10\text{ V}$, $I_D = 8.0\text{ A}$
Dynamic Characteristics					
C_{iss}	Input Capacitance		3000	pF	$V_{DS} = 25\text{ V}$, $V_{GS} = 0\text{ V}$ $f = 1.0\text{ MHz}$
C_{oss}	Output Capacitance		600	pF	
C_{rss}	Reverse Transfer Capacitance		200	pF	
Switching Characteristics ($T_C = 25^\circ\text{C}$, Figures 9, 10)					
$t_{d(on)}$	Turn-On Delay Time		35	ns	$V_{DD} = 180\text{ V}$, $I_D = 8.0\text{ A}$ $V_{GS} = 10\text{ V}$, $R_{GEN} = 4.7\ \Omega$ $R_{GS} = 4.7\ \Omega$
t_r	Rise Time		65	ns	
$t_{d(off)}$	Turn-Off Delay Time		150	ns	
t_f	Fall Time		75	ns	
Q_g	Total Gate Charge		120	nC	$V_{GS} = 10\text{ V}$, $I_D = 16\text{ A}$ $V_{DD} = 400\text{ V}$
Symbol Characteristic Typ Max Unit Test Conditions					
Source-Drain Diode Characteristics					
V_{SD}	Diode Forward Voltage			V	$I_S = 15\text{ A}$; $V_{GS} = 0\text{ V}$
	IRF350/351		1.6	V	
	IRF352/353		1.5	V	$I_S = 13\text{ A}$; $V_{GS} = 0\text{ V}$
t_{rr}	Reverse Recovery Time	600		ns	$I_S = 15\text{ A}$; $di_S/dt = 100\text{ A}/\mu\text{S}$

Notes

- $T_J = +25^\circ\text{C}$ to $+150^\circ\text{C}$
- Pulse test: Pulse width $\leq 80\ \mu\text{s}$, Duty cycle $\leq 1\%$

IRF350-353

T-39-13

Typical Performance Curves

Figure 1 Output Characteristics

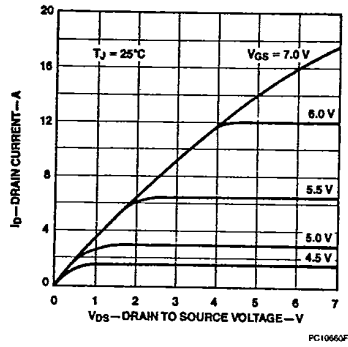

Figure 2 Static Drain to Source On Resistance vs Drain Current

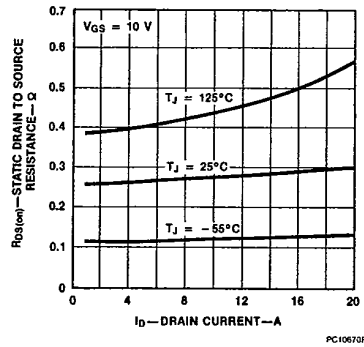

Figure 3 Transfer Characteristics

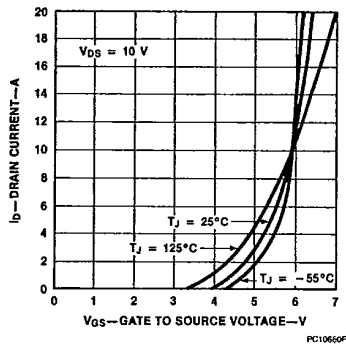

Figure 4 Temperature Variation of Gate to Source Threshold Voltage

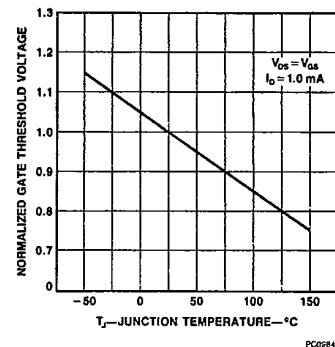

Figure 5 Capacitance vs Drain to Source Voltage

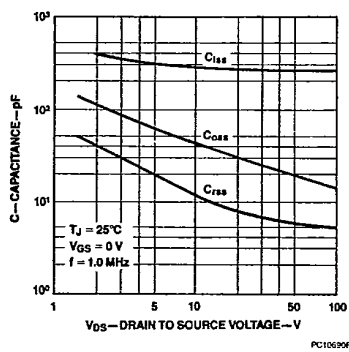
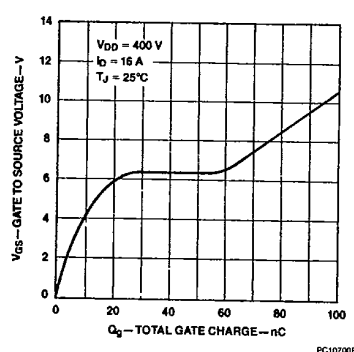

Figure 6 Gate to Source Voltage vs Total Gate Charge



IRF350-353

T-39-13

Typical Performance Curves (Cont.)

Figure 7 Forward Biased Safe Operating Area

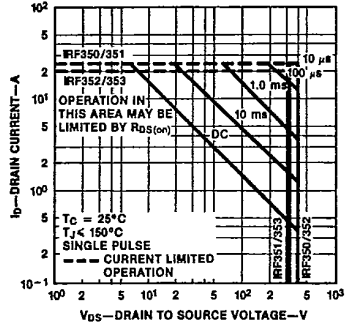
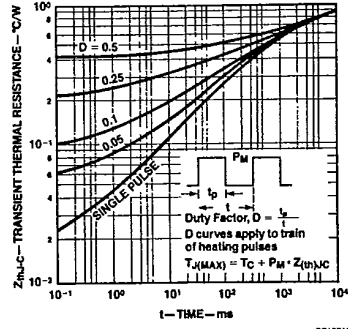

Figure 8 Transient Thermal Resistance vs Time



Typical Electrical Characteristics

Figure 9 Switching Test Circuit

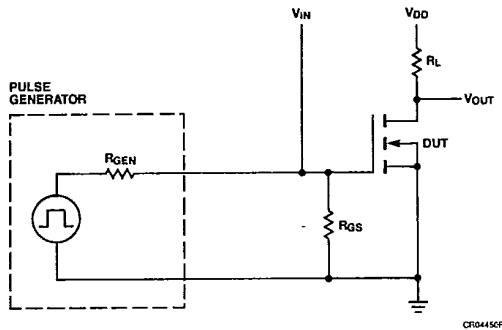

Figure 10 Switching Waveforms

