

# KM4112

## 70 $\mu$ A, Low Cost, +2.7V & +5V, 7.3MHz Rail-to-Rail Amplifier

### Features

- 70 $\mu$ A supply current
- 7.3MHz bandwidth
- Fully specified at +2.7V and +5V supplies
- Output voltage range: 0.04V to 4.96V;  $V_S = +5$
- Input voltage range: -0.3V to +3.8V;  $V_S = +5$
- 9V/ $\mu$ s slew rate
- $\pm 4$ mA linear output current
- $\pm 9$ mA short circuit output current
- 29nV/ $\sqrt{\text{Hz}}$  input voltage noise
- Competes with low power CMOS amps
- Small package option (SOT23-5)

### Applications

- Portable/battery-powered applications
- A/D buffer
- Active filters
- Signal conditioning
- Portable test instruments

### KM4112 Package

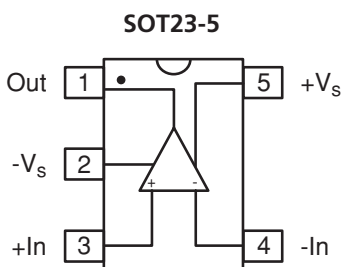

### General Description

The KM4112 is an ultra-low power, low cost, voltage feedback amplifier. The KM4112 uses only 70 $\mu$ A of supply current and is designed to operate on +2.7V, +5V, or  $\pm 2.5$ V supplies. The input voltage range extends 300mV below the negative rail and 1.2V below the positive rail.

The KM4112 offers high bipolar performance at a low CMOS price. The KM4112 offers superior dynamic performance with a 7.3MHz small signal bandwidth and 9V/ $\mu$ s slew rate. The combination of low power, high bandwidth, and rail-to-rail performance make the KM4112 well suited for battery-powered communication/computing systems.

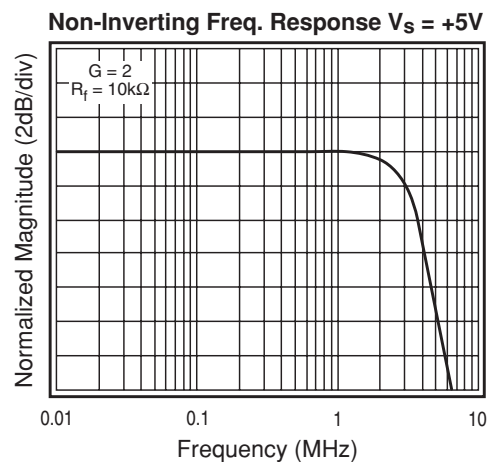

## KM4112 Electrical Characteristics ( $V_s = +2.7V$ , $G = 2$ , $R_L = 10k\Omega$ to $V_s/2$ , $R_f = 10k\Omega$ ; unless noted)

PARAMETERS	CONDITIONS	TYP	MIN & MAX	UNITS	NOTES
Case Temperature		+25°C	+25°C		
<b>Frequency Domain Response</b>					
-3dB bandwidth	$G = +1, V_O = 0.05V_{pp}$	6.5		MHz	1
full power bandwidth	$G = +2, V_O < 0.2V_{pp}$	3		MHz	
gain bandwidth product	$G = -1, V_O = 2V_{pp}$	2		MHz	
		3.5		MHz	
<b>Time Domain Response</b>					
rise and fall time	0.2V step	55		ns	
settling time to 0.1%	1V step	700		ns	
overshoot	1V step,	7		%	
slew rate	2V step, $G = -1$	7		V/ $\mu$ s	
<b>Distortion and Noise Response</b>					
2nd harmonic distortion	$1V_{pp}, 100kHz$	68		dBc	
3rd harmonic distortion	$1V_{pp}, 100kHz$	65		dBc	
THD	$1V_{pp}, 100kHz$	63		dB	
input voltage noise	>10kHz	30		nV/ $\sqrt{Hz}$	
<b>DC Performance</b>					
input offset voltage		1	$\pm 5$	mV	2
average drift		3		$\mu$ V/ $^{\circ}$ C	
input bias current		90	250	nA	2
average drift		100		pA/ $^{\circ}$ C	
input offset current		2.1	100	nA	2
power supply rejection ratio	DC	63	58	dB	2
open loop gain		82	65	dB	2
quiescent current		62	95	$\mu$ A	2
<b>Input Characteristics</b>					
input resistance		>10		M $\Omega$	
input capacitance		1.6		pF	
input common mode voltage range		-0.3 to 1.5		V	
common mode rejection ratio	DC, $V_{cm} = 0V$ to $V_s - 1.5$	95	68	dB	2
<b>Output Characteristics</b>					
output voltage swing	$R_L = 10k\Omega$ to $V_s/2$	0.035 to 2.665	0.15 to 2.55	V	2
	$R_L = 2k\Omega$ to $V_s/2$	0.07 to 2.6		V	
linear output current		$\pm 4$		mA	
short circuit output current		$\pm 9$		mA	
power supply operating range		2.7	2.5 to 5.5	V	

Min/max ratings are based on product characterization and simulation. Individual parameters are tested as noted. Outgoing quality levels are determined from tested parameters.

### NOTES:

- 1) For  $G = +1$ ,  $R_f = 0$ .
- 2) 100% tested at +25°C.

## Absolute Maximum Ratings

supply voltage	0 to +6V
maximum junction temperature	+175°C
storage temperature range	-65°C to +150°C
lead temperature (10 sec)	+260°C
operating temperature range (recommended)	-40°C to +85°C
input voltage range	+ $V_s$ +0.5V; - $V_s$ -0.5V
internal power dissipation	see power derating curves

## Package Thermal Resistance

Package	$\theta_{JA}$
5 lead SOT23	256°C/W

## KM4112 Electrical Characteristics ( $V_s = +5V$ , $G = 2$ , $R_L = 10k\Omega$ to $V_s/2$ , $R_f = 10k\Omega$ ; unless noted)

PARAMETERS	CONDITIONS	TYP	MIN & MAX	UNITS	NOTES
Case Temperature		+25°C	+25°C		
<b>Frequency Domain Response</b>					
-3dB bandwidth	$G = +1, V_O = 0.05V_{pp}$	7.3		MHz	1
full power bandwidth	$G = +2, V_O < 0.2V_{pp}$	3.4		MHz	
gain bandwidth product	$G = -1, V_O = 2V_{pp}$	2.5		MHz	
		4		MHz	
<b>Time Domain Response</b>					
rise and fall time	0.2V step	50		ns	
settling time to 0.1%	2V step	600		ns	
overshoot	2V step,	4		%	
slew rate	2V step, $G = -1$	9		V/ $\mu$ s	
<b>Distortion and Noise Response</b>					
2nd harmonic distortion	$2V_{pp}, 100kHz$	67		dBc	
3rd harmonic distortion	$2V_{pp}, 100kHz$	56		dBc	
THD	$2V_{pp}, 100kHz$	55		dB	
input voltage noise	>10kHz	29		nV/ $\sqrt{Hz}$	
<b>DC Performance</b>					
input offset voltage		1	$\pm 5$	mV	2
average drift		8		$\mu$ V/ $^{\circ}C$	
input bias current		90	250	nA	2
average drift		100		pA/ $^{\circ}C$	
input offset current		1.3	100	nA	2
power supply rejection ratio	DC	63	58	dB	2
open loop gain		76	65	dB	2
quiescent current		70	100	$\mu$ A	2
<b>Input Characteristics</b>					
input resistance		>10		M $\Omega$	
input capacitance		1.6		pF	
input common mode voltage range		-0.3 to 3.8		V	
common mode rejection ratio	DC, $V_{cm} = 0V$ to $V_s - 1.5$	97	68	dB	2
<b>Output Characteristics</b>					
output voltage swing	$R_L = 10k\Omega$ to $V_s/2$	0.04 to 4.96	0.15 to 4.85	V	2
	$R_L = 2k\Omega$ to $V_s/2$	0.09 to 4.9		V	
linear output current		$\pm 4$		mA	
short circuit output current		$\pm 9$		mA	
power supply operating range		5	2.5 to 5.5	V	

Min/max ratings are based on product characterization and simulation. Individual parameters are tested as noted. Outgoing quality levels are determined from tested parameters.

### NOTES:

- 1) For  $G = +1$ ,  $R_f = 0$ .
- 2) 100% tested at +25°C.

**KM4112 Performance Characteristics** ( $V_s = +5V$ ,  $G = 2$ ,  $R_L = 10k\Omega$  to  $V_s/2$ ,  $R_f = 10k\Omega$ ; unless noted)

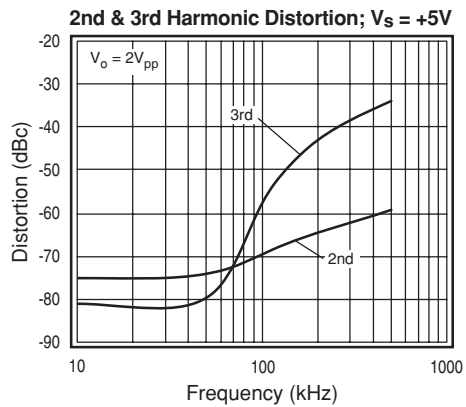
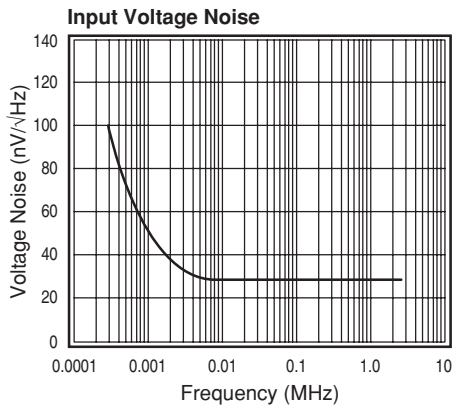
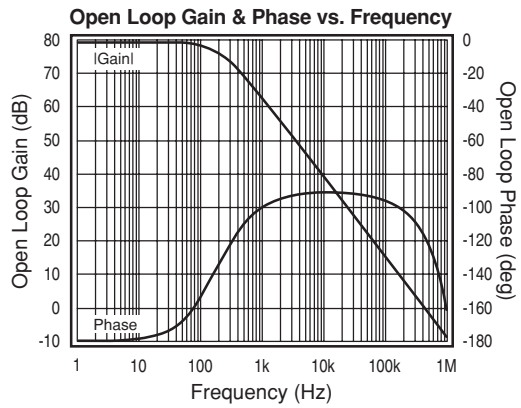
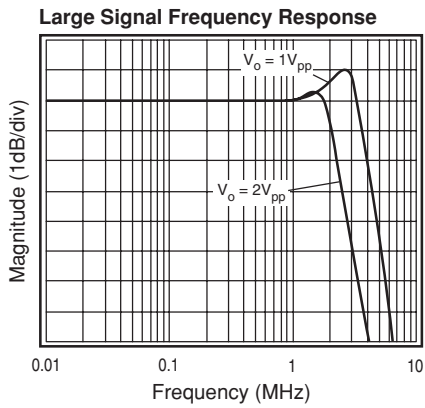
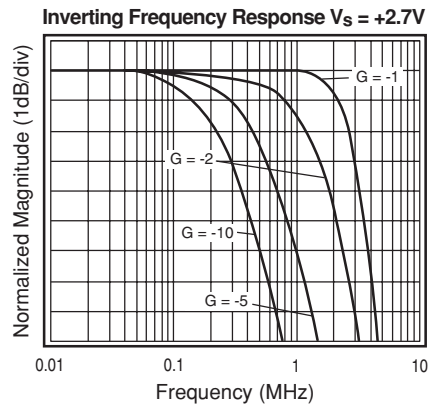
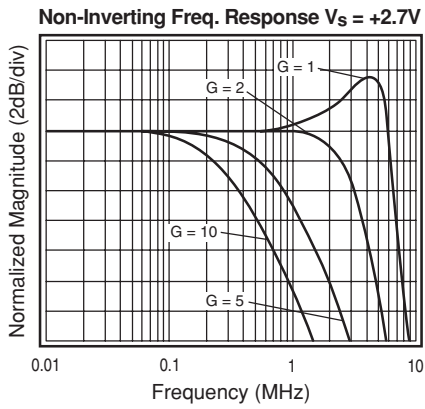
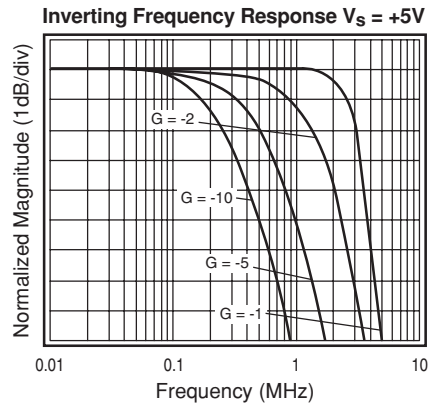
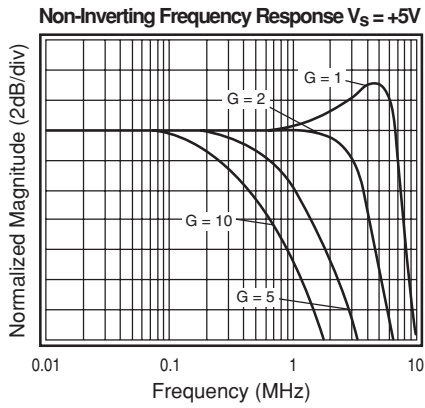

**KM4112 Performance Characteristics** ( $V_s = +5V$ ,  $G = 2$ ,  $R_L = 10k\Omega$  to  $V_s/2$ ,  $R_f = 10k\Omega$ ; unless noted)

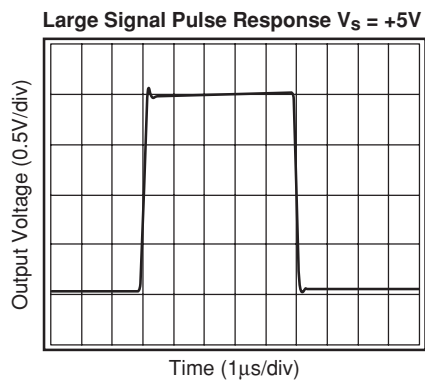
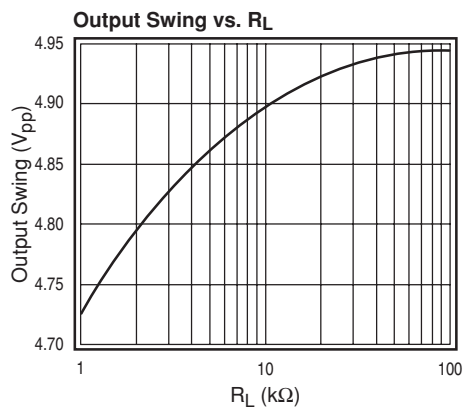
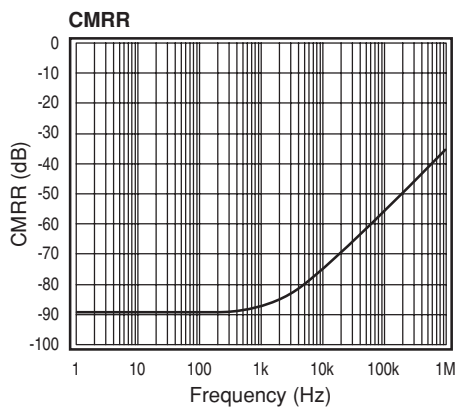
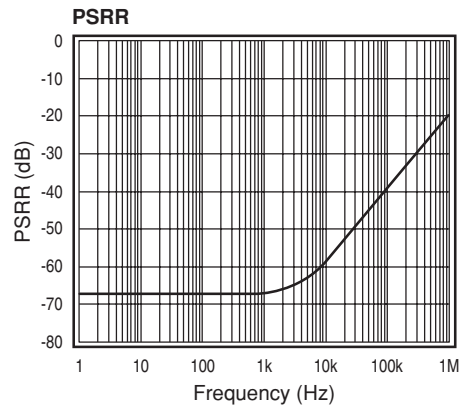
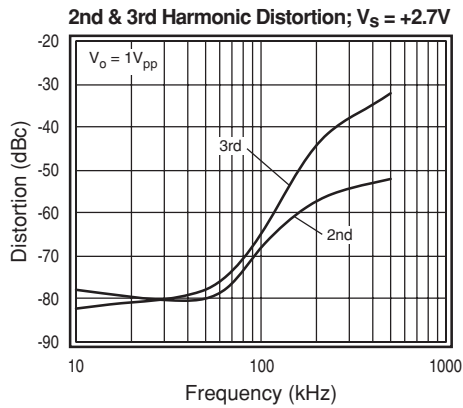

**General Description**

The KM4112 is a single supply, general purpose, voltage-feedback amplifier fabricated on a complementary bipolar process. The KM4112 offers 7.3MHz unity gain bandwidth, 9V/μs slew rate, and only 70μA supply current. It features a rail-to-rail output stage and is unity gain stable.

The design utilizes a patent pending topology that provides increased slew rate performance. The common mode input range extends to 300mV below ground and to 1.2V below  $V_S$ . Exceeding these values will not cause phase reversal. However, if the input voltage exceeds the rails by more than 0.5V, the input ESD devices will begin to conduct. The output will stay at the rail during this overdrive condition.

The design uses a Darlington output stage. The output stage is short circuit protected and offers "soft" saturation protection that improves recovery time.

The typical circuit schematic is shown in Figure 1.

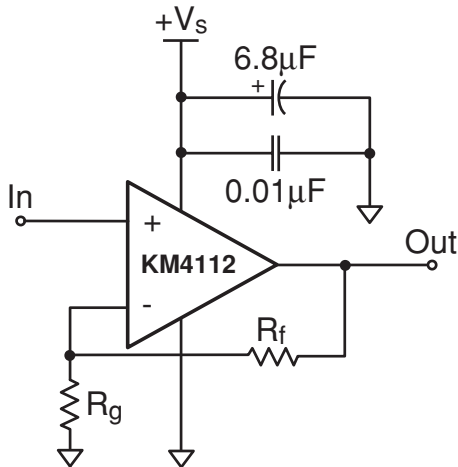
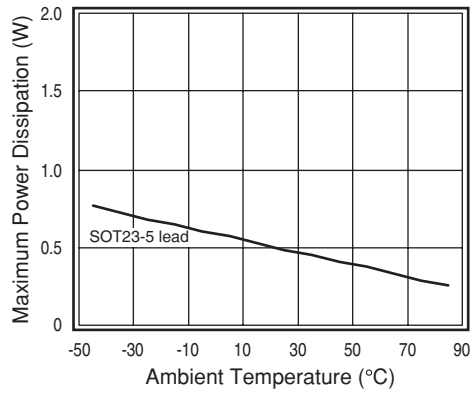

**Figure 1: Typical Configuration**

**Power Dissipation**

The maximum internal power dissipation allowed is directly related to the maximum junction temperature. If the maximum junction temperature exceeds 150°C, some reliability degradation will occur. If the maximum junction temperature exceeds 175°C for an extended time, device failure may occur.

The KM4112 is short circuit protected. However, this may not guarantee that the maximum junction temperature (+150°C) is not exceeded under all conditions. Follow the maximum power derating curves shown in Figure 2 to ensure proper operation.



**Figure 2: Power Derating Curves**

**Overdrive Recovery**

For an amplifier, an overdrive condition occurs when the output and/or input ranges are exceeded. The recovery time varies based on whether the input or output is overdriven and by how much the ranges are exceeded. The KM4112 will typically recover in less than 60ns from an overdrive condition. Figure 3 shows the KM4112 in an overdriven condition.

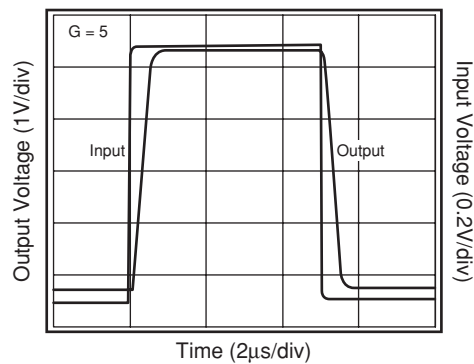

**Figure 3: Overdrive Recovery**

**Driving Capacitive Loads**

A small series resistance ( $R_S$ ) at the output of the amplifier, illustrated in Figure 4, will improve stability and settling performance.

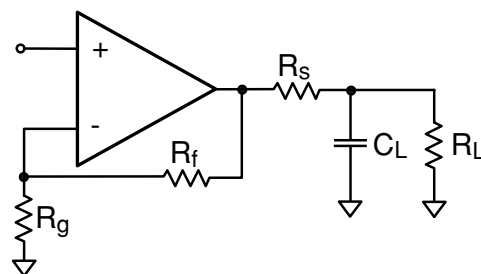

**Figure 4: Typical Topology for driving a capacitive load**

### Layout Considerations

General layout and supply bypassing play major roles in high frequency performance. Fairchild has evaluation boards to use as a guide for high frequency layout and to aid in device testing and characterization. Follow the steps below as a basis for high frequency layout:

- Include 6.8 $\mu$ F and 0.01 $\mu$ F ceramic capacitors
- Place the 6.8 $\mu$ F capacitor within 0.75 inches of the power pin
- Place the 0.01 $\mu$ F capacitor within 0.1 inches of the power pin
- Remove the ground plane under and around the part, especially near the input and output pins to reduce parasitic capacitance
- Minimize all trace lengths to reduce series inductances

Refer to the evaluation board layouts shown in Figure 6 for more information.

### Evaluation Board Information

The following evaluation boards are available to aid in the testing and layout of this device:

Eval Board	Description	Products
KEB002	Single Channel, Dual Supply 5 & 6 lead SOT23	KM4112IT5

Evaluation board schematics and layouts are shown in Figure 5 and Figure 6.

The KEB002 evaluation board is built for dual supply operation. Follow these steps to use the board in a single supply application:

1. Short  $-V_s$  to ground
2. Use C3 and C4, if the  $-V_s$  pin of the KM4112 is not directly connected to the ground plane.

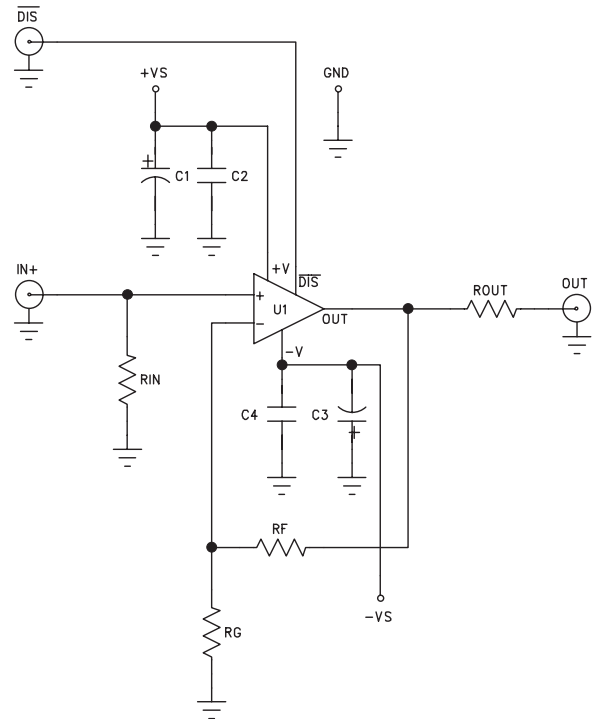

Figure 5: Evaluation Board Schematic

# KM4112 Evaluation Board Layout

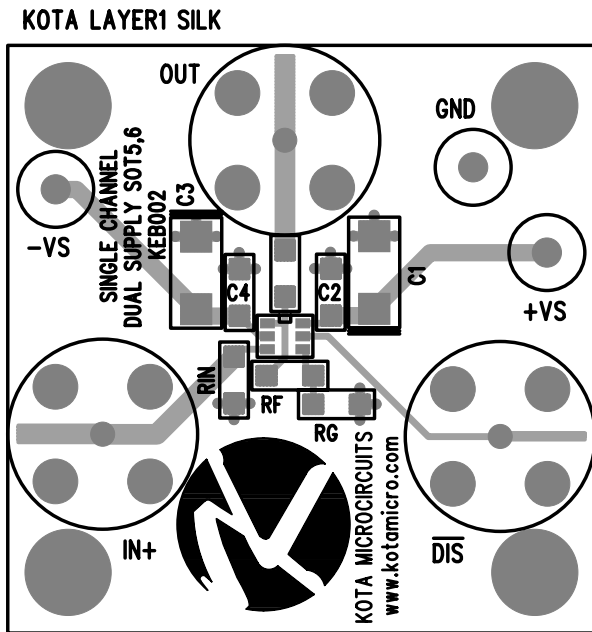

Figure 6a: KEB002 (top side)

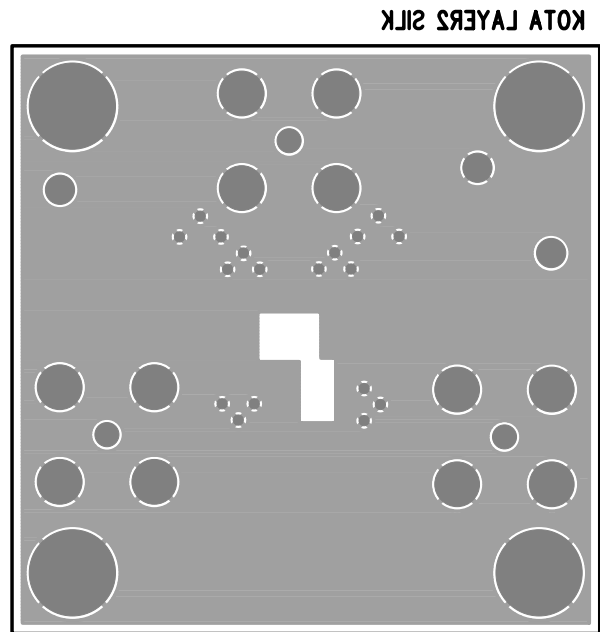
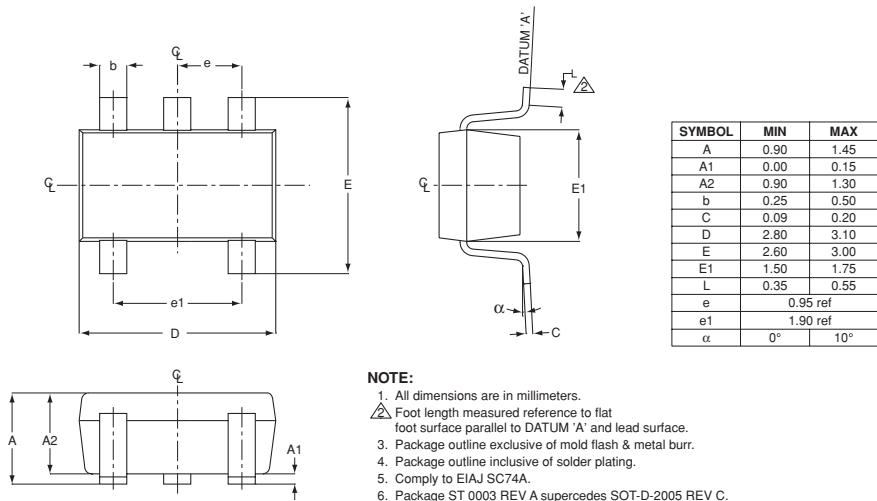

Figure 6b: KEB002 (bottom side)

## KM4112 Package Dimensions

SOT23-5





## Ordering Information

Model	Part Number	Package	Container	Pack Qty
KM4112	KM4112IT5	SOT23-5	Partial Reel	<3000
KM4112	KM4112IT5TR3	SOT23-5	Reel	3000

Temperature range for all parts: -40°C to +85°C

### DISCLAIMER

FAIRCHILD SEMICONDUCTOR RESERVES THE RIGHT TO MAKE CHANGES WITHOUT FURTHER NOTICES TO ANY PRODUCTS HEREIN TO IMPROVE RELIABILITY, FUNCTION OR DESIGN. FAIRCHILD DOES NOT ASSUME ANY LIABILITY ARISING OUT OF THE APPLICATION OR USE OF ANY PRODUCT OR CIRCUIT DESCRIBED HEREIN; NEITHER DOES IT CONVEY ANY LICENSE UNDER ITS PATENT RIGHTS, NOR THE RIGHTS OF OTHERS.

### LIFE SUPPORT POLICY

FAIRCHILD'S PRODUCTS ARE NOT AUTHORIZED FOR USE AS CRITICAL COMPONENTS IN LIFE SUPPORT DEVICES OR SYSTEMS WITHOUT THE EXPRESS WRITTEN APPROVAL OF THE PRESIDENT OF FAIRCHILD SEMICONDUCTOR CORPORATION. As used herein:

1. Life support devices or systems are devices or systems which, (a) are intended for surgical implant into the body, or (b) support or sustain life, and (c) whose failure to perform when properly used in accordance with instructions for use provided in the labeling, can be reasonably expected to result in a significant injury of the user.
2. A critical component in any component of a life support device or system whose failure to perform can be reasonably expected to cause the failure of the life support device or system, or to affect its safety or effectiveness.