

KSH31/31C

General Purpose Amplifier Low Speed Switching Applications

- Load Formed for Surface Mount Application (No Suffix)
- Straight Lead (I-PAK, "- I" Suffix)
- Electrically Similar to Popular TIP31 and TIP31C

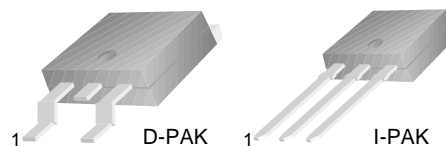

1.Base 2.Collector 3.Emitter

NPN Epitaxial Silicon Transistor

Absolute Maximum Ratings $T_C=25^\circ\text{C}$ unless otherwise noted

Symbol	Parameter	Value	Units
V_{CBO}	Collector-Base Voltage		
	: KSH31	40	V
	: KSH31C	100	V
V_{CEO}	Collector-Emitter Voltage		
	: KSH31	40	V
	: KSH31C	100	V
V_{EBO}	Emitter-Base Voltage	5	V
I_C	Collector Current (DC)	3	A
I_{CP}	Collector Current (Pulse)	1	A
I_B	Base Current	1	A
P_C	Collector Dissipation ($T_C=25^\circ\text{C}$)	15	W
	Collector Dissipation ($T_a=25^\circ\text{C}$)	1.56	W
T_J	Junction Temperature	150	$^\circ\text{C}$
T_{STG}	Storage Temperature	- 65 ~ 150	$^\circ\text{C}$

Electrical Characteristics $T_C=25^\circ\text{C}$ unless otherwise noted

Symbol	Parameter	Test Condition	Min.	Max.	Units
$V_{CEO(sus)}$	* Collector-Emitter Sustaining Voltage				
	: KSH31	$I_C = 30\text{mA}, I_B = 0$	40		V
	: KSH31C		100		V
I_{CEO}	Collector Cut-off Current				
	: KSH31	$V_{CE} = 40\text{V}, I_B = 0$		50	μA
	: KSH31C	$V_{CE} = 60\text{V}, I_B = 0$		50	μA
I_{CES}	Collector Cut-off Current				
	: KSH31	$V_{CE} = 40\text{V}, V_{BE} = 0$		20	μA
	: KSH31C	$V_{CE} = 100\text{V}, V_{BE} = 0$		20	μA
I_{EBO}	Emitter Cut-off Current	$V_{BE} = 5\text{V}, I_C = 0$		1	mA
h_{FE}	* DC Current Gain	$V_{CE} = 4\text{V}, I_C = 1\text{A}$	25		
		$V_{CE} = 4\text{V}, I_C = 3\text{A}$	10	50	
$V_{CE(sat)}$	* Collector-Emitter Saturation Voltage	$I_C = 3\text{A}, I_B = 375\text{mA}$		1.2	V
$V_{BE(on)}$	* Base-Emitter ON Voltage	$V_{CE} = 4\text{A}, I_C = 3\text{A}$		1.8	V
f_T	Current Gain Bandwidth Product	$V_{CE} = 10\text{V}, I_C = 500\text{mA}$	3		MHz

* Pulse Test: $PW \leq 300\mu\text{s}$, Duty Cycles $\leq 2\%$

Typical Characteristics

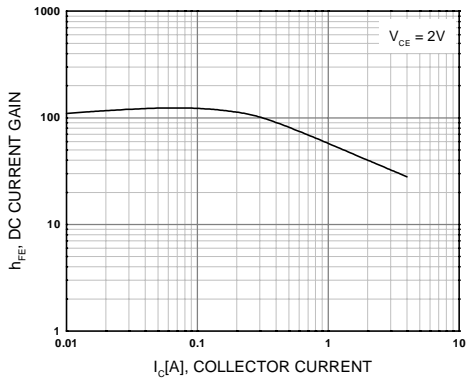

Figure 1. DC current Gain

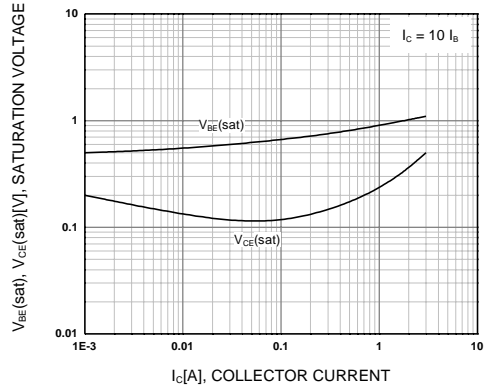

Figure 2. Base-Emitter Saturation Voltage
Collector-Emitter Saturation Voltage

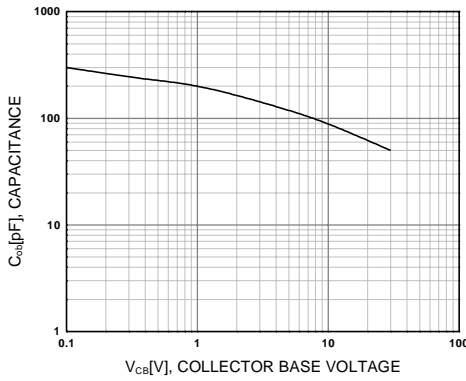

Figure 3. Collector Capacitance

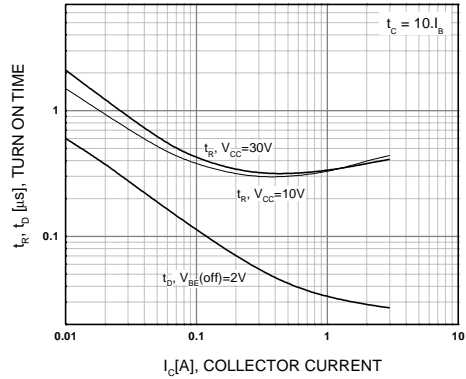

Figure 4. Turn On Time

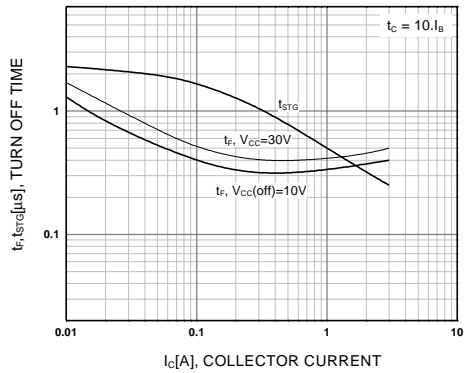

Figure 5. Turn Off Time

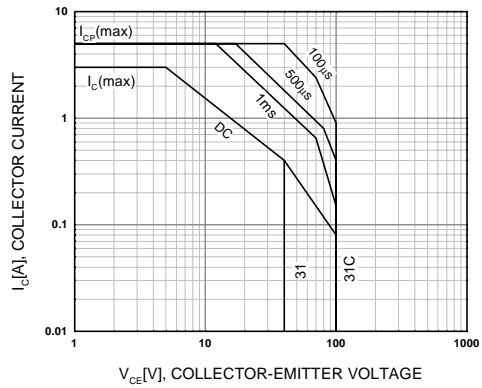

Figure 6. Safe Operating

Typical Characteristics (Continued)

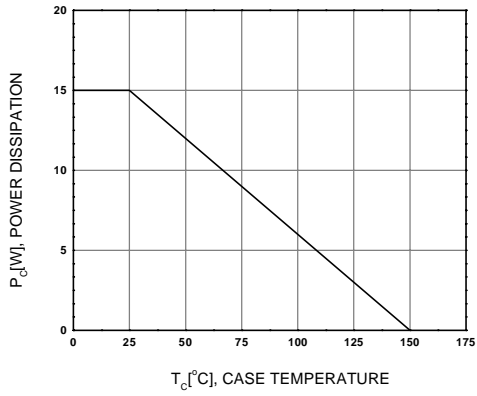
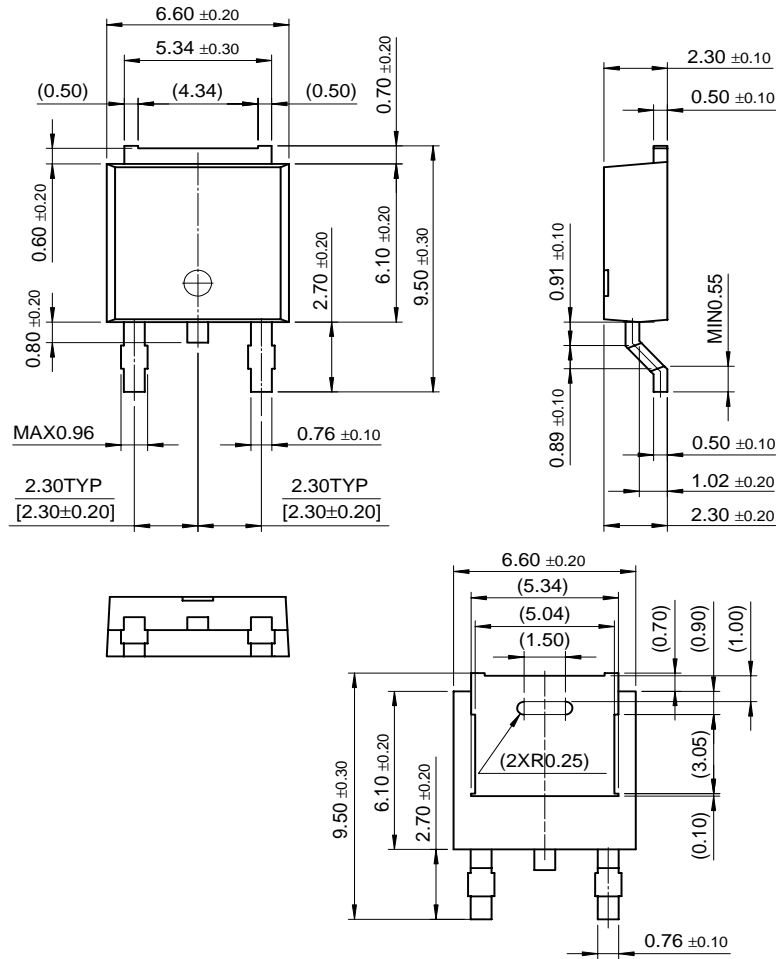

Figure 7. Power Derating

Package Dimensions

KSH31/31C

D-PAK



Dimensions in Millimeters

TRADEMARKS

The following are registered and unregistered trademarks Fairchild Semiconductor owns or is authorized to use and is not intended to be an exhaustive list of all such trademarks.

ACEx™	FAST®	OPTOPLANAR™	STAR*POWER™
Bottomless™	FASTr™	PACMAN™	Stealth™
CoolFET™	FRFET™	POP™	SuperSOT™-3
CROSSVOLT™	GlobalOptoisolator™	Power247™	SuperSOT™-6
DenseTrench™	GTO™	PowerTrench®	SuperSOT™-8
DOMET™	HiSeC™	QFET™	SyncFET™
EcoSPARK™	ISOPLANAR™	QS™	TruTranslation™
E ² CMOS™	LittleFET™	QT Optoelectronics™	TinyLogic™
EnSigna™	MicroFET™	Quiet Series™	UHC™
FACT™	MICROWIRE™	SLIENT SWITCHER®	UltraFET®
FACT Quiet Series™	OPTOLOGIC™	SMART START™	VCX™

STAR*POWER is used under license

DISCLAIMER

FAIRCHILD SEMICONDUCTOR RESERVES THE RIGHT TO MAKE CHANGES WITHOUT FURTHER NOTICE TO ANY PRODUCTS HEREIN TO IMPROVE RELIABILITY, FUNCTION OR DESIGN. FAIRCHILD DOES NOT ASSUME ANY LIABILITY ARISING OUT OF THE APPLICATION OR USE OF ANY PRODUCT OR CIRCUIT DESCRIBED HEREIN; NEITHER DOES IT CONVEY ANY LICENSE UNDER ITS PATENT RIGHTS, NOR THE RIGHTS OF OTHERS.

LIFE SUPPORT POLICY

FAIRCHILD'S PRODUCTS ARE NOT AUTHORIZED FOR USE AS CRITICAL COMPONENTS IN LIFE SUPPORT DEVICES OR SYSTEMS WITHOUT THE EXPRESS WRITTEN APPROVAL OF FAIRCHILD SEMICONDUCTOR CORPORATION.

As used herein:

1. Life support devices or systems are devices or systems which, (a) are intended for surgical implant into the body, or (b) support or sustain life, or (c) whose failure to perform when properly used in accordance with instructions for use provided in the labeling, can be reasonably expected to result in significant injury to the user.
2. A critical component is any component of a life support device or system whose failure to perform can be reasonably expected to cause the failure of the life support device or system, or to affect its safety or effectiveness.

PRODUCT STATUS DEFINITIONS

Definition of Terms

Datasheet Identification	Product Status	Definition
Advance Information	Formative or In Design	This datasheet contains the design specifications for product development. Specifications may change in any manner without notice.
Preliminary	First Production	This datasheet contains preliminary data, and supplementary data will be published at a later date. Fairchild Semiconductor reserves the right to make changes at any time without notice in order to improve design.
No Identification Needed	Full Production	This datasheet contains final specifications. Fairchild Semiconductor reserves the right to make changes at any time without notice in order to improve design.
Obsolete	Not In Production	This datasheet contains specifications on a product that has been discontinued by Fairchild semiconductor. The datasheet is printed for reference information only.