

# LM2902, LM324/LM324A, LM224/ LM224A

## Quad Operational Amplifier

### Features

- Internally Frequency Compensated for Unity Gain
- Large DC Voltage Gain: 100dB
- Wide Power Supply Range:  
LM224/LM224A, LM324/LM324A : 3V~32V (or  $\pm 1.5 \sim 16V$ )  
LM2902: 3V~26V (or  $\pm 1.5V \sim 13V$ )
- Input Common Mode Voltage Range Includes Ground
- Large Output Voltage Swing: 0V to  $V_{CC} - 1.5V$
- Power Drain Suitable for Battery Operation

### Description

The LM324/LM324A, LM2902, LM224/LM224A consist of four independent, high gain, internally frequency compensated operational amplifiers which were designed specifically to operate from a single power supply over a wide voltage range. operation from split power supplies is also possible so long as the difference between the two supplies is 3 volts to 32 volts. Application areas include transducer amplifier, DC gain blocks and all the conventional OP Amp circuits which now can be easily implemented in single power supply systems.



### Internal Block Diagram

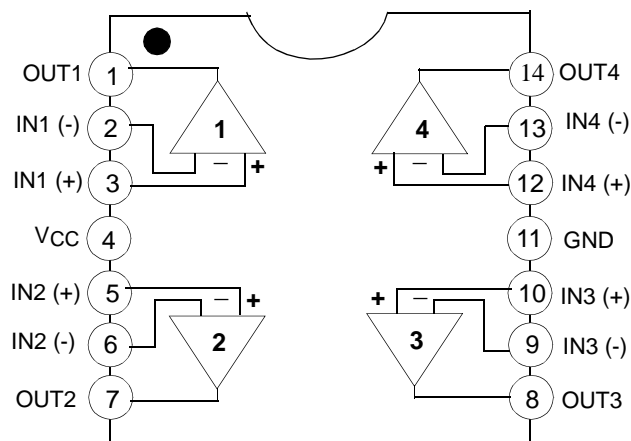

## Schematic Diagram

(One Section Only)

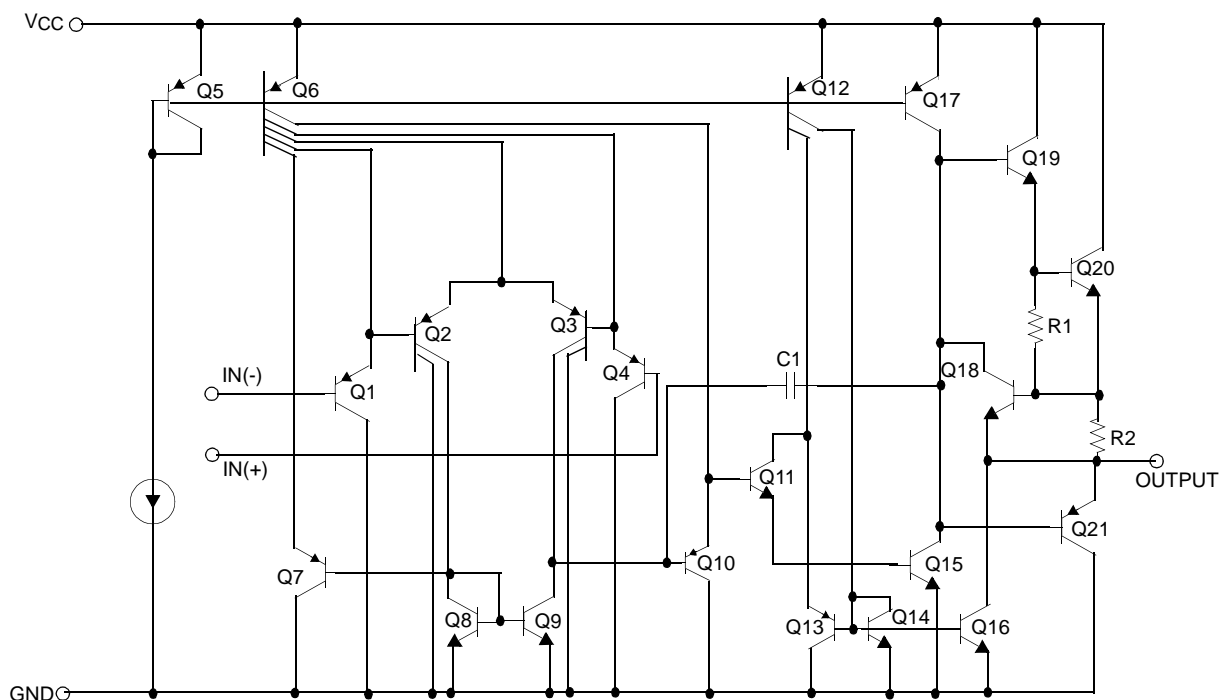

## Absolute Maximum Ratings

Parameter	Symbol	LM224/LM224A	LM324/LM324A	LM2902	Unit
Power Supply Voltage	VCC	±16 or 32	±16 or 32	±13 or 26	V
Differential Input Voltage	VI(DIFF)	32	32	26	V
Input Voltage	VI	-0.3 to +32	-0.3 to +32	-0.3 to +26	V
Output Short Circuit to GND Vcc≤15V, TA=25°C(one Amp)	-	Continuous	Continuous	Continuous	-
Power Dissipation, TA=25°C 14-DIP 14-SOP	PD	1310 640	1310 640	1310 640	mW
Operating Temperature Range	TOPR	-25 ~ +85	0 ~ +70	-40 ~ +85	°C
Storage Temperature Range	TSTG	-65 ~ +150	-65 ~ +150	-65 ~ +150	°C

## Thermal Data

Parameter	Symbol	Value	Unit
Thermal Resistance Junction-Ambient Max. 14-DIP 14-SOP	Rθja	95 195	°C/W

## Electrical Characteristics

( $V_{CC} = 5.0V$ ,  $V_{EE} = GND$ ,  $T_A = 25^\circ C$ , unless otherwise specified)

Parameter	Symbol	Conditions	LM224			LM324			LM2902			Unit	
			Min.	Typ.	Max.	Min.	Typ.	Max.	Min.	Typ.	Max.		
Input Offset Voltage	$V_{IO}$	$V_{CM} = 0V$ to $V_{CC} - 1.5V$ $V_{O(P)} = 1.4V$ , $R_S = 0\Omega$ (Note1)	-	1.5	5.0	-	1.5	7.0	-	1.5	7.0	mV	
Input Offset Current	$I_{IO}$	$V_{CM} = 0V$	-	2.0	30	-	3.0	50	-	3.0	50	nA	
Input Bias Current	$I_{BIAS}$	$V_{CM} = 0V$	-	40	150	-	40	250	-	40	250	nA	
Input Common-Mode Voltage Range	$V_{I(R)}$	Note1	0	-	$V_{CC} - 1.5$	0	$V_{CC} - 1.5$	-	0	-	$V_{CC} - 1.5$	V	
Supply Current	$I_{CC}$	$R_L = \infty$ , $V_{CC} = 30V$ (LM2902, $V_{CC} = 26V$ )	-	1.0	3	-	1.0	3	-	1.0	3	mA	
		$R_L = \infty$ , $V_{CC} = 5V$	-	0.7	1.2	-	0.7	1.2	-	0.7	1.2	mA	
Large Signal Voltage Gain	$G_V$	$V_{CC} = 15V$ , $R_L = 2k\Omega$ $V_{O(P)} = 1V$ to $11V$	50	100	-	25	100	-	25	100	-	V/ mV	
Output Voltage Swing	$V_{O(H)}$	Note1	$R_L = 2k\Omega$	26	-	-	26	-	-	22	-	-	V
			$R_L = 10k\Omega$	27	28	-	27	28	-	23	24	-	V
	$V_{O(L)}$	$V_{CC} = 5V$ , $R_L = 10k\Omega$	-	5	20	-	5	20	-	5	100	mV	
Common-Mode Rejection Ratio	CMRR	-	70	85	-	65	75	-	50	75	-	dB	
Power Supply Rejection Ratio	PSRR	-	65	100	-	65	100	-	50	100	-	dB	
Channel Separation	CS	$f = 1kHz$ to $20kHz$ (Note2)	-	120	-	-	120	-	-	120	-	dB	
Short Circuit to GND	$I_{SC}$	$V_{CC} = 15V$	-	40	60	-	40	60	-	40	60	mA	
Output Current	$I_{SOURCE}$	$V_{I(+)} = 1V$ , $V_{I(-)} = 0V$ $V_{CC} = 15V$ $V_{O(P)} = 2V$	20	40	-	20	40	-	20	40	-	mA	
	$I_{SINK}$	$V_{I(+)} = 0V$ , $V_{I(-)} = 1V$ $V_{CC} = 15V$ $V_{O(P)} = 2V$	10	13	-	10	13	-	10	13	-	mA	
		$V_{I(+)} = 0V$ , $V_{I(-)} = 1V$ $V_{CC} = 5V$ , $V_{O(R)} = 200mV$	12	45	-	12	45	-	-	-	-	$\mu A$	
Differential Input Voltage	$V_{I(DIFF)}$	-	-	-	$V_{CC}$	-	-	$V_{CC}$	-	-	$V_{CC}$	V	

### Note :

1.  $V_{CC} = 30V$  for LM224 and LM324,  $V_{CC} = 26V$  for LM2902
2. This parameter, although guaranteed, is not 100% tested in production.

**Electrical Characteristics** (Continued)

(VCC = 5.0V, VEE = GND, unless otherwise specified)

The following specifications apply over the range of  $-25^{\circ}\text{C} \leq T_A \leq +85^{\circ}\text{C}$  for the LM224; and the  $0^{\circ}\text{C} \leq T_A \leq +70^{\circ}\text{C}$  for the LM324; and the  $-40^{\circ}\text{C} \leq T_A \leq +85^{\circ}\text{C}$  for the LM2902

Parameter	Symbol	Conditions	LM224			LM324			LM2902			Unit	
			Min.	Typ.	Max.	Min.	Typ.	Max.	Min.	Typ.	Max.		
Input Offset Voltage	V <sub>IO</sub>	V <sub>ICM</sub> = 0V to V <sub>CC</sub> -1.5V V <sub>O(P)</sub> = 1.4V, R <sub>S</sub> = 0Ω (Note1)	-	-	7.0	-	-	9.0	-	-	10.0	mV	
Input Offset Voltage Drift	ΔV <sub>IO</sub> /ΔT	R <sub>S</sub> = 0Ω (Note2)	-	7.0	-	-	7.0	-	-	7.0	-	μV/°C	
Input Offset Current	I <sub>IO</sub>	V <sub>CM</sub> = 0V	-	-	100	-	-	150	-	-	200	nA	
Input Offset Current Drift	ΔI <sub>IO</sub> /ΔT	R <sub>S</sub> = 0Ω (Note2)	-	10	-	-	10	-	-	10	-	pA/°C	
Input Bias Current	I <sub>BIAS</sub>	V <sub>CM</sub> = 0V	-	-	300	-	-	500	-	-	500	nA	
Input Common-Mode Voltage Range	V <sub>I(R)</sub>	Note1	0	-	V <sub>CC</sub> -2.0	0	-	V <sub>CC</sub> -2.0	0	-	V <sub>CC</sub> -2.0	V	
Large Signal Voltage Gain	G <sub>V</sub>	V <sub>CC</sub> = 15V, R <sub>L</sub> = 2.0kΩ V <sub>O(P)</sub> = 1V to 11V	25	-	-	15	-	-	15	-	-	V/mV	
Output Voltage Swing	V <sub>O(H)</sub>	Note1	R <sub>L</sub> =2kΩ	26	-	-	26	-	-	22	-	-	V
			R <sub>L</sub> =10kΩ	27	28	-	27	28	-	23	24	-	V
	V <sub>O(L)</sub>	V <sub>CC</sub> = 5V, R <sub>L</sub> =10kΩ	-	5	20	-	5	20	-	5	100	mV	
Output Current	I <sub>SOURCE</sub>	V <sub>I(+)</sub> = 1V, V <sub>I(-)</sub> = 0V V <sub>CC</sub> = 15V, V <sub>O(P)</sub> = 2V	10	20	-	10	20	-	10	20	-	mA	
	I <sub>SINK</sub>	V <sub>I(+)</sub> = 0V, V <sub>I(-)</sub> = 1V V <sub>CC</sub> = 15V, V <sub>O(P)</sub> = 2V	10	13	-	5	8	-	5	8	-	mA	
Differential Input Voltage	V <sub>I(DIFF)</sub>	-	-	-	V <sub>CC</sub>	-	-	V <sub>CC</sub>	-	-	V <sub>CC</sub>	V	

**Note:**

- V<sub>CC</sub>=30V for LM224 and LM324, V<sub>CC</sub> = 26V for LM2902
- These parameters, although guaranteed, are not 100% tested in production.

**Electrical Characteristics** (Continued)(V<sub>CC</sub> = 5.0V, V<sub>EE</sub> = GND, T<sub>A</sub> = 25°C, unless otherwise specified)

Parameter	Symbol	Conditions	LM224A			LM324A			Unit	
			Min.	Typ.	Max.	Min.	Typ.	Max.		
Input Offset Voltage	V <sub>IO</sub>	V <sub>CM</sub> = 0V to V <sub>CC</sub> -1.5V V <sub>O(P)</sub> = 1.4V, R <sub>S</sub> = 0Ω (Note1)	-	1.0	3.0	-	1.5	3.0	mV	
Input Offset Current	I <sub>IO</sub>	V <sub>CM</sub> = 0V	-	2	15	-	3.0	30	nA	
Input Bias Current	I <sub>BIAS</sub>	V <sub>CM</sub> = 0V	-	40	80	-	40	100	nA	
Input Common-Mode Voltage Range	V <sub>I(R)</sub>	V <sub>CC</sub> = 30V	0	-	V <sub>CC</sub> -1.5	0	-	V <sub>CC</sub> -1.5	V	
Supply Current	I <sub>CC</sub>	V <sub>CC</sub> = 30V, R <sub>L</sub> = ∞	-	1.5	3	-	1.5	3	mA	
		V <sub>CC</sub> = 5V, R <sub>L</sub> = ∞	-	0.7	1.2	-	0.7	1.2	mA	
Large Signal Voltage Gain	G <sub>V</sub>	V <sub>CC</sub> = 15V, R <sub>L</sub> = 2kΩ V <sub>O(P)</sub> = 1V to 11V	50	100	-	25	100	-	V/mV	
Output Voltage Swing	V <sub>O(H)</sub>	Note1	R <sub>L</sub> = 2kΩ	26	-	-	26	-	-	V
			R <sub>L</sub> = 10kΩ	27	28	-	27	28	-	V
	V <sub>O(L)</sub>	V <sub>CC</sub> = 5V, R <sub>L</sub> = 10kΩ	-	5	20	-	5	20	mV	
Common-Mode Rejection Ratio	CMRR	-	70	85	-	65	85	-	dB	
Power Supply Rejection Ratio	PSRR	-	65	100	-	65	100	-	dB	
Channel Separation	CS	f = 1kHz to 20kHz (Note2)	-	120	-	-	120	-	dB	
Short Circuit to GND	I <sub>SC</sub>	V <sub>CC</sub> = 15V	-	40	60	-	40	60	mA	
Output Current	I <sub>SOURCE</sub>	V <sub>I(+)</sub> = 1V, V <sub>I(-)</sub> = 0V V <sub>CC</sub> = 15V, V <sub>O(P)</sub> = 2V	20	40	-	20	40	-	mA	
		V <sub>I(+)</sub> = 0V, V <sub>I(-)</sub> = 1V V <sub>CC</sub> = 15V, V <sub>O(P)</sub> = 2V	10	20	-	10	20	-	mA	
	I <sub>SINK</sub>	V <sub>I(+)</sub> = 0V, V <sub>I(-)</sub> = 1V V <sub>CC</sub> = 5V V <sub>O(P)</sub> = 200mV	12	50	-	12	50	-	μA	
Differential Input Voltage	V <sub>I(DIFF)</sub>	-	-	-	V <sub>CC</sub>	-	-	V <sub>CC</sub>	V	

**Note:**

- V<sub>CC</sub> = 30V for LM224A, LM324A
- This parameter, although guaranteed, is not 100% tested in production.

**Electrical Characteristics** (Continued)

(VCC = 5.0V, VEE = GND, unless otherwise specified)

The following specification apply over the range of  $-25^{\circ}\text{C} \leq T_A \leq +85^{\circ}\text{C}$  for the LM224A; and the  $0^{\circ}\text{C} \leq T_A \leq +70^{\circ}\text{C}$  for the LM324A

Parameter	Symbol	Conditions	LM224A			LM324A			Unit	
			Min.	Typ.	Max.	Min.	Typ.	Max.		
Input Offset Voltage	V <sub>IO</sub>	V <sub>CM</sub> = 0V to V <sub>CC</sub> -1.5V V <sub>O(P)</sub> = 1.4V, R <sub>S</sub> = 0Ω (Note1)	-	-	4.0	-	-	5.0	mV	
Input Offset Voltage Drift	ΔV <sub>IO</sub> /ΔT	R <sub>S</sub> = 0Ω (Note2)	-	7.0	20	-	7.0	30	μV/°C	
Input Offset Current	I <sub>IO</sub>	V <sub>CM</sub> = 0V	-	-	30	-	-	75	nA	
Input Offset Current Drift	ΔI <sub>IO</sub> /ΔT	R <sub>S</sub> = 0Ω (Note2)	-	10	200	-	10	300	pA/°C	
Input Bias Current	I <sub>BIAS</sub>	-	-	40	100	-	40	200	nA	
Input Common-Mode Voltage Range	V <sub>I(R)</sub>	Note1	0	-	V <sub>CC</sub> -2.0	0	-	V <sub>CC</sub> -2.0	V	
Large Signal Voltage Gain	G <sub>V</sub>	V <sub>CC</sub> = 15V, R <sub>L</sub> = 2.0kΩ	25	-	-	15	-	-	V/mV	
Output Voltage Swing	V <sub>O(H)</sub>	Note1	R <sub>L</sub> = 2kΩ	26	-	-	26	-	-	V
			R <sub>L</sub> = 10kΩ	27	28	-	27	28	-	V
	V <sub>O(L)</sub>	V <sub>CC</sub> = 5V, R <sub>L</sub> = 10kΩ	-	5	20	-	5	20	mV	
Output Current	I <sub>SOURCE</sub>	V <sub>I(+)</sub> = 1V, V <sub>I(-)</sub> = 0V V <sub>CC</sub> = 15V, V <sub>O(P)</sub> = 2V	10	20	-	10	20	-	mA	
	I <sub>SINK</sub>	V <sub>I(+)</sub> = 0V, V <sub>I(-)</sub> = 1V V <sub>CC</sub> = 15V, V <sub>O(P)</sub> = 2V	5	8	-	5	8	-	mA	
Differential Input Voltage	V <sub>I(DIFF)</sub>	-	-	-	V <sub>CC</sub>	-	-	V <sub>CC</sub>	V	

**Note:**

1. V<sub>CC</sub> = 30V for LM224A and LM324A.
2. These parameters, although guaranteed, are not 100% tested in production.

# Typical Performance Characteristics

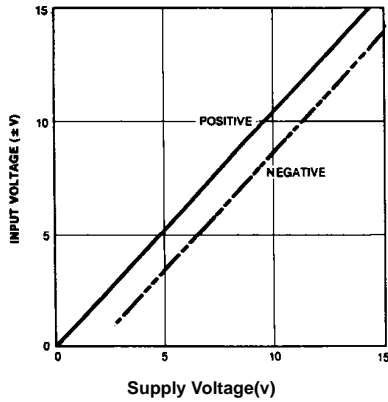

Figure 1. Input Voltage Range vs Supply Voltage

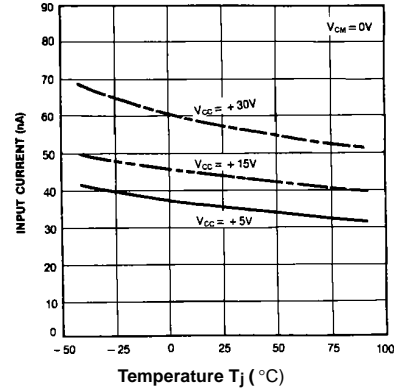

Figure 2. Input Current vs Temperature

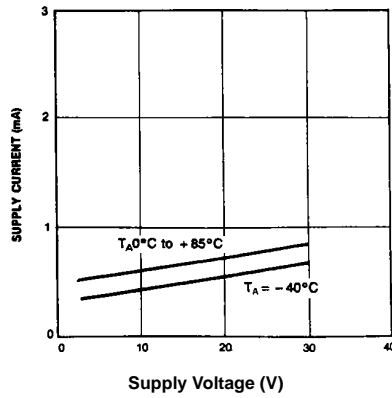

Figure 3. Supply Current vs Supply Voltage

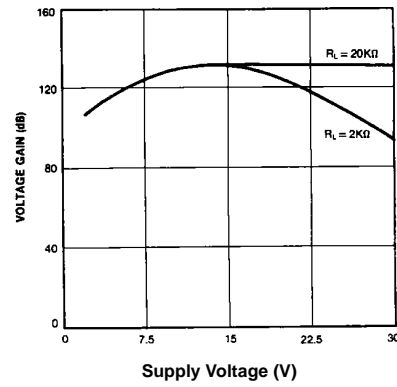

Figure 4. Voltage Gain vs Supply Voltage

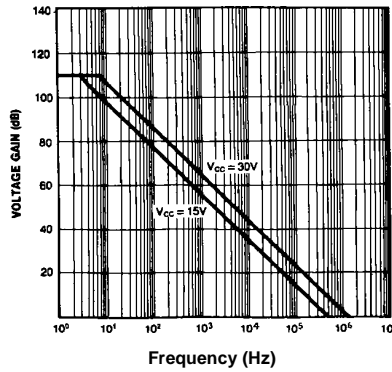

Figure 5. Open Loop Frequency Response

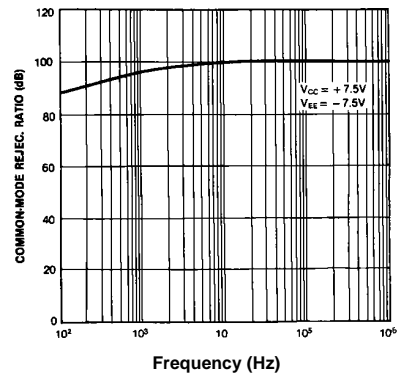

Figure 6. Common mode Rejection Ratio

## Typical Performance Characteristics (Continued)

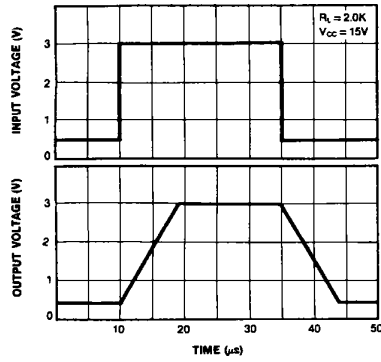

Figure 7. Voltage Follower Pulse Response

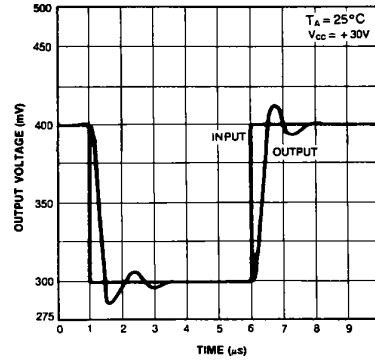

Figure 8. Voltage Follower Pulse Response (Small Signal)

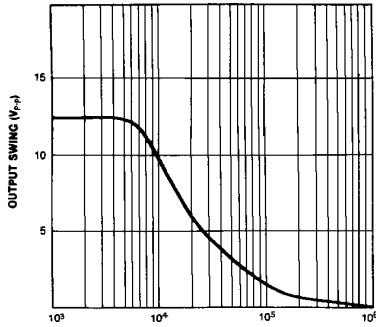

Figure 8. Large Signal Frequency Response

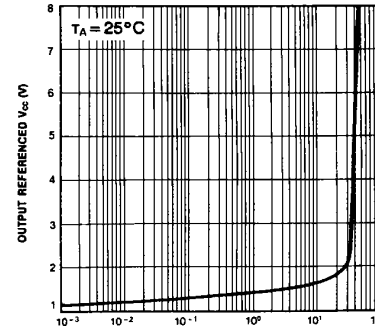

Figure 9. Output Characteristics vs Current Sourcing

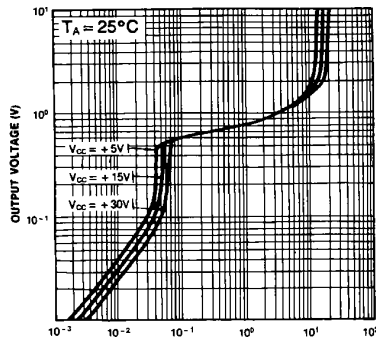

Figure 10. Output Characteristics vs Current Sinking

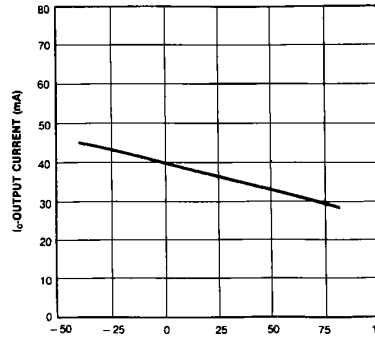

Figure 11. Current Limiting vs Temperature



# Mechanical Dimensions

## Package

Dimensions in millimeters

### 14-DIP

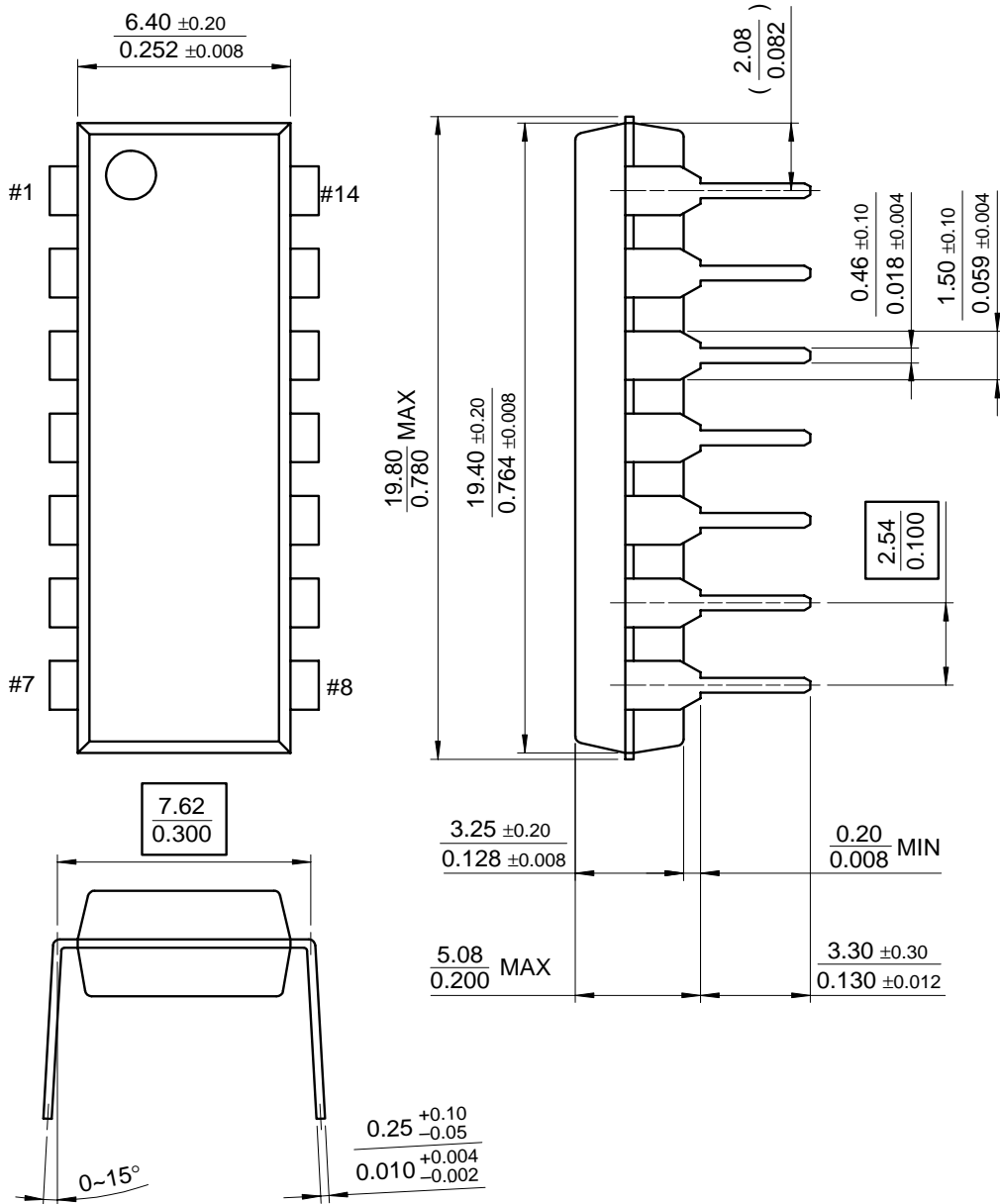

# Mechanical Dimensions (Continued)

## Package

Dimensions in millimeters

### 14-SOP

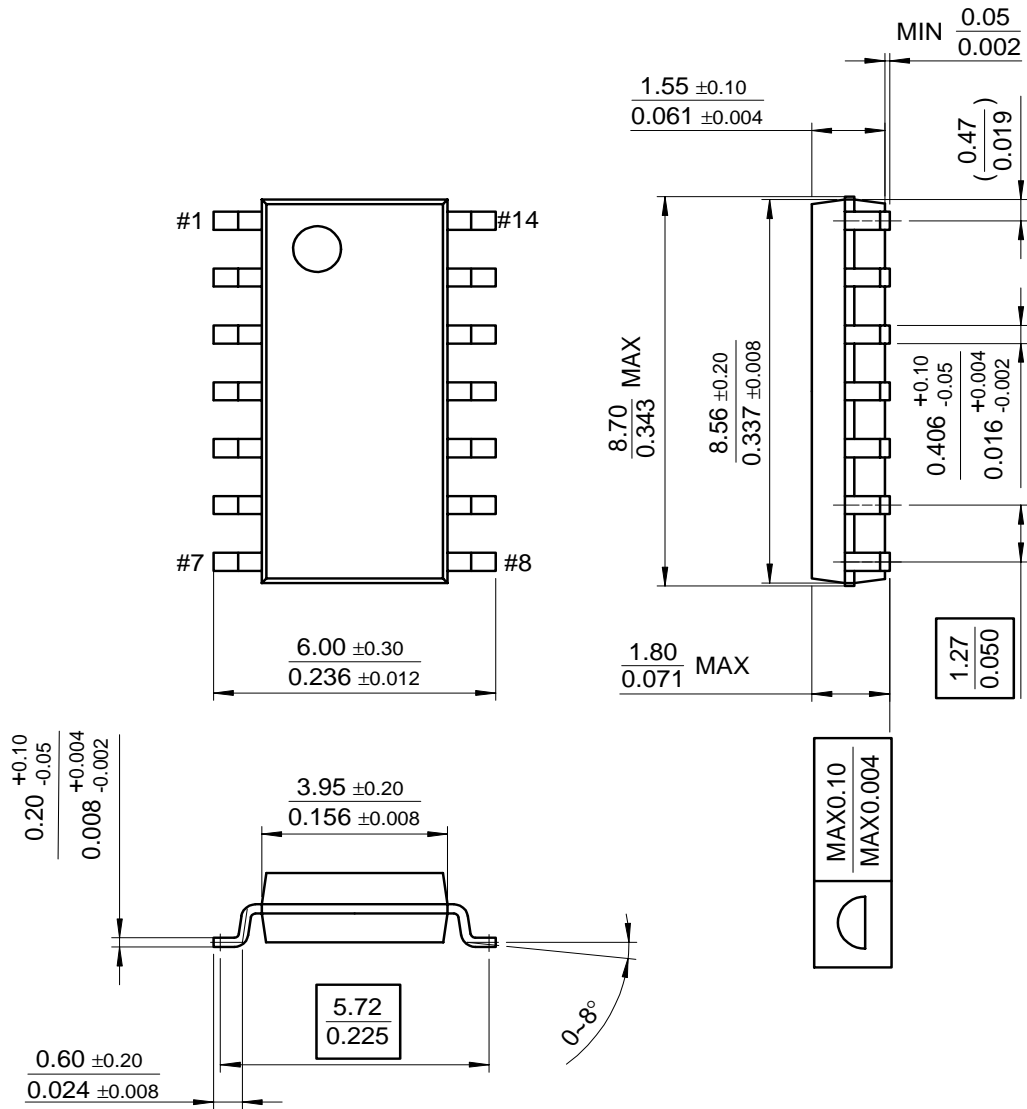

## Ordering Information

Product Number	Package	Operating Temperature
LM324N	14-DIP	0 ~ +70°C
LM324AN		
LM324M	14-SOP	
LM324AM		
LM2902N	14-DIP	-40 ~ +85°C
LM2902M	14-SOP	
LM224N	14-DIP	-25 ~ +85°C
LM224AN		
LM224M	14-SOP	
LM224AM		

#### **DISCLAIMER**

FAIRCHILD SEMICONDUCTOR RESERVES THE RIGHT TO MAKE CHANGES WITHOUT FURTHER NOTICE TO ANY PRODUCTS HEREIN TO IMPROVE RELIABILITY, FUNCTION OR DESIGN. FAIRCHILD DOES NOT ASSUME ANY LIABILITY ARISING OUT OF THE APPLICATION OR USE OF ANY PRODUCT OR CIRCUIT DESCRIBED HEREIN; NEITHER DOES IT CONVEY ANY LICENSE UNDER ITS PATENT RIGHTS, NOR THE RIGHTS OF OTHERS.

#### **LIFE SUPPORT POLICY**

FAIRCHILD'S PRODUCTS ARE NOT AUTHORIZED FOR USE AS CRITICAL COMPONENTS IN LIFE SUPPORT DEVICES OR SYSTEMS WITHOUT THE EXPRESS WRITTEN APPROVAL OF THE PRESIDENT OF FAIRCHILD SEMICONDUCTOR CORPORATION. As used herein:

1. Life support devices or systems are devices or systems which, (a) are intended for surgical implant into the body, or (b) support or sustain life, and (c) whose failure to perform when properly used in accordance with instructions for use provided in the labeling, can be reasonably expected to result in a significant injury of the user.
2. A critical component in any component of a life support device or system whose failure to perform can be reasonably expected to cause the failure of the life support device or system, or to affect its safety or effectiveness.