

# LM431A/LM431B/LM431C

## Programmable Shunt Regulator

### Features

- Programmable Output Voltage to 36 Volts
- Low Dynamic Output Impedance 0.20 Typical
- Sink Current Capability of 1.0 to 100mA
- Equivalent Full-Range Temperature Coefficient of 50ppm/°C Typical
- Temperature Compensated for Operation Over Full Rated Operating Temperature Range
- Low Output Noise Voltage
- Fast Turn-on Response

### Description

The LM431A/LM431B/LM431C are three terminal output adjustable regulators with thermal stability over operating temperature range. The output voltage can be set any value between  $V_{REF}$  (approximately 2.5 volts) and 36 volts with two external resistors. These devices have a typical dynamic output impedance of  $0.2\Omega$ . Active output circuit provides a sharp turn-on characteristic, making these devices excellent replacement for Zener Diodes in many applications.

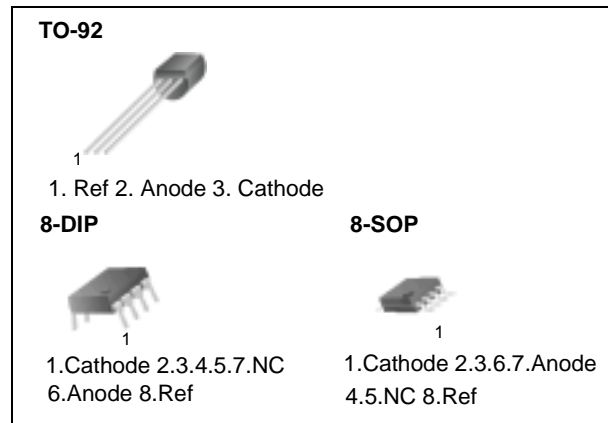

### Internal Block Diagram

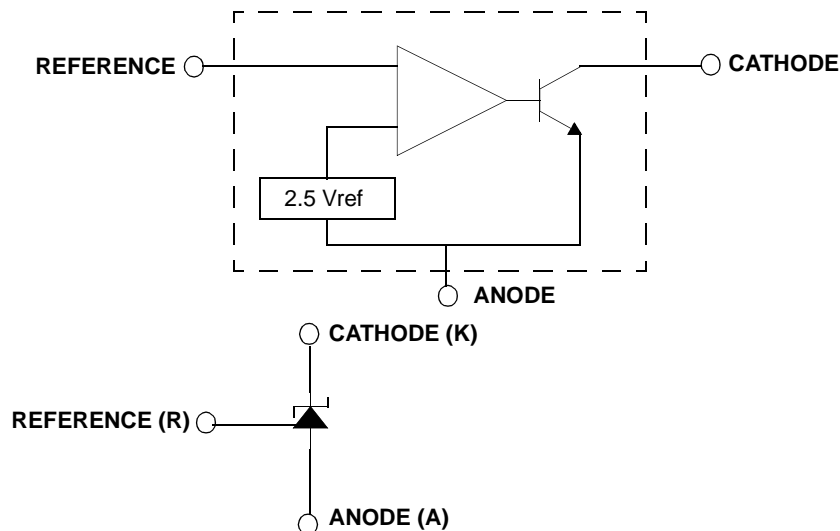

## Absolute Maximum Ratings

(Operating temperature range applies unless otherwise specified.)

Parameter	Symbol	Value	Unit
Cathode Voltage	V <sub>KA</sub>	37	V
Cathode Current Range (Continuous)	I <sub>KA</sub>	-100 ~ +150	mA
Reference Input Current Range	I <sub>REF</sub>	0.05 ~ +10	mA
Power Dissipation M, Z Suffix Package N Suffix Package	P <sub>D</sub>	770 1000	mW
<b>Operating Temperature Range</b>			
LM431xC	T <sub>OPR</sub>	-25 ~ +85	°C
LM431xI		-40 ~ +85	°C
Junction Temperature	T <sub>J</sub>	150	°C
Storage Temperature Range	T <sub>STG</sub>	-65 ~ +150	°C

## Recommended Operating Conditions

Parameter	Symbol	Min	Typ	Max	Unit
Cathode Voltage	V <sub>KA</sub>	V <sub>REF</sub>	-	36	V
Cathode Current	I <sub>KA</sub>	1.0	-	100	mA

## Electrical Characteristics

(T<sub>A</sub> = +25°C, unless otherwise specified)

Parameter	Symbol	Conditions	LM431A			LM431B			LM431C			Unit	
			Min.	Typ.	Max.	Min.	Typ.	Max.	Min.	Typ.	Max.		
Reference Input Voltage	V <sub>REF</sub>	V <sub>KA</sub> = V <sub>REF</sub> , I <sub>KA</sub> = 10mA	2.450	2.500	2.550	2.470	2.495	2.520	2.482	2.495	2.508	V	
Deviation of Reference Input Voltage Over-Temperature	$\Delta V_{REF}/\Delta T$	V <sub>KA</sub> =V <sub>REF</sub> , I <sub>KA</sub> =10mA T <sub>MIN</sub> ≤T <sub>A</sub> ≤T <sub>MAX</sub>	-	4.5	17	-	4.5	17	-	4.5	17	mV	
Ratio of Change in Reference Input Voltage to the Change in Cathode Voltage	$\Delta V_{REF}/\Delta V_{KA}$	I <sub>KA</sub> = 10mA	$\Delta V_{KA}=10V-V_{REF}$	-	-1.0	-2.7	-	-1.0	-2.7	-	-1.0	-2.7	mV/V
			$\Delta V_{KA}=36V-10V$	-	-0.5	-2.0	-	-0.5	-2.0	-	-0.5	-2.0	
Reference Input Current	I <sub>REF</sub>	I <sub>KA</sub> =10mA, R <sub>1</sub> =10kΩ,R <sub>2</sub> =∞	-	1.5	4	-	1.5	4	-	1.5	4	μA	
Deviation of Reference Input Current Over Full Temperature Range	$\Delta I_{REF}/\Delta T$	I <sub>KA</sub> =10mA, R <sub>1</sub> =10kΩ,R <sub>2</sub> =∞ T <sub>A</sub> =Full Range	-	0.4	1.2	-	0.4	1.2	-	0.4	1.2	μA	
Minimum Cathode Current for Regulation	I <sub>KA(MIN)</sub>	V <sub>KA</sub> =V <sub>REF</sub>	-	0.45	1.0	-	0.45	1.0	-	0.45	1.0	mA	
Off - Stage Cathode Current	I <sub>KA(OFF)</sub>	V <sub>KA</sub> =36V, V <sub>REF</sub> =0	-	0.05	1.0	-	0.05	1.0	-	0.05	1.0	μA	
Dynamic Impedance	Z <sub>KA</sub>	V <sub>KA</sub> =V <sub>REF</sub> , I <sub>KA</sub> =1 to 100mA f ≥1.0kHz	-	0.15	0.5	-	0.15	0.5	-	0.15	0.5	Ω	

### Note1

- LM431XC : T<sub>MIN</sub> = -25 °C, T<sub>MAX</sub> = +85 °C
- LM431XI : T<sub>MIN</sub> = -40 °C, T<sub>MAX</sub> = +85 °C

## Test Circuits

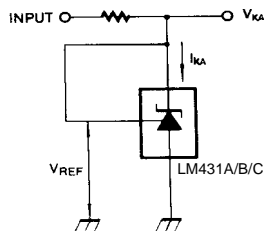

Figure 1. Test Circuit for  $V_{KA} = V_{REF}$

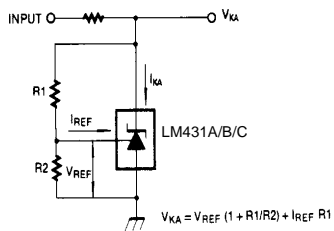

Figure 2. Test Circuit for  $V_{KA} \geq V_{REF}$

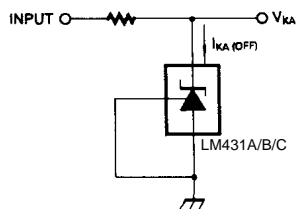

Figure 3. Test Circuit for  $I_{KA(OFF)}$

# Typical Performance Characteristics

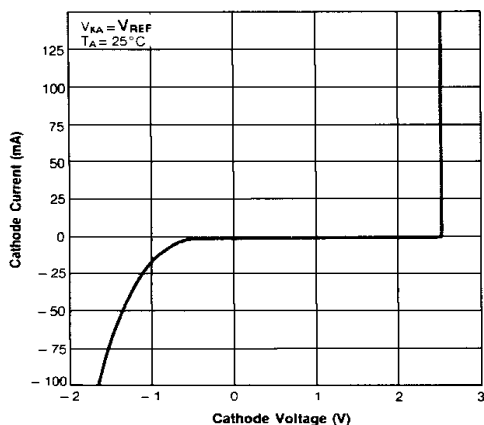

Figure 4. Cathode Current vs. Cathode Voltage

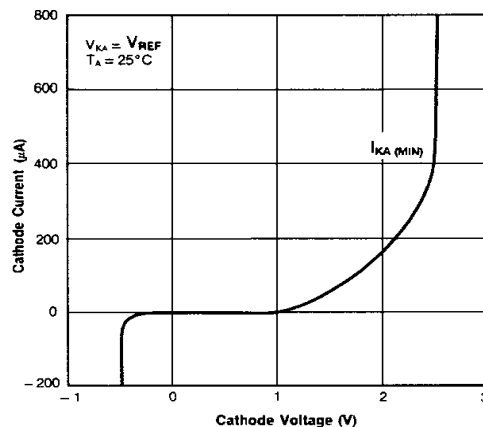

Figure 5. Cathode Current vs. Cathode Voltage

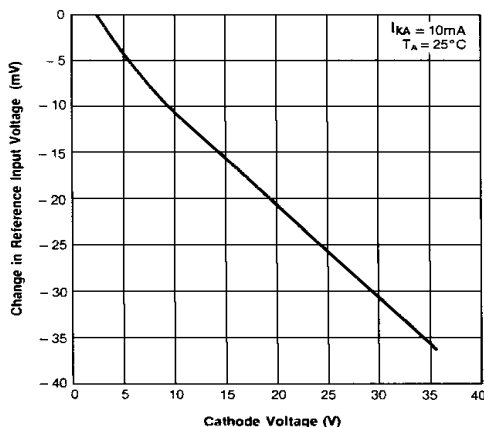

Figure 6. Change In Reference Input Voltage vs. Cathode Voltage

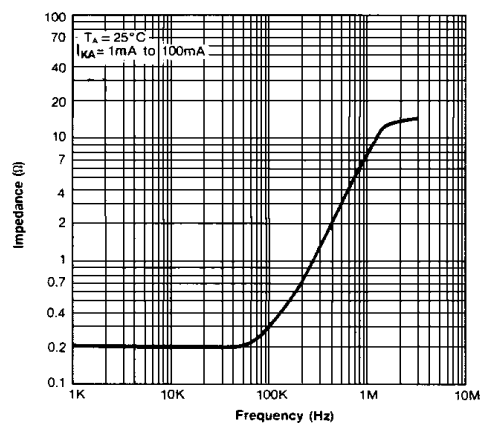

Figure 7. Dynamic Impedance Frequency

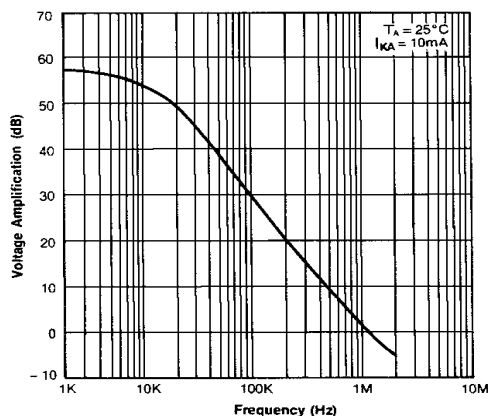

Figure 8. Small Signal Voltage Amplification vs. Frequency

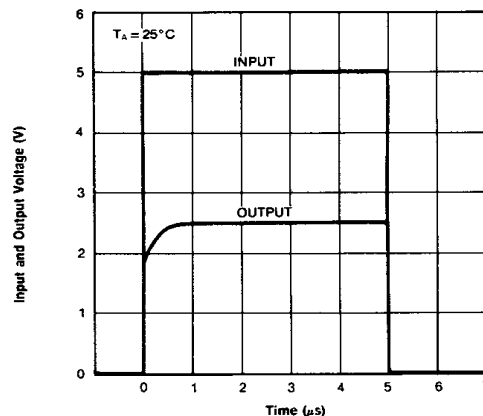

Figure 9. Pulse Response

## Typical Performance Characteristics (Continued)

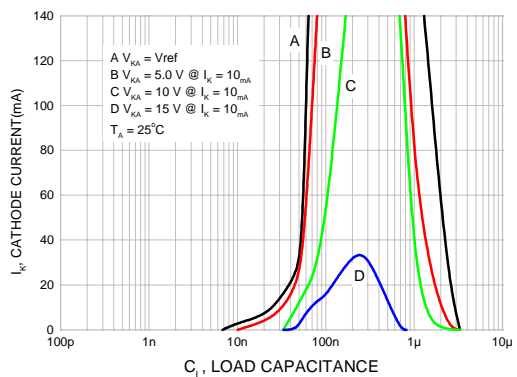

Figure 10. Stability Boundary Conditions

## Typical Application

$$V_O = \left(1 + \frac{R_1}{R_2}\right)V_{ref}$$

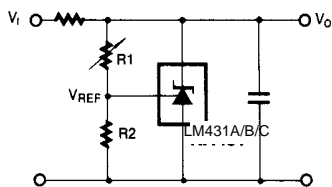

Figure 11. Shunt Regulator

$$V_O = V_{ref} \left(1 + \frac{R_1}{R_2}\right)$$

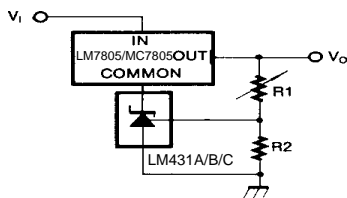

Figure 12. Output Control for Three-Terminal Fixed Regulator

$$V_O = \left(1 + \frac{R_1}{R_2}\right)V_{ref}$$

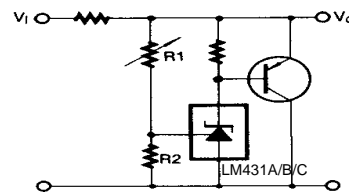

Figure 13. High Current Shunt Regulator

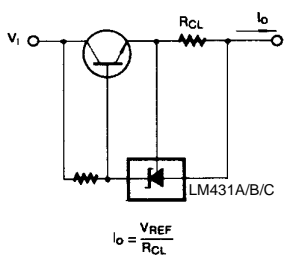

Figure 14. Current Limit or Current Source

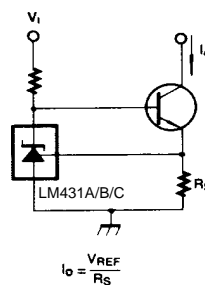

Figure 15. Constant-Current Sink

# Mechanical Dimensions

Package

Dimensions in millimeters

## TO-92

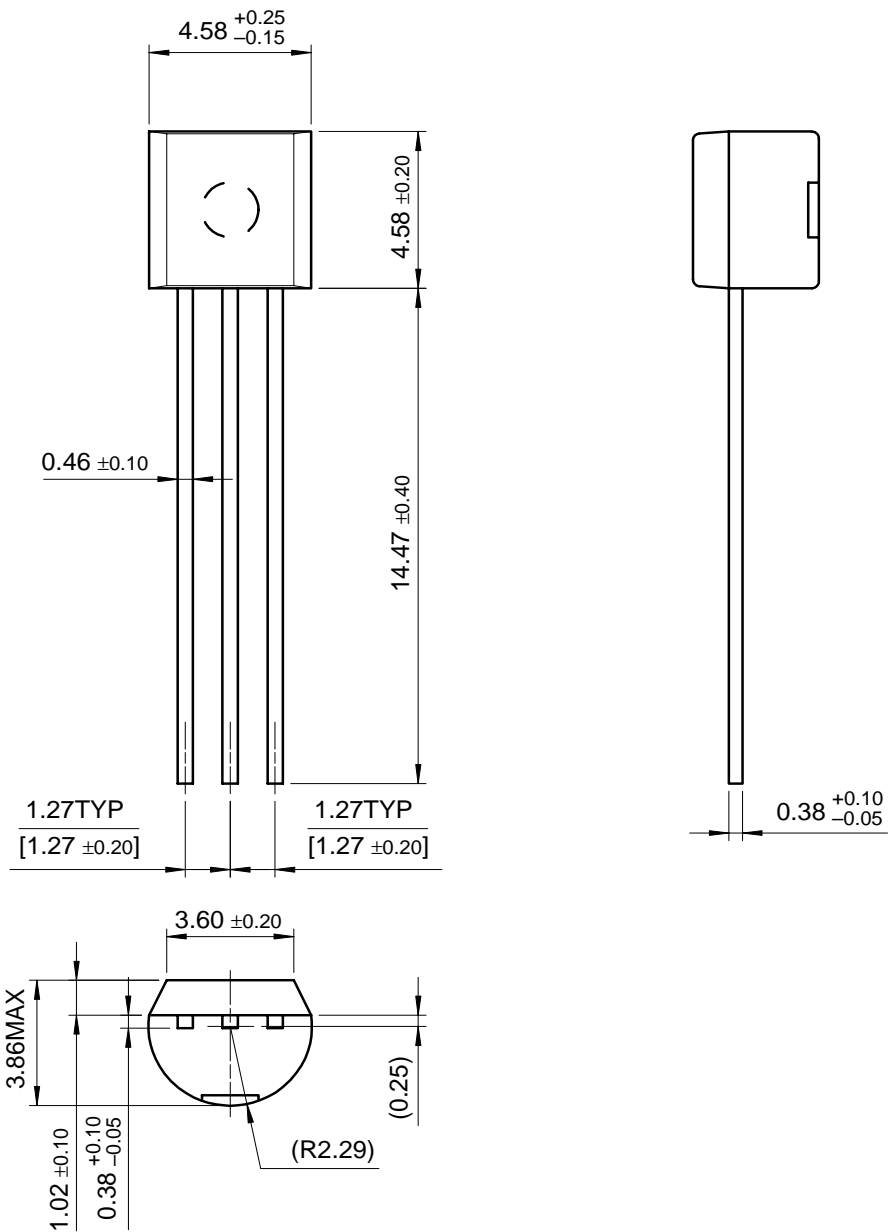



# Mechanical Dimensions (Continued)

Package

Dimensions in millimeters

## 8-SOP

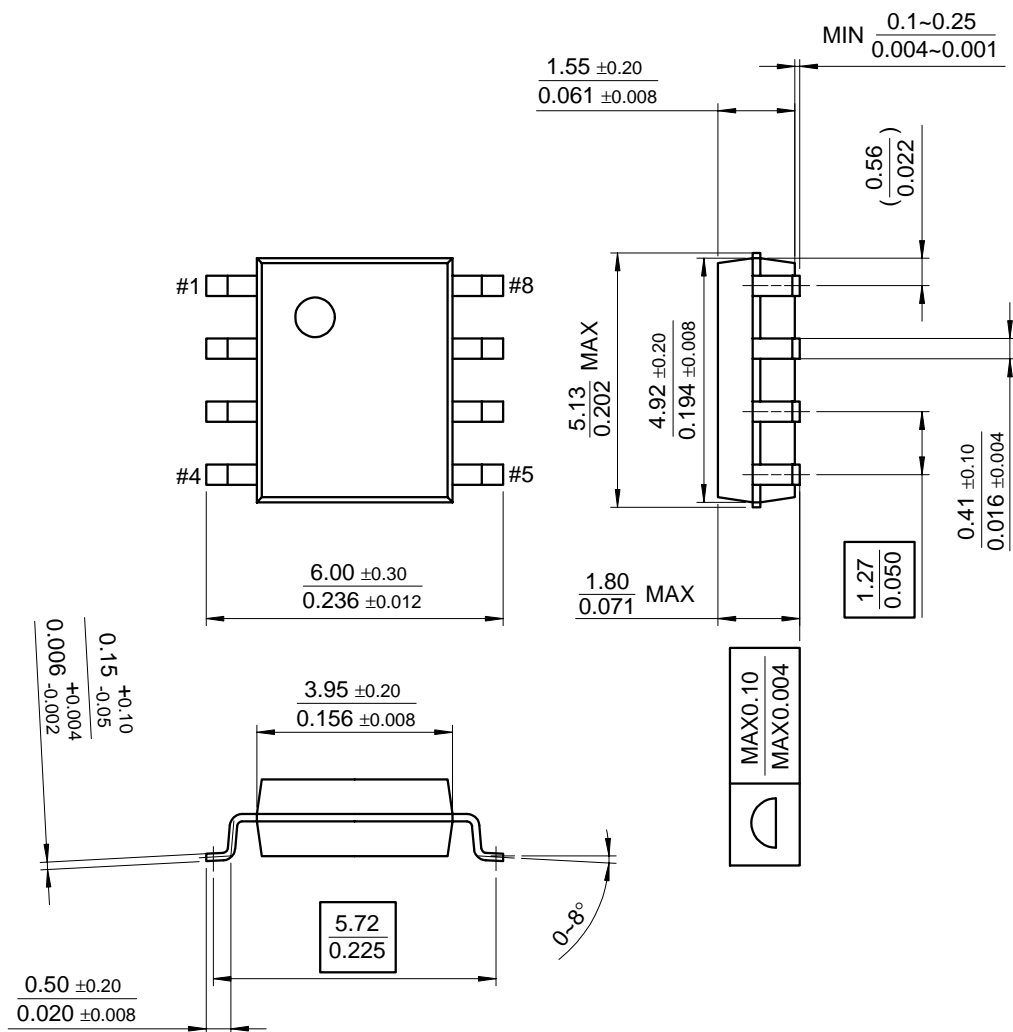

# Mechanical Dimensions (Continued)

## Package

Dimensions in millimeters

### 8-DIP

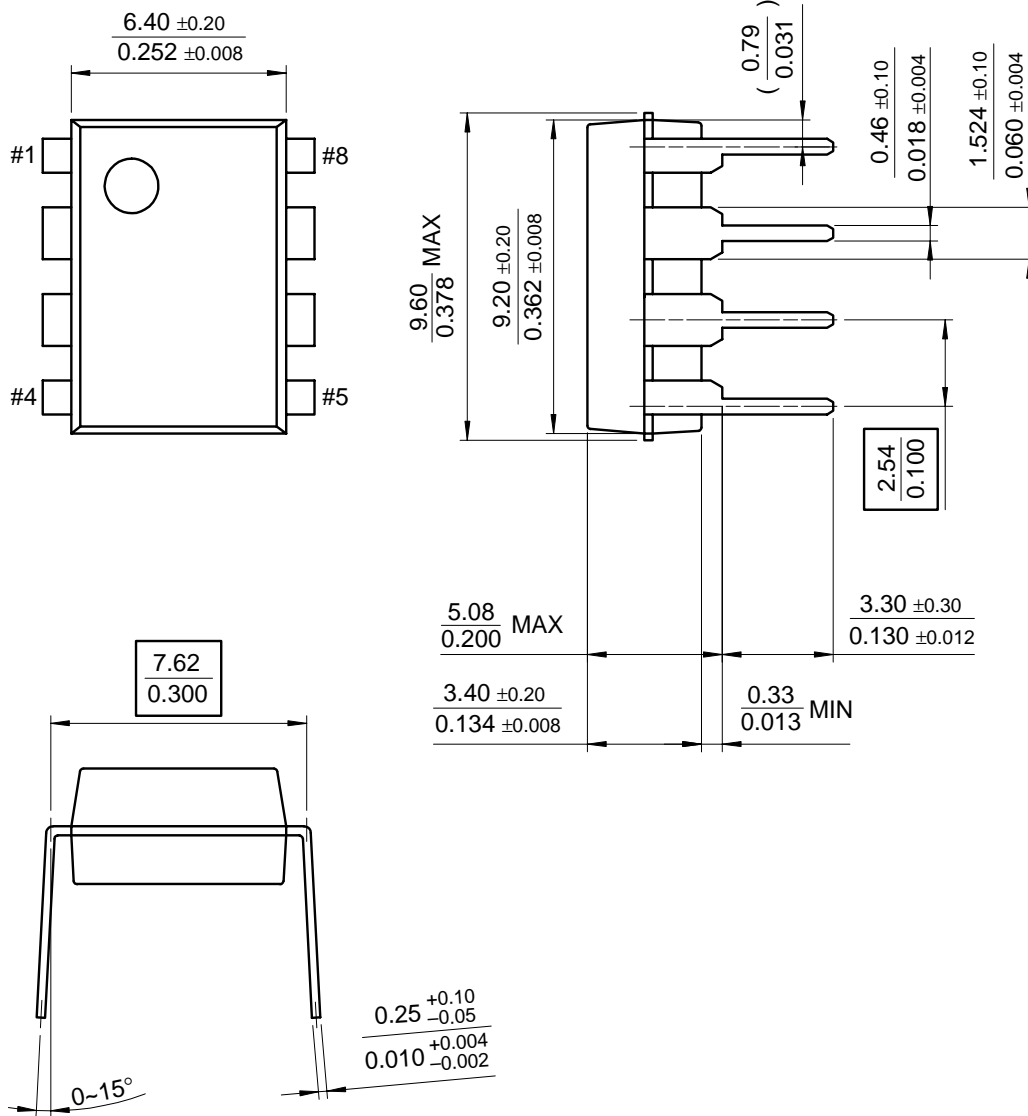

## Ordering Information

Product Number	Output Voltage Tolerance	Package	Operating Temperature	
LM431CCZ	0.5%	TO-92	-25 ~ +85°C	
LM431CCM		8-SOP		
LM431BCZ	1%	TO-92		
LM431BCM		8-SOP		
LM431ACN	2%	8-DIP		
LM431ACZ		TO-92		
LM431ACM		8-SOP		
LM431CIZ	0.5%	TO-92		-40 ~ +85°C
LM431CIM		8-SOP		
LM431BIZ	1%	TO-92		
LM431BIM		8-SOP		
LM431AIZ	2%	TO-92		
LM431AIM		8-SOP		

**DISCLAIMER**

FAIRCHILD SEMICONDUCTOR RESERVES THE RIGHT TO MAKE CHANGES WITHOUT FURTHER NOTICE TO ANY PRODUCTS HEREIN TO IMPROVE RELIABILITY, FUNCTION OR DESIGN. FAIRCHILD DOES NOT ASSUME ANY LIABILITY ARISING OUT OF THE APPLICATION OR USE OF ANY PRODUCT OR CIRCUIT DESCRIBED HEREIN; NEITHER DOES IT CONVEY ANY LICENSE UNDER ITS PATENT RIGHTS, NOR THE RIGHTS OF OTHERS.

**LIFE SUPPORT POLICY**

FAIRCHILD'S PRODUCTS ARE NOT AUTHORIZED FOR USE AS CRITICAL COMPONENTS IN LIFE SUPPORT DEVICES OR SYSTEMS WITHOUT THE EXPRESS WRITTEN APPROVAL OF THE PRESIDENT OF FAIRCHILD SEMICONDUCTOR CORPORATION. As used herein:

1. Life support devices or systems are devices or systems which, (a) are intended for surgical implant into the body, or (b) support or sustain life, and (c) whose failure to perform when properly used in accordance with instructions for use provided in the labeling, can be reasonably expected to result in a significant injury of the user.
2. A critical component in any component of a life support device or system whose failure to perform can be reasonably expected to cause the failure of the life support device or system, or to affect its safety or effectiveness.