

MC4558

Dual Operational Amplifier

Features

- No frequency compensation required.
- No latch up.
- Large common mode and differential voltage range.
- Parameter tracking over temperature range.
- Gain and phase match between amplifiers.
- Internally frequency compensated.
- Low noise input transistors.

Descriptions

The MC4558 series is a monolithic integrated circuit designed for dual operational amplifier.

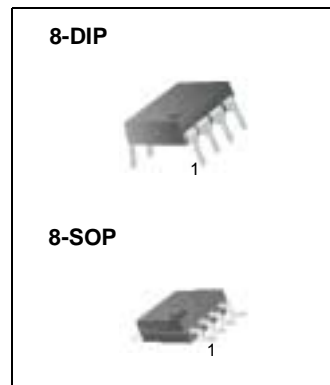

Internal Block Diagram

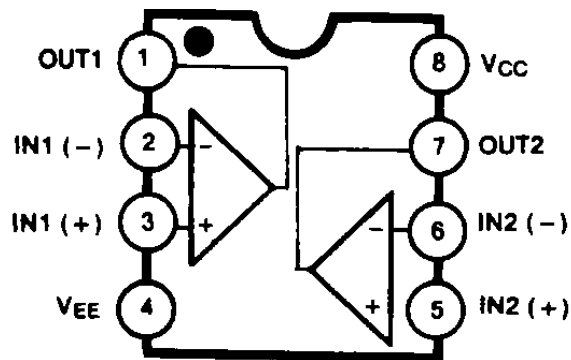

Schematic Diagram

(One Section Only)

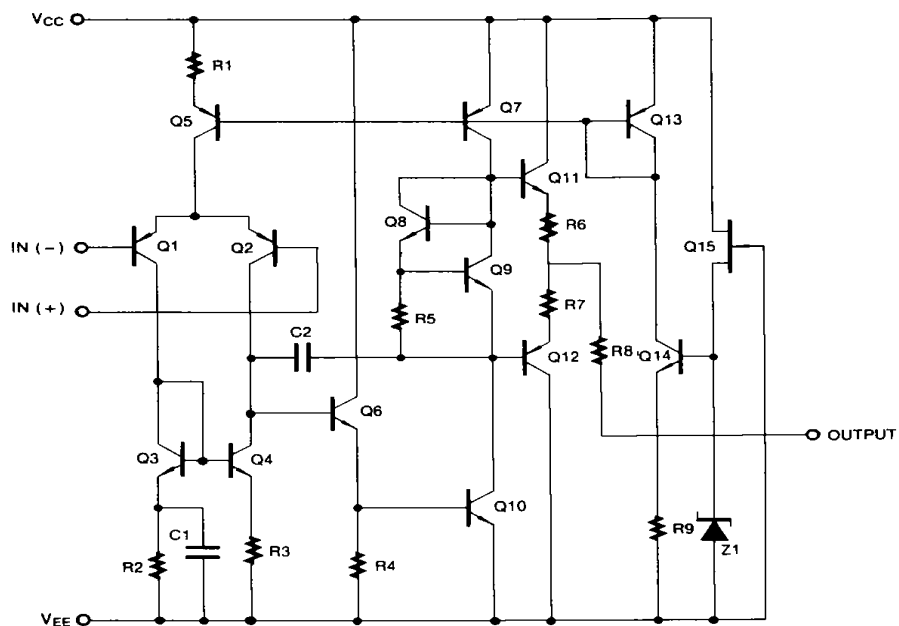

Absolute Maximum Ratings

Parameter	Symbol	Value	Unit
Supply Voltage	V _{CC}	±22	V
Differential Input Voltage	V _{I(DIFF)}	30	V
Input Voltage	V _I	±15	V
Power Dissipation	P _D	400	mW
Operating Temperature Range MC4558C MC4558V	T _{OPR}	0 ~ 70 -40 ~ 85	°C
Storage Temperature Range	T _{STG}	-65 ~ 150	°C

Electrical Characteristics

(VCC = 15V, VEE = -15V, TA = 25 °C unless otherwise specified)

Parameter	Symbol	Conditions	MC4558C/MC4558V			Unit
			Min	Typ	Max	
Input Offset Voltage	V _{IO}	R _S ≤ 10KΩ Note 1	-	2	6	mV
			-	-	7.5	
Input Offset Current	I _{IO}	TA = TA(MAX) TA = TA(MIN)	-	5	200	nA
			-	-	300	
Input Bias Current	I _{BIAS}	TA = TA(MAX) TA = TA(MIN)	-	30	500	nA
			-	-	800	
Large Signal Voltage Gain	G _V	V _{O(P-P)} = ±10V, R _L ≤ 2KΩ Note 1	20	200	-	V/mV
			-	-	-	
Common Mode Input Voltage Range	V _{I(R)}	Note 1	±12	±13	-	V
			-	-	-	
Common Mode Rejection Ratio	CMRR	R _S ≤ 10KΩ Note 1	70	90	-	dB
			-	-	-	
Supply Voltage Rejection Ratio	PSRR	R _S ≤ 10KΩ Note 1	76	90	-	dB
			76	90	-	
Output Voltage Swing	V _{O(P,P)}	R _L ≥ 10KΩ	±12	±14	-	V
		R _L ≥ 2KΩ	±10	±13	-	
Supply Current (Both Amplifiers)	I _{CC}	TA = TA(MAX) TA = TA(MIN)	-	3.5	5.8	mA
			-	-	5.0	
Power Consumption (Both Amplifiers)	P _C	TA = TA(MAX) Ta = TA(MIN)	-	70	170	mW
			-	-	150	
Slew Rate (Note2)	SR	V _I = 10V, R _L ≥ 2KΩ C _I ≤ 100pF	1.2	-	-	V/μs
Rise Time (Note2)	T _R	V _I = 20mV, R _L ≥ 2KΩ C _I ≤ 100pF	-	0.3	-	μs
Overshoot (Note2)	OS	V _I = 20mV, R _L ≥ 2KΩ C _I ≤ 100pF	-	15	-	%

Note :

- MC4558C : TA(MIN) ≤ TA ≤ TA(MAX) = 0 ≤ TA ≤ 70 °C , MC4558V : TA(MIN) ≤ TA ≤ TA(MAX) = -40 ≤ TA ≤ +85 °C
- Guaranteed by design.

Typical Performance Characteristics

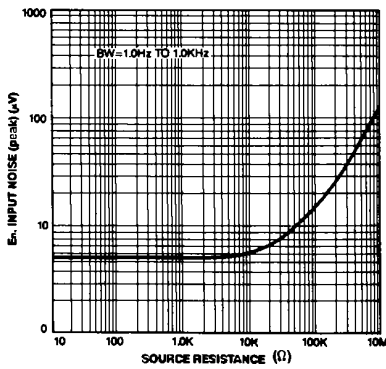

Figure 1. Burst Noise vs Source Resistance

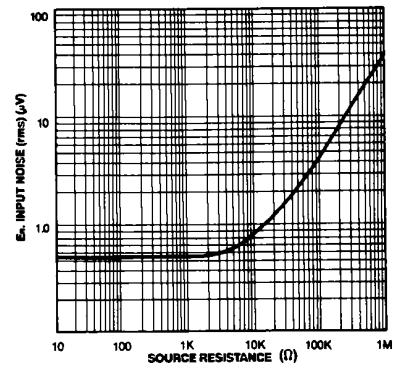

Figure 2. RMS Noise vs Source Resistance

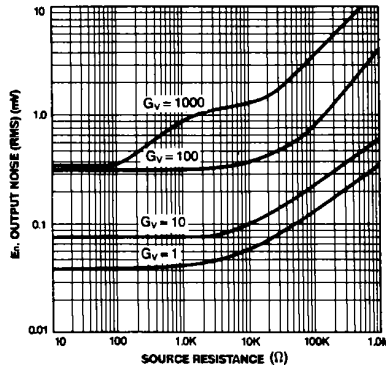

Figure 3. Output Noise vs Source Resistance

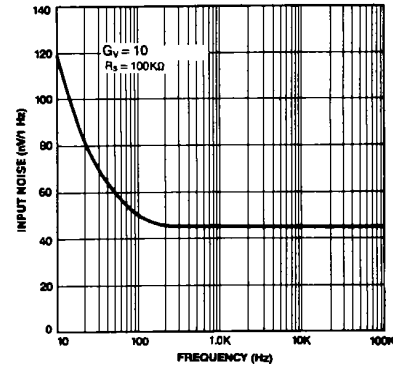

Figure 4. Spectral Noise Density

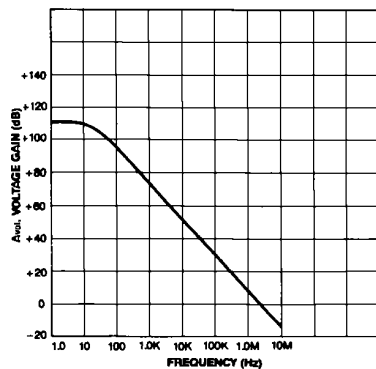

Figure 5. Open Loop Frequency Response

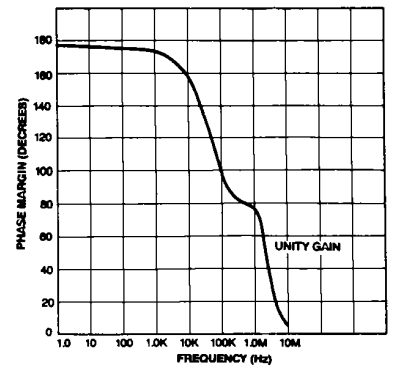

Figure 6. Phase Margin vs Frequency

Typical Performance Characteristics (continued)

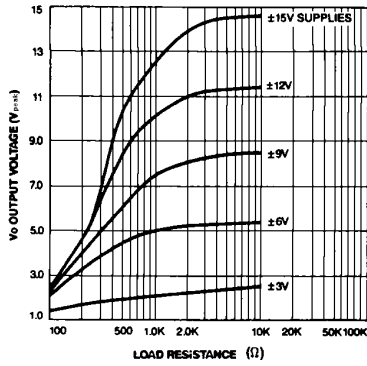

Figure 7. Positive Output Voltage Swing vs Load Resistance

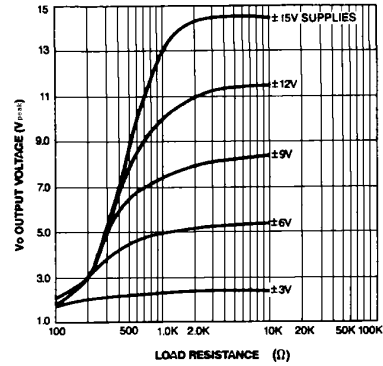

Figure 8. Negative Output Voltage Swing vs Load Resistance

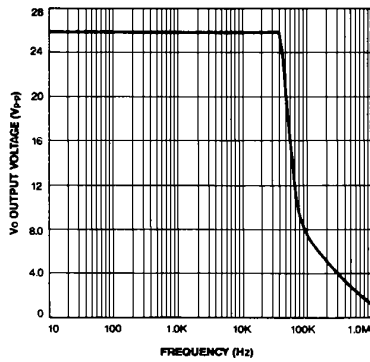
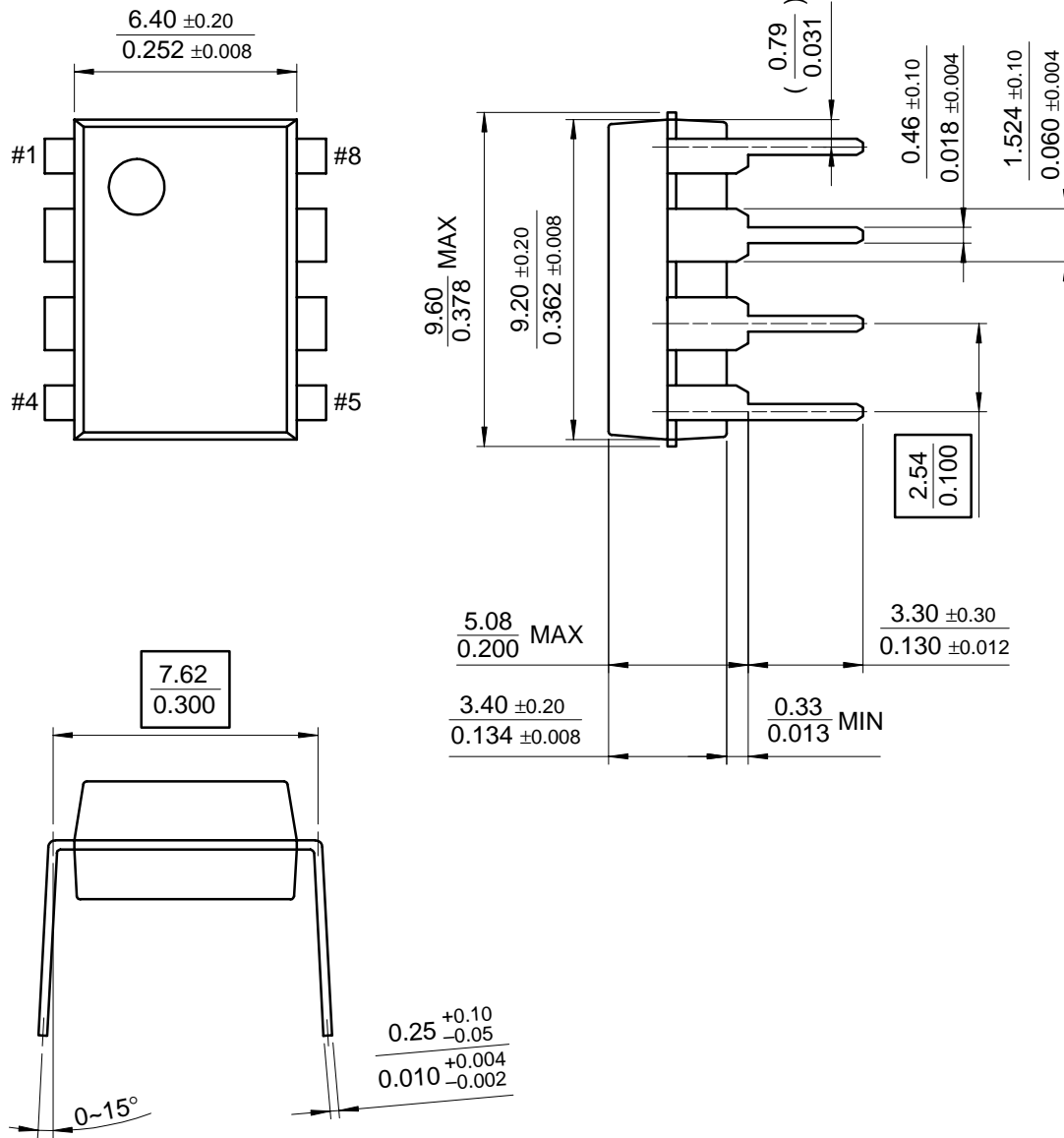

Figure 9. Power Bandwidth (Large Signal Output Swing vs Frequency)

Mechanical Dimensions

Package

8-DIP



Mechanical Dimensions (Continued)

Package

8-SOP

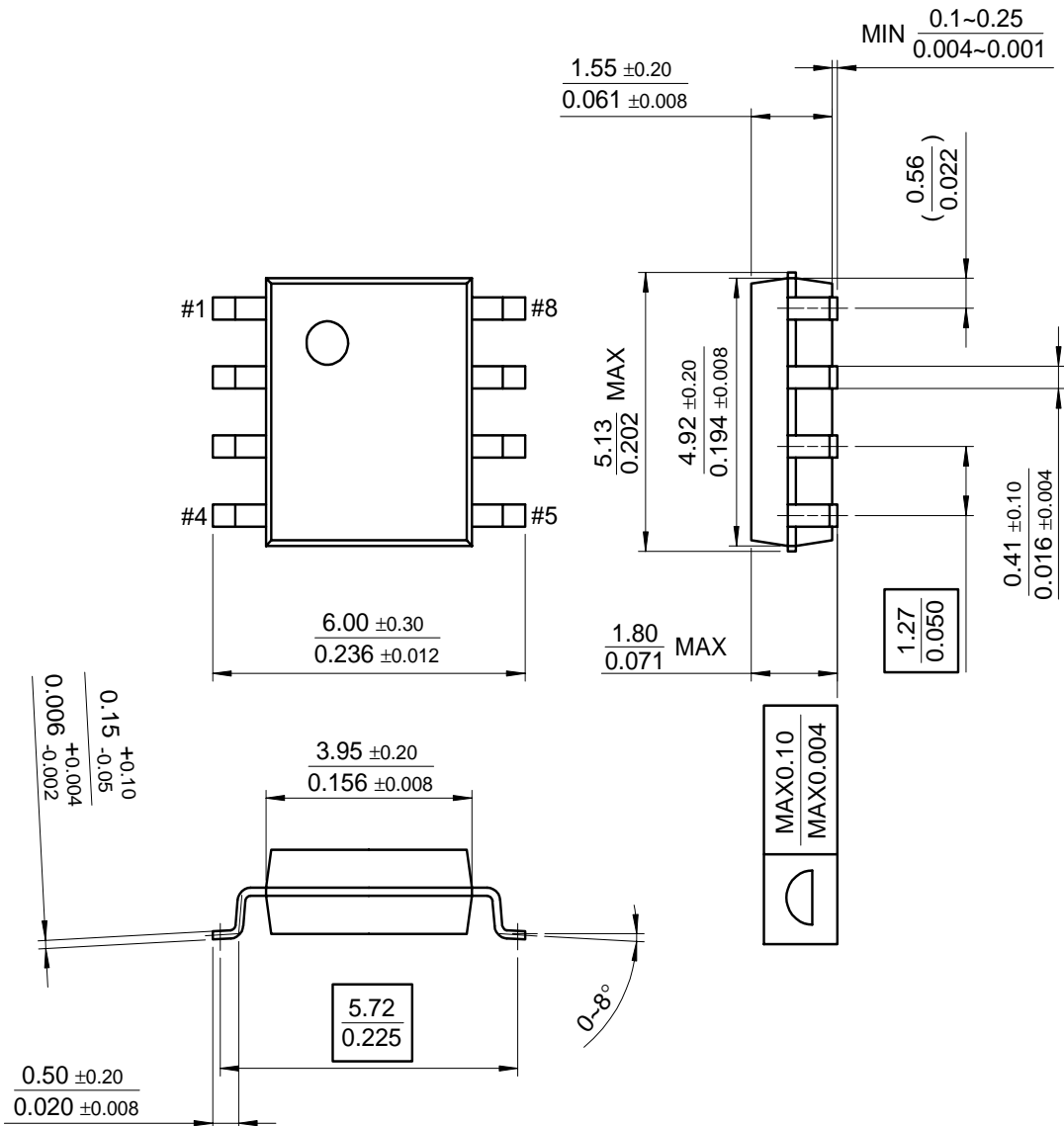

Ordering Information

Product Number	Package	Operating Temperature
MC4558CP	8-DIP	0 ~ + 70°C
MC4558CD	8-SOP	
MC4558VP	8-DIP	-40 ~ +85°C
MC4558VD	8-SOP	

DISCLAIMER

FAIRCHILD SEMICONDUCTOR RESERVES THE RIGHT TO MAKE CHANGES WITHOUT FURTHER NOTICE TO ANY PRODUCTS HEREIN TO IMPROVE RELIABILITY, FUNCTION OR DESIGN. FAIRCHILD DOES NOT ASSUME ANY LIABILITY ARISING OUT OF THE APPLICATION OR USE OF ANY PRODUCT OR CIRCUIT DESCRIBED HEREIN; NEITHER DOES IT CONVEY ANY LICENSE UNDER ITS PATENT RIGHTS, NOR THE RIGHTS OF OTHERS.

LIFE SUPPORT POLICY

FAIRCHILD'S PRODUCTS ARE NOT AUTHORIZED FOR USE AS CRITICAL COMPONENTS IN LIFE SUPPORT DEVICES OR SYSTEMS WITHOUT THE EXPRESS WRITTEN APPROVAL OF THE PRESIDENT OF FAIRCHILD SEMICONDUCTOR CORPORATION. As used herein:

1. Life support devices or systems are devices or systems which, (a) are intended for surgical implant into the body, or (b) support or sustain life, and (c) whose failure to perform when properly used in accordance with instructions for use provided in the labeling, can be reasonably expected to result in a significant injury of the user.
2. A critical component in any component of a life support device or system whose failure to perform can be reasonably expected to cause the failure of the life support device or system, or to affect its safety or effectiveness.