

NC7NZU04 TinyLogic® UHS Unbuffered Inverter

General Description

The NC7NZU04 is a triple unbuffered inverter from Fairchild's Ultra High Speed Series of TinyLogic®. The special purpose unbuffered circuit design is primarily intended for crystal oscillator or analog applications. The device is fabricated with advanced CMOS technology to achieve ultra high speed with high output drive while maintaining low static power dissipation over a very broad V_{CC} operating range. The device is specified to operate over the 1.65V to 5.5V V_{CC} range.

Features

- Space saving US8 surface mount package
- MicroPak™ Pb-Free leadless package
- Unbuffered for crystal oscillator and analog applications
- Balanced Output Drive; ± 8 mA at 4.5V V_{CC}
- Broad V_{CC} Operating Range: 1.65V to 5.5V
- Low Quiescent Power;
 $I_{CC} < 1 \mu A$, $V_{CC} = 5.5V$, $T_A = 25^\circ C$

Ordering Code:

| Order Number | Package Number | Product Code Top Mark | Package Description | Supplied As |
|--------------|----------------|-----------------------|---|---------------------------|
| NC7NZU04K8X | MAB08A | 7NZU4 | 8-Lead US8, JEDEC MO-187, Variation CA 3.1mm Wide | 3k Units on Tape and Reel |
| NC7NZU04L8X | MAC08A | U6 | Pb-Free 8-Lead MicroPak, 1.6 mm Wide | 5k Units on Tape and Reel |

Pb-Free package per JEDEC J-STD-020B.

Logic Symbol

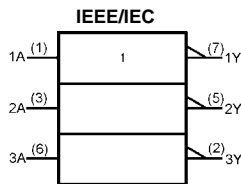

Pin Descriptions

| Pin Names | Description |
|-----------|-------------|
| A | Input |
| Y | Output |

Function Table

$$Y = \bar{A}$$

| Input | Output |
|-------|--------|
| A | Y |
| L | H |
| H | L |

H = HIGH Logic Level
L = LOW Logic Level

Connection Diagrams

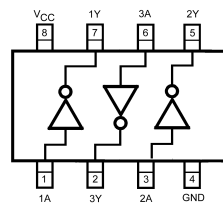

(Top View)

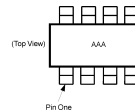

AAA represents Product Code Top Mark - see ordering code

Note: Orientation of Top Mark determines Pin One location. Read the Top Product Code Mark left to right, Pin One is the lower left pin (see diagram).

Pad Assignment for MicroPak

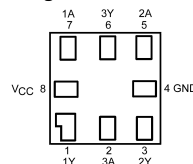

(Top Thru View)

Absolute Maximum Ratings(Note 1)

| | |
|---|-----------------|
| Supply Voltage (V_{CC}) | -0.5V to +7V |
| DC Input Voltage (V_{IN}) | -0.5V to +7V |
| DC Output Voltage (V_{OUT}) | -0.5V to +7V |
| DC Input Diode Current (I_{IK}) | |
| @ $V_{IN} < -0.5V$ | -50 mA |
| @ $V_{IN} > V_{CC} + 0.5V$ | +20 mA |
| DC Output Diode Current (I_{OK}) | |
| @ $V_{OUT} < -0.5V$ | -50 mA |
| @ $V_{OUT} > 0.5V, V_{CC} = GND$ | +50 mA |
| DC Output Current (I_{OUT}) | ±50 mA |
| DC V_{CC}/GND Current (I_{CC}/I_{GND}) | ±100 mA |
| Storage Temperature (T_{STG}) | -65°C to +150°C |
| Junction Temperature under Bias (T_J) | 150°C |
| Junction Lead Temperature (T_L); (Soldering, 10 seconds) | 260°C |
| Power Dissipation (P_D) @ +85°C | 250 mW |

Recommended Operating Conditions (Note 2)

| | |
|--|----------------|
| Supply Voltage Operating (V_{CC}) | 1.65V to 5.5V |
| Supply Voltage Data Retention (V_{CC}) | 1.5V to 5.5V |
| Input Voltage (V_{IN}) | 0V to 5.5V |
| Output Voltage (V_{OUT}) | 0V to V_{CC} |
| Operating Temperature (T_A) | -40°C to +85°C |
| Thermal Resistance (θ_{JA}) | 250°C/W |

Note 1: Absolute maximum ratings are DC values beyond which the device may be damaged or have its useful life impaired. The datasheet specifications should be met, without exception, to ensure that the system design is reliable over its power supply, temperature, and output/input loading variables. Fairchild does not recommend operation outside datasheet specifications.

Note 2: Unused inputs must be held HIGH or LOW. They may not float.

DC Electrical Characteristics

| Symbol | Parameter | V_{CC} (V) | $T_A = +25^\circ C$ | | | $T_A = -40^\circ C$ to $+85^\circ C$ | | Units | Conditions | | | |
|--------------|---|---------------------------|-------------------------------|------|-------------------------------|--------------------------------------|-------------------------------|-------|--|-----------------------|--|---|
| | | | Min | Typ | Max | Min | Max | | | | | |
| V_{IH} | HIGH Level Input Voltage | 1.65 to 2.7 3.0 to 5.5 | 0.85 V_{CC} 0.8 V_{CC} | | | 0.85 V_{CC} 0.8 V_{CC} | | V | | | | |
| V_{IL} | LOW Level Input Voltage | 1.65 to 2.7 3.0 to 5.5 | | | 0.15 V_{CC} 0.2 V_{CC} | | 0.15 V_{CC} 0.2 V_{CC} | V | | | | |
| V_{OH} | HIGH Level Output Voltage | 1.65 | 1.55 | 1.65 | | 1.55 | | V | $V_{IN} = V_{IL}$ | $I_{OH} = -100 \mu A$ | | |
| | | 2.3 | 2.1 | 2.3 | | 2.1 | | | | | | |
| | | 3.0 | 2.7 | 3.0 | | 2.7 | | | | | | |
| | | 4.5 | 4.0 | 4.4 | | 4.0 | | | | | | |
| | | | | 1.65 | 1.29 | 1.52 | | 1.29 | V | $V_{IN} = GND$ | $I_{OH} = -2 \text{ mA}$ $I_{OH} = -2 \text{ mA}$ $I_{OH} = -4 \text{ mA}$ $I_{OH} = -6 \text{ mA}$ $I_{OH} = -8 \text{ mA}$ | |
| | | | | 2.3 | 1.9 | 2.14 | | 1.9 | | | | |
| | | | | 3.0 | 2.4 | 2.75 | | 2.4 | | | | |
| | | | | 3.0 | 2.3 | 2.61 | | 2.3 | | | | |
| | | 4.5 | 3.8 | 4.13 | | 3.8 | | | | | | |
| V_{OL} | LOW Level Output Voltage | 1.65 | | 0.0 | 0.2 | | 0.2 | V | $V_{IN} = V_{IH}$ | $I_{OL} = 100 \mu A$ | | |
| | | 2.3 | | 0.0 | 0.2 | | 0.2 | | | | | |
| | | 3.0 | | 0.0 | 0.3 | | 0.3 | | | | | |
| | | 4.5 | | 0.0 | 0.5 | | 0.5 | | | | | |
| | | | | 1.65 | | 0.08 | 0.24 | | 0.24 | V | $V_{IN} = V_{CC}$ | $I_{OL} = 2 \text{ mA}$ $I_{OL} = 2 \text{ mA}$ $I_{OL} = 4 \text{ mA}$ $I_{OL} = 6 \text{ mA}$ $I_{OL} = 8 \text{ mA}$ |
| | | | | 2.3 | | 0.10 | 0.3 | | 0.3 | | | |
| | | | | 3.0 | | 0.17 | 0.4 | | 0.4 | | | |
| | | | | 3.0 | | 0.25 | 0.55 | | 0.55 | | | |
| | | 4.5 | | 0.26 | 0.55 | | 0.55 | | | | | |
| I_{IN} | Input Leakage Current | 0 to 5.5 | | | ±0.1 | | ±1.0 | μA | $V_{IN} = 5.5V, GND$ | | | |
| I_{CC} | Quiescent Supply Current | 1.65 to 5.5 | | | 1 | | 10 | μA | $V_{IN} = 5.5V, GND$ | | | |
| I_{CCPEAK} | Peak Supply Current in Analog Operation | 1.8 | | | 1 | | | mA | $V_{OUT} = \text{Open}$ $V_{IN} = \text{Adjust for Peak } I_{CC} \text{ Current}$ | | | |
| | | 2.5 | | | 2 | | | | | | | |
| | | 3.3 | | | 5 | | | | | | | |
| | | 5.0 | | | 15 | | | | | | | |

AC Electrical Characteristics

| Symbol | Parameter | V _{CC} (V) | T _A = +25°C | | | T _A = -40°C to +85°C | | Units | Conditions | Figure Number |
|------------------|-------------------|------------------------|------------------------|-----|-----|---------------------------------|-----|-------|--|-----------------|
| | | | Min | Typ | Max | Min | Max | | | |
| t _{PLH} | Propagation Delay | 1.8 ± 0.05 | 1.0 | | 8.5 | 1.0 | 9.0 | ns | C _L = 15 pF, R _L = 1 MΩ | Figures 1, 3 |
| t _{PHL} | | 2.5 ± 0.2 | 0.8 | | 6.2 | 0.8 | 6.5 | | | |
| | | 3.3 ± 0.3 | 0.5 | | 4.5 | 0.5 | 4.8 | | | |
| | | 5.0 ± 0.5 | 0.5 | | 3.9 | 0.5 | 4.1 | | | |
| t _{PLH} | Propagation Delay | 3.3 ± 0.3 | 1.0 | | 6.0 | 1.0 | 6.5 | ns | C _L = 50 pF, R _L = 500Ω | Figures 1, 3 |
| t _{PHL} | | 5.0 ± 0.5 | 0.8 | | 5.0 | 0.8 | 5.5 | | | |
| C _{IN} | Input Capacitance | 0 | 2.5 | | | | | pF | | |
| C _{PD} | Power Dissipation | 3.3 | 9 | | | | | pF | (Note 3) | Figure 2 |
| | Capacitance | 5.0 | 11 | | | | | | | |

Note 3: C_{PD} is defined as the value of the internal equivalent capacitance which is derived from dynamic operating current consumption (I_{CCD}) at no output loading and operating at 50% duty cycle. (See Figure 2.) C_{PD} is related to I_{CCD} dynamic operating current by the expression:
I_{CCD} = (C_{PD})(V_{CC})(f_{IN}) + (I_{CC}static).

Dynamic Switching Characteristics

| Symbol | Parameter | Conditions | V _{CC} (V) | T _A = 25°C | Unit |
|------------------|---|---|------------------------|-----------------------|------|
| | | | | Typical | |
| V _{OLP} | Quiet Output Dynamic Peak V _{OL} | C _L = 50pF, V _{IH} = 5.0V, V _{IL} = 0V | 5.0 | 0.8 | V |
| V _{OLV} | Quiet Output Dynamic Valley V _{OL} | C _L = 50pF, V _{IH} = 5.0V, V _{IL} = 0V | 5.0 | -0.8 | V |

AC Loading and Waveforms

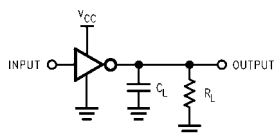

C_L includes load and stray capacitance
Input PRR = 1.0 MHz; t_W = 500 ns

FIGURE 1. AC Test Circuit

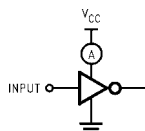

Application Note: When operating the NC7NZU04's unbuffered output stage in its linear range, as in oscillator applications, care must be taken to observe maximum power rating for the device and package. The high drive nature of the design of the output stage will result in substantial simultaneous conduction currents when the stage is in the linear region. See the I_{CCPEAK} specification in the DC Electrical Characteristics table.

Input = AC Waveform; t_r = t_f = 1.8 ns;
PRR = variable; Duty Cycle = 50%

FIGURE 2. I_{CCD} Test Circuit

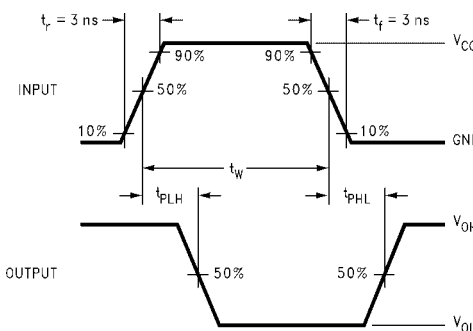

FIGURE 3. AC Waveforms

Tape and Reel Specification

TAPE FORMAT for US8

| Package Designator | Tape Section | Number Cavities | Cavity Status | Cover Tape Status |
|--------------------|--------------------|-----------------|---------------|-------------------|
| K8X | Leader (Start End) | 125 (typ) | Empty | Sealed |
| | Carrier | 3000 | Filled | Sealed |
| | Trailer (Hub End) | 75 (typ) | Empty | Sealed |

TAPE DIMENSIONS inches (millimeters)

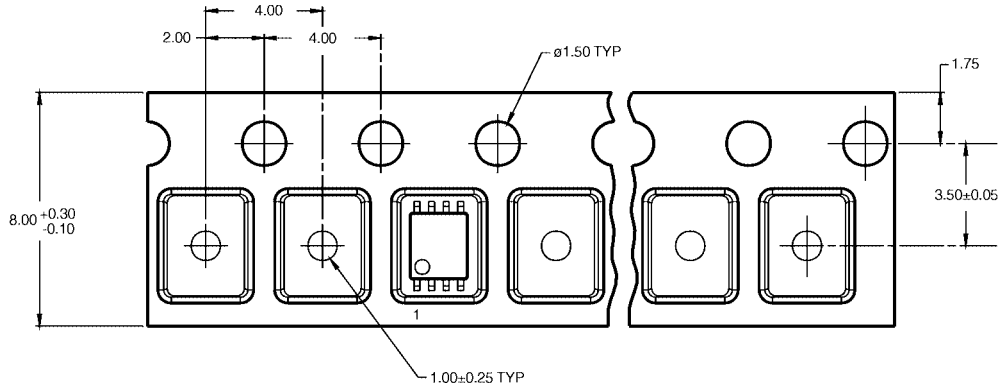

TAPE FORMAT for MicroPak

| Package Designator | Tape Section | Number Cavities | Cavity Status | Cover Tape Status |
|--------------------|--------------------|-----------------|---------------|-------------------|
| L8X | Leader (Start End) | 125 (typ) | Empty | Sealed |
| | Carrier | 3000 | Filled | Sealed |
| | Trailer (Hub End) | 75 (typ) | Empty | Sealed |

TAPE DIMENSIONS inches (millimeters)

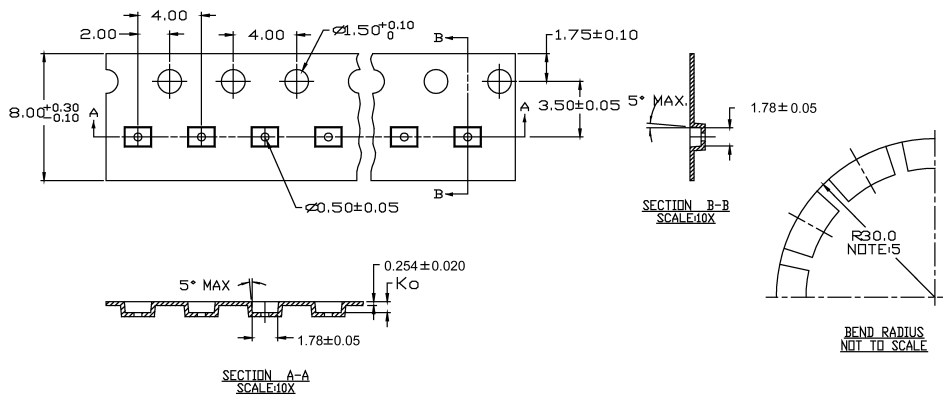

Tape and Reel Specification (Continued)
REEL DIMENSIONS inches (millimeters)

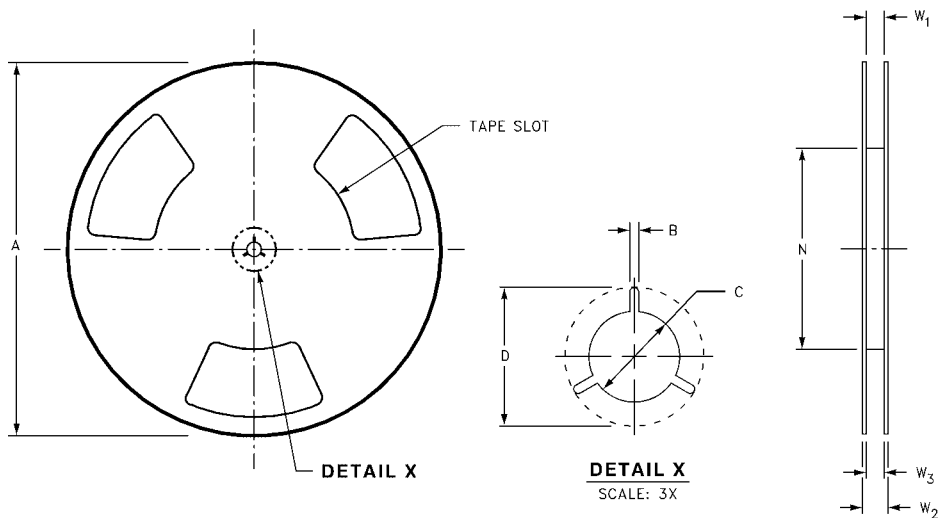

| Tape Size | A | B | C | D | N | W1 | W2 | W3 |
|-----------|----------------|-----------------|------------------|------------------|------------------|--|------------------|--|
| 8 mm | 7.0 (177.8) | 0.059 (1.50) | 0.512 (13.00) | 0.795 (20.20) | 2.165 (55.00) | 0.331 + 0.059/-0.000 (8.40 + 1.5/-0.00) | 0.567 (14.40) | W1 + 0.078/-0.039 (W1 + 2.00/-1.00) |

Physical Dimensions inches (millimeters) unless otherwise noted

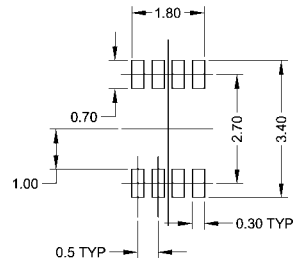
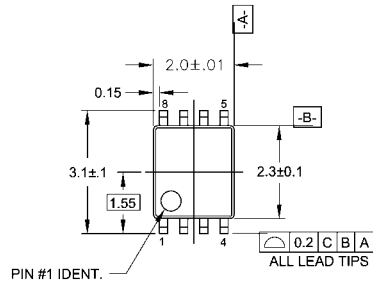

LAND PATTERN RECOMMENDATION

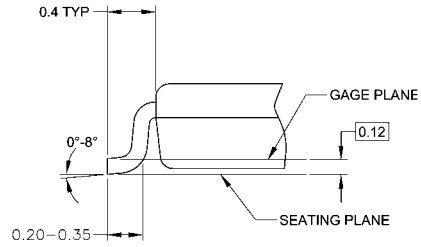
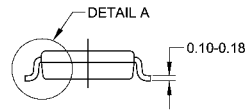
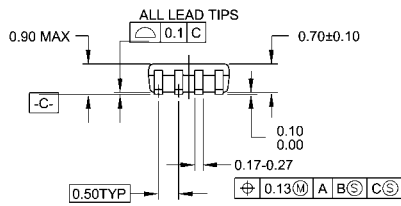

NOTES:

- A. CONFORMS TO JEDEC REGISTRATION MO-187
- B. DIMENSIONS ARE IN MILLIMETERS.
- C. DIMENSIONS ARE EXCLUSIVE OF BURRS, MOLD FLASH, AND TIE BAR EXTRUSIONS.
- D. DIMENSIONS AND TOLERANCES PER ANSI Y14.5M, 1982.

MAB08AREVC

**8-Lead US8, JEDEC MO-187, Variation CA 3.1mm Wide
Package Number MAB08A**

Physical Dimensions inches (millimeters) unless otherwise noted (Continued)

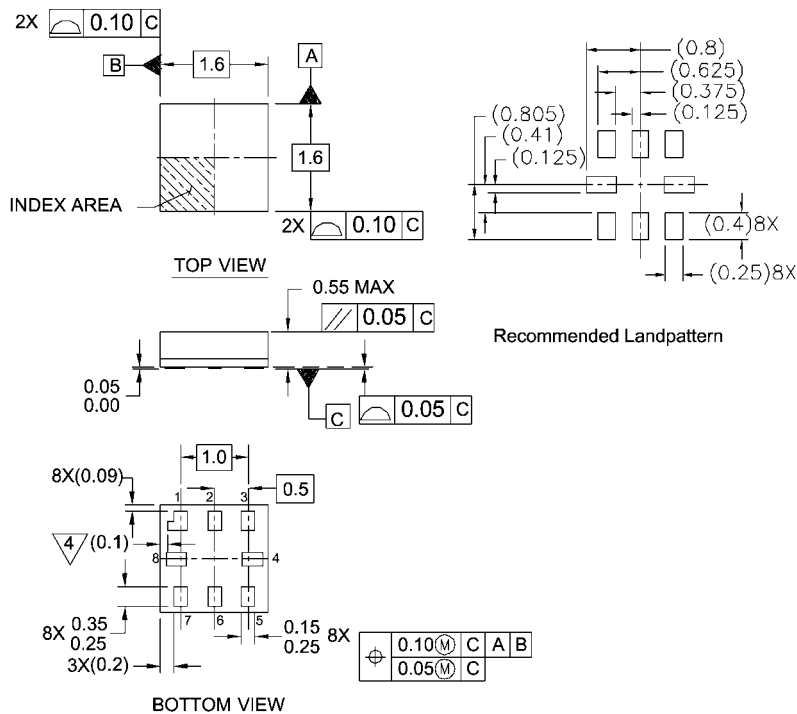

Notes:

1. PACKAGE CONFORMS TO JEDEC MO-255 VARIATION UAAD
2. DIMENSIONS ARE IN MILLIMETERS
3. DRAWING CONFORMS TO ASME Y.14M-1994
4. PIN 1 FLAG, END OF PACKAGE OFFSET.

MAC08AREVC

**Pb-Free 8-Lead MicroPak, 1.6 mm Wide
Package Number MAC08A**

Fairchild does not assume any responsibility for use of any circuitry described, no circuit patent licenses are implied and Fairchild reserves the right at any time without notice to change said circuitry and specifications.

LIFE SUPPORT POLICY

FAIRCHILD'S PRODUCTS ARE NOT AUTHORIZED FOR USE AS CRITICAL COMPONENTS IN LIFE SUPPORT DEVICES OR SYSTEMS WITHOUT THE EXPRESS WRITTEN APPROVAL OF THE PRESIDENT OF FAIRCHILD SEMICONDUCTOR CORPORATION. As used herein:

1. Life support devices or systems are devices or systems which, (a) are intended for surgical implant into the body, or (b) support or sustain life, and (c) whose failure to perform when properly used in accordance with instructions for use provided in the labeling, can be reasonably expected to result in a significant injury to the user.
2. A critical component in any component of a life support device or system whose failure to perform can be reasonably expected to cause the failure of the life support device or system, or to affect its safety or effectiveness.

www.fairchildsemi.com