

NDS9952A Dual N & P-Channel Enhancement Mode Field Effect Transistor

General Description

These dual N- and P-channel enhancement mode power field effect transistors are produced using Fairchild's proprietary, high cell density, DMOS technology. This very high density process is especially tailored to minimize on-state resistance, provide superior switching performance, and withstand high energy pulses in the avalanche and commutation modes. These devices are particularly suited for low voltage applications such as notebook computer power management and other battery powered circuits where fast switching, low in-line power loss, and resistance to transients are needed.

Features

- N-Channel 3.7A, 30V, $R_{DS(ON)}=0.08\Omega @ V_{GS}=10V$.
P-Channel -2.9A, -30V, $R_{DS(ON)}=0.13\Omega @ V_{GS}=-10V$.
- High density cell design or extremely low $R_{DS(ON)}$.
- High power and current handling capability in a widely used surface mount package.
- Dual (N & P-Channel) MOSFET in surface mount package.

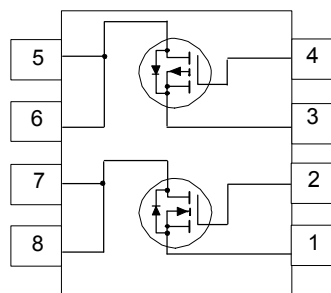
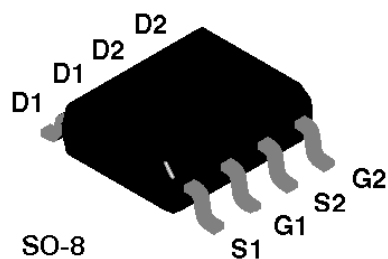

Absolute Maximum Ratings $T_A = 25^\circ\text{C}$ unless otherwise noted

Symbol	Parameter	N-Channel	P-Channel	Units
V_{DSS}	Drain-Source Voltage	30	-30	V
V_{GSS}	Gate-Source Voltage	± 20	± 20	V
I_D	Drain Current - Continuous (Note 1a)	± 3.7	± 2.9	A
	- Pulsed	± 15	± 10	
P_D	Power Dissipation for Dual Operation	2		W
	Power Dissipation for Single Operation (Note 1a)	1.6		
	(Note 1b)	1		
	(Note 1c)	0.9		
T_J, T_{STG}	Operating and Storage Temperature Range	-55 to 150		$^\circ\text{C}$

THERMAL CHARACTERISTICS

$R_{\theta JA}$	Thermal Resistance, Junction-to-Ambient (Note 1a)	78	$^\circ\text{C/W}$
$R_{\theta JC}$	Thermal Resistance, Junction-to-Case (Note 1)	40	$^\circ\text{C/W}$

Electrical Characteristics ($T_A = 25^\circ\text{C}$ unless otherwise noted)

Symbol	Parameter	Conditions	Type	Min	Typ	Max	Units	
OFF CHARACTERISTICS								
BV_{DSS}	Drain-Source Breakdown Voltage	$V_{GS} = 0\text{ V}, I_D = 250\ \mu\text{A}$	N-Ch	30			V	
		$V_{GS} = 0\text{ V}, I_D = -250\ \mu\text{A}$	P-Ch	-30			V	
I_{DSS}	Zero Gate Voltage Drain Current	$V_{DS} = 24\text{ V}, V_{GS} = 0\text{ V}$	N-Ch			2	μA	
				$T_J = 55^\circ\text{C}$			25	μA
		$V_{DS} = -24\text{ V}, V_{GS} = 0\text{ V}$	P-Ch			-2	μA	
				$T_J = 55^\circ\text{C}$			-25	μA
I_{GSSF}	Gate - Body Leakage, Forward	$V_{GS} = 20\text{ V}, V_{DS} = 0\text{ V}$	All			100	nA	
I_{GSSR}	Gate - Body Leakage, Reverse	$V_{GS} = -20\text{ V}, V_{DS} = 0\text{ V}$	All			-100	nA	
ON CHARACTERISTICS (Note 2)								
$V_{GS(th)}$	Gate Threshold Voltage	$V_{DS} = V_{GS}, I_D = 250\ \mu\text{A}$	N-Ch	1	1.7	2.8	V	
				$T_J = 125^\circ\text{C}$	0.7	1.2		2.2
		$V_{DS} = V_{GS}, I_D = -250\ \mu\text{A}$	P-Ch	-1	-1.6	-2.8		
				$T_J = 125^\circ\text{C}$	-0.85	-1.25		-2.5
$R_{DS(on)}$	Static Drain-Source On-Resistance	$V_{GS} = 10\text{ V}, I_D = 1.0\text{ A}$	N-Ch		0.06	0.08	Ω	
				$T_J = 125^\circ\text{C}$		0.08		0.13
		$V_{GS} = 4.5\text{ V}, I_D = 0.5\text{ A}$	N-Ch		0.08	0.11		
				$T_J = 125^\circ\text{C}$		0.11		0.18
		$V_{GS} = -10\text{ V}, I_D = -1.0\text{ A}$	P-Ch		0.11	0.13		
				$T_J = 125^\circ\text{C}$		0.15		0.21
$V_{GS} = -4.5\text{ V}, I_D = -0.5\text{ A}$		0.17	0.2					
	$T_J = 125^\circ\text{C}$		0.24	0.32				
$I_{D(on)}$	On-State Drain Current	$V_{GS} = 10\text{ V}, V_{DS} = 5\text{ V}$	N-Ch	15			A	
		$V_{GS} = -10\text{ V}, V_{DS} = -5\text{ V}$	P-Ch	-10				
g_{FS}	Forward Transconductance	$V_{DS} = 15\text{ V}, I_D = 3.7\text{ A}$	N-Ch		6		S	
		$V_{DS} = -15\text{ V}, I_D = -2.9\text{ A}$	P-Ch		4			
DYNAMIC CHARACTERISTICS								
C_{iss}	Input Capacitance	N-Channel $V_{DS} = 10\text{ V}, V_{GS} = 0\text{ V},$ $f = 1.0\text{ MHz}$	N-Ch		320		pF	
			P-Ch		350			
C_{oss}	Output Capacitance		P-Channel $V_{DS} = -10\text{ V}, V_{GS} = 0\text{ V},$ $f = 1.0\text{ MHz}$	N-Ch		225		pF
				P-Ch		260		
C_{rss}	Reverse Transfer Capacitance			N-Ch		85		pF
				P-Ch		100		

Electrical Characteristics (T_A = 25°C unless otherwise noted)

Symbol	Parameter	Conditions	Type	Min	Typ	Max	Units	
SWITCHING CHARACTERISTICS (Note 2)								
t _{D(on)}	Turn - On Delay Time	N-Channel V _{DD} = 10 V, I _D = 1 A, V _{GEN} = 10 V, R _{GEN} = 6 Ω	N-Ch		10	15	ns	
			P-Ch		9	40		
t _r	Turn - On Rise Time	P-Channel V _{DD} = -10 V, I _D = -1 A, V _{GEN} = -10 V, R _{GEN} = 6 Ω	N-Ch		13	20	ns	
			P-Ch		21	40		
t _{D(off)}	Turn - Off Delay Time		N-Ch			21	50	ns
				P-Ch		21	90	
t _f	Turn - Off Fall Time	N-Ch			5	50	ns	
			P-Ch		8	50		
Q _g	Total Gate Charge	N-Channel V _{DS} = 10 V, I _D = 3.7 A, V _{GS} = 10 V	N-Ch		9.5	27	nC	
			P-Ch		10	25		
Q _{gs}	Gate-Source Charge	P-Channel V _{DS} = -10 V, I _D = -2.9 A, V _{GS} = -10 V	N-Ch		1.5		nC	
			P-Ch		1.6			
Q _{gd}	Gate-Drain Charge	N-Ch			3.3		nC	
			P-Ch		3.4			

DRAIN-SOURCE DIODE CHARACTERISTICS AND MAXIMUM RATINGS

I _S	Maximum Continuous Drain-Source Diode Forward Current		N-Ch			1.2	A
			P-Ch			-1.2	
V _{SD}	Drain-Source Diode Forward Voltage	V _{GS} = 0 V, I _S = 1.25 A (Note 2)	N-Ch		0.8	1.3	V
		V _{GS} = 0 V, I _S = -1.25 A (Note 2)	P-Ch		-0.8	-1.3	
t _{rr}	Reverse Recovery Time	V _{GS} = 0 V, I _F = 1.25 A, dI _F /dt = 100 A/μs	N-Ch			75	ns
		V _{GS} = 0 V, I _F = -1.25 A, dI _F /dt = 100 A/μs	P-Ch			100	

Notes:

- R_{θJA} is the sum of the junction-to-case and case-to-ambient thermal resistance where the case thermal reference is defined as the solder mounting surface of the drain pins. R_{θJC} is guaranteed by design while R_{θCA} is determined by the user's board design.

$$P_D(t) = \frac{T_J - T_A}{R_{\theta J} \theta} = \frac{T_J - T_A}{R_{\theta J} \theta R_{\theta CA}(t)} = I_D^2(t) \times R_{DS(on)} \theta R_{\theta J}$$

Typical R_{θJA} for single device operation using the board layouts shown below on 4.5"x5" FR-4 PCB in a still air environment:

- 78°C/W when mounted on a 0.5 in² pad of 2oz copper.
- 125°C/W when mounted on a 0.02 in² pad of 2oz copper.
- 135°C/W when mounted on a 0.003 in² pad of 2oz copper.

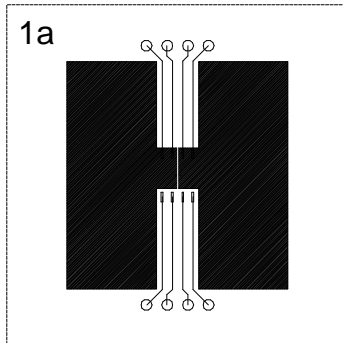

Scale 1 : 1 on letter size paper

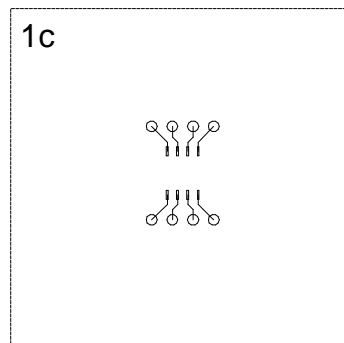
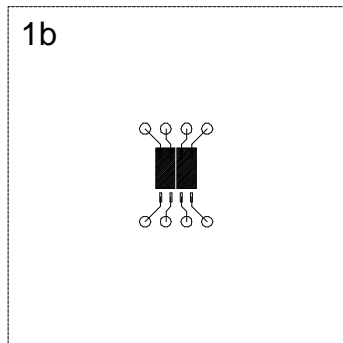

- Pulse Test: Pulse Width ≤ 300μs, Duty Cycle ≤ 2.0%.

Typical Electrical Characteristics: N-Channel

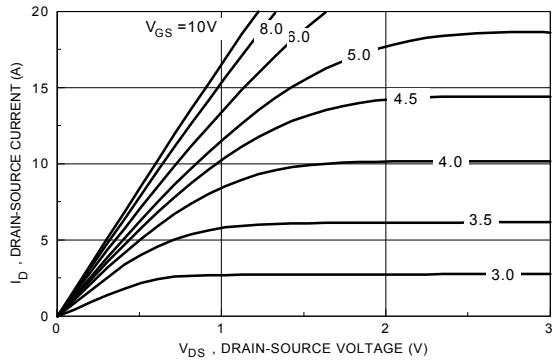

Figure 1. N-Channel On-Region Characteristics.

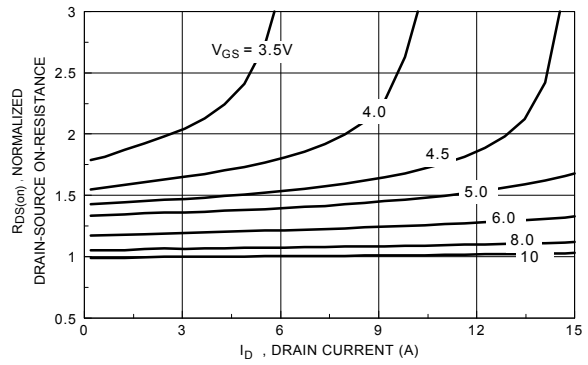

Figure 2. N-Channel On-Resistance Variation with Gate Voltage and Drain Current.

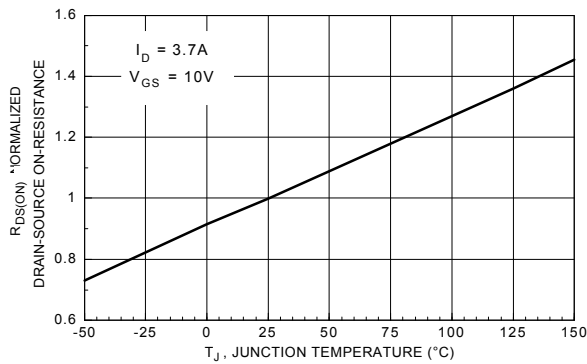

Figure 3. N-Channel On-Resistance Variation with Temperature.

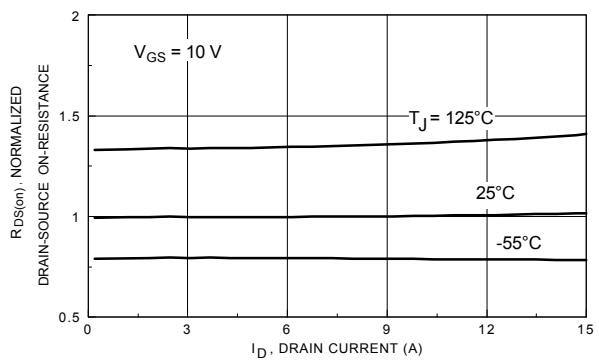

Figure 4. N-Channel On-Resistance Variation with Drain Current and Temperature.

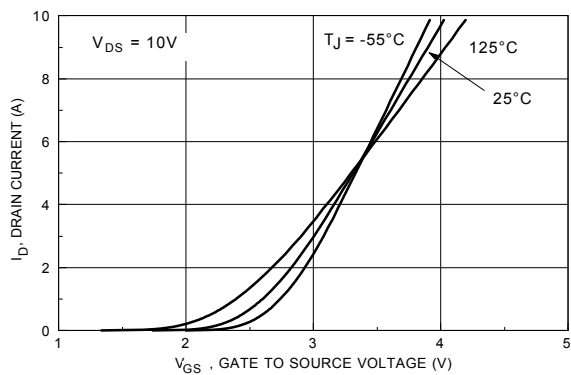

Figure 5. N-Channel Transfer Characteristics.

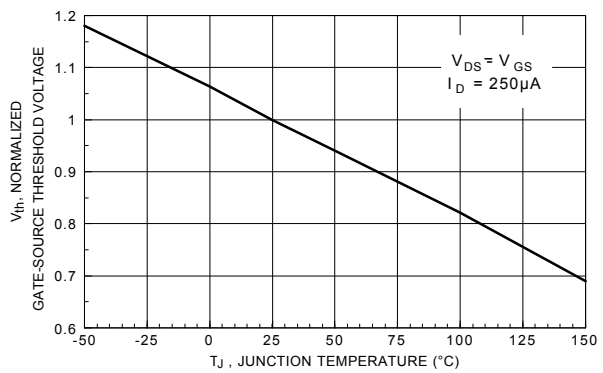

Figure 6. N-Channel Gate Threshold Variation with Temperature.

Typical Electrical Characteristics: N-Channel (continued)

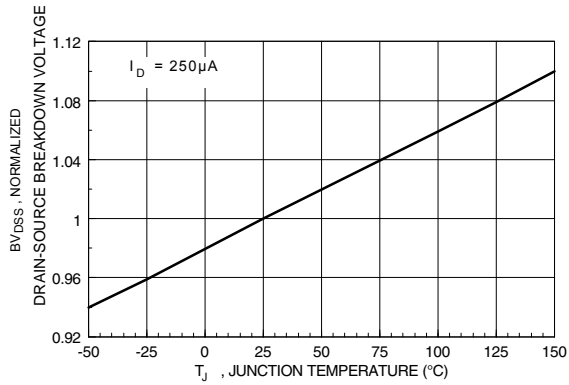

Figure 7. N-Channel Breakdown Voltage Variation with Temperature.

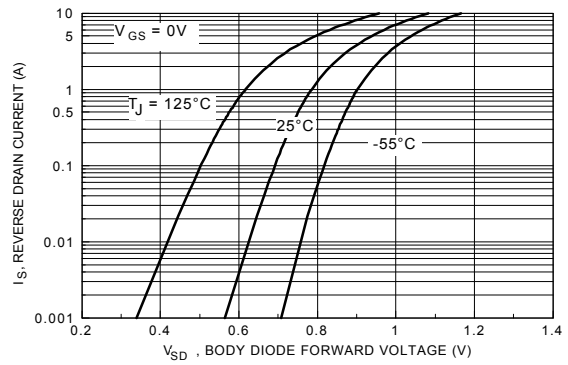

Figure 8. N-Channel Body Diode Forward Voltage Variation with Current and Temperature.

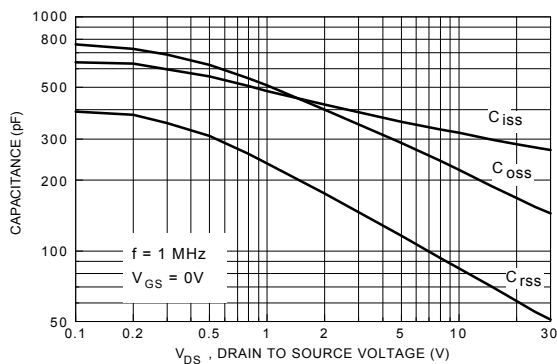

Figure 9. N-Channel Capacitance Characteristics.

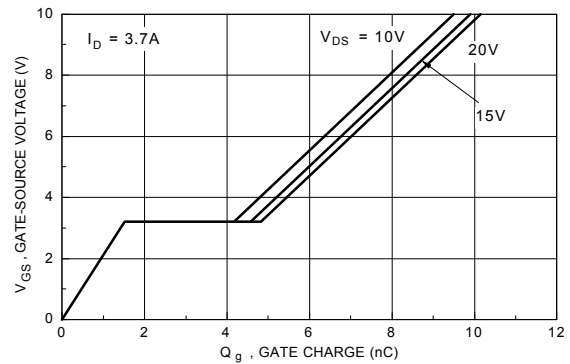

Figure 10. N-Channel Gate Charge Characteristics.

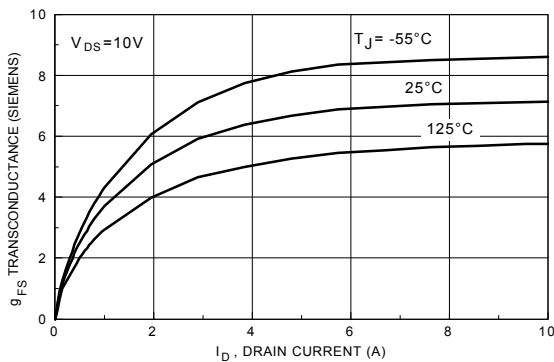

Figure 11. N-Channel Transconductance Variation with Drain Current and Temperature.

Typical Electrical Characteristics: P-Channel (continued)

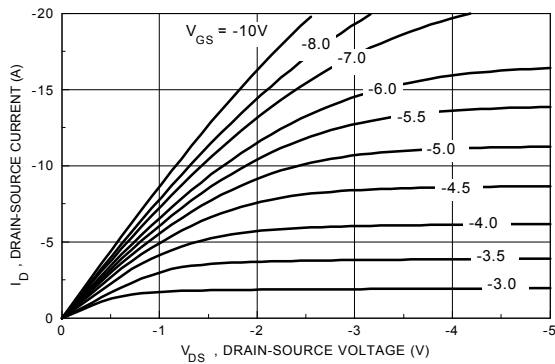

Figure 12. P-Channel On-Region Characteristics.

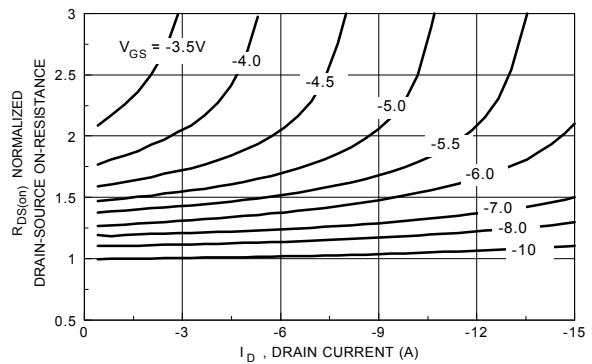

Figure 13. P-Channel On-Resistance Variation with Gate Voltage and Drain Current.

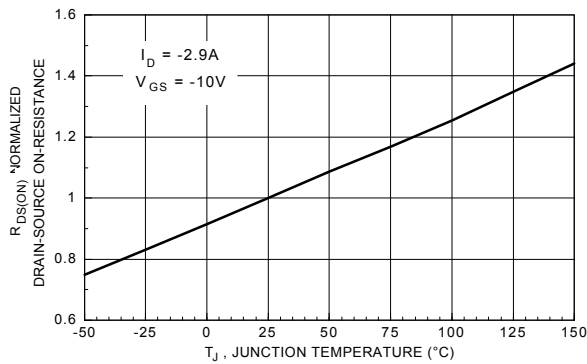

Figure 14. P-Channel On-Resistance Variation with Temperature.

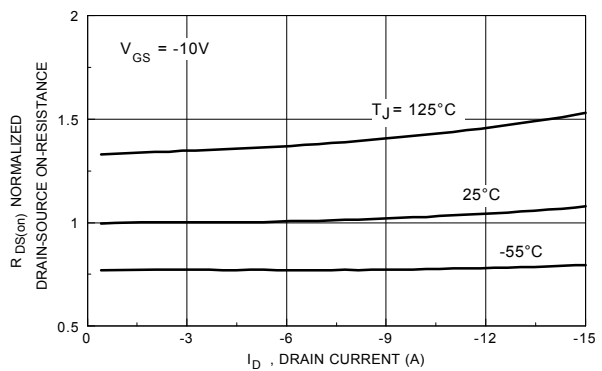

Figure 15. P-Channel On-Resistance Variation with Drain Current and Temperature.

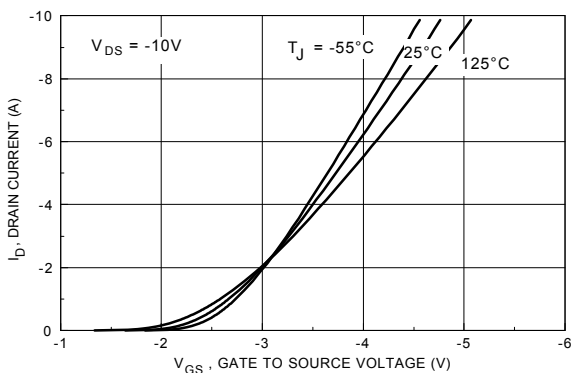

Figure 16. P-Channel Transfer Characteristics.

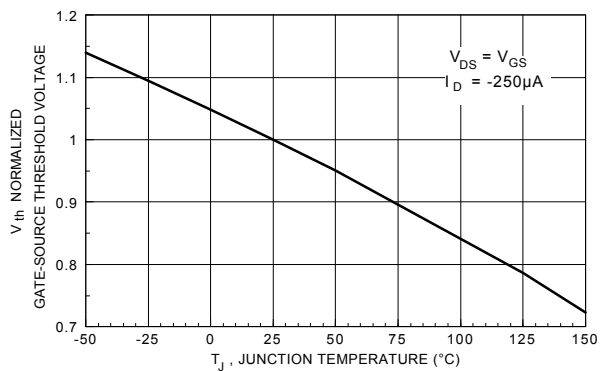

Figure 17. P-Channel Gate Threshold Variation with Temperature.

Typical Electrical Characteristics: P-Channel (continued)

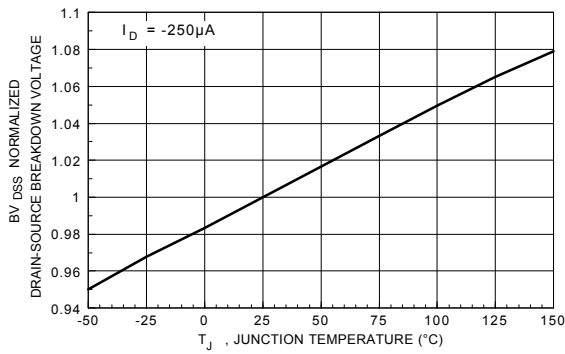

Figure 18. P-Channel Breakdown Voltage Variation with Temperature.

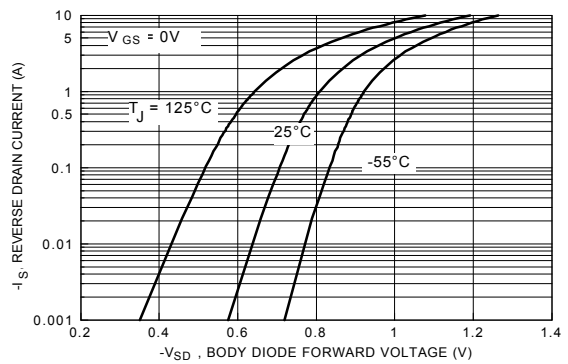

Figure 19. P-Channel Body Diode Forward Voltage Variation with Current and Temperature.

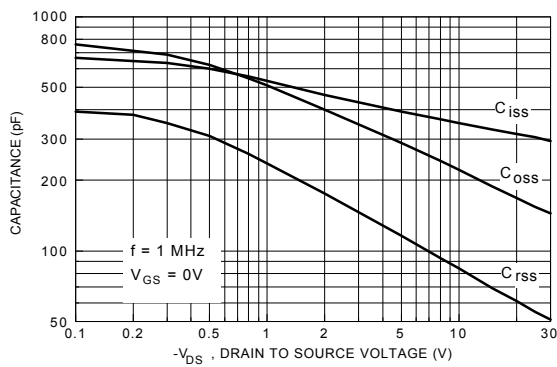

Figure 20. P-Channel Capacitance Characteristics.

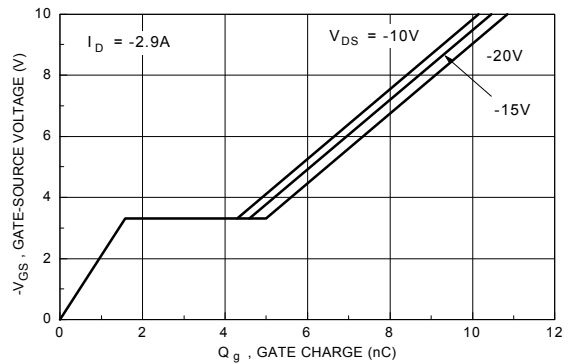

Figure 21. P-Channel Gate Charge Characteristics.

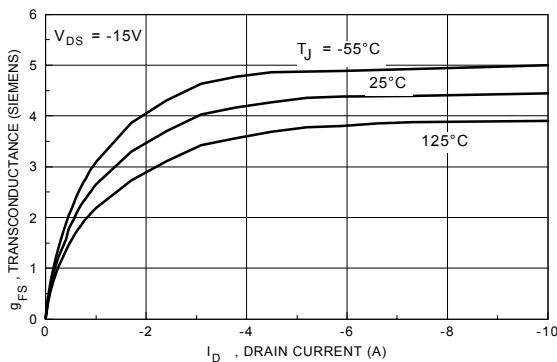

Figure 22. P-Channel Transconductance Variation with Drain Current and Temperature.

Typical Thermal Characteristics: N & P-Channel

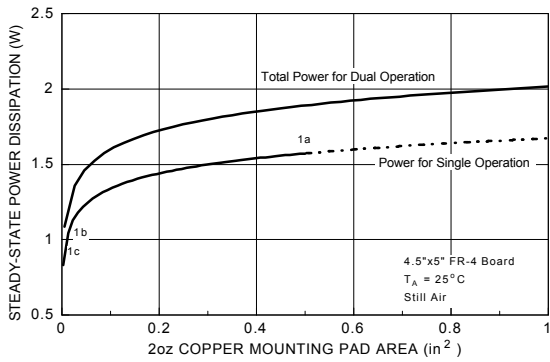

Figure 23. SO-8 Dual Package Maximum Steady-State Power Dissipation versus Copper Mounting Pad Area.

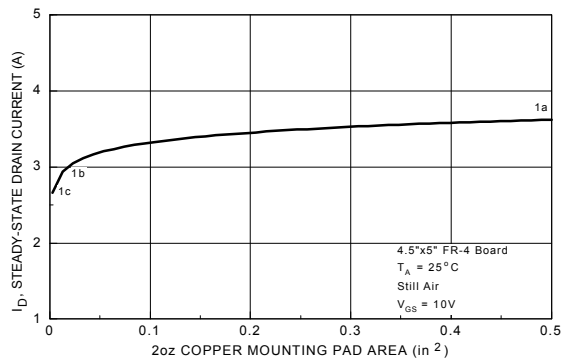

Figure 24. N-Ch Maximum Steady-State Drain Current versus Copper Mounting Pad Area.

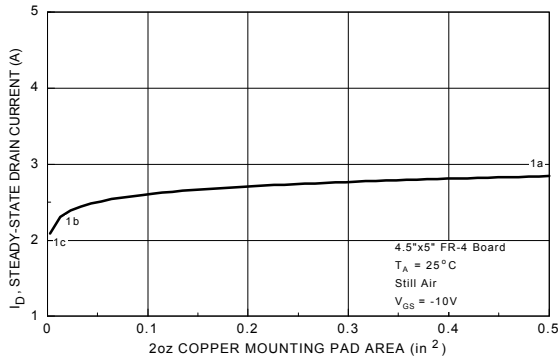

Figure 25. P-Ch Maximum Steady-State Drain Current versus Copper Mounting Pad Area.

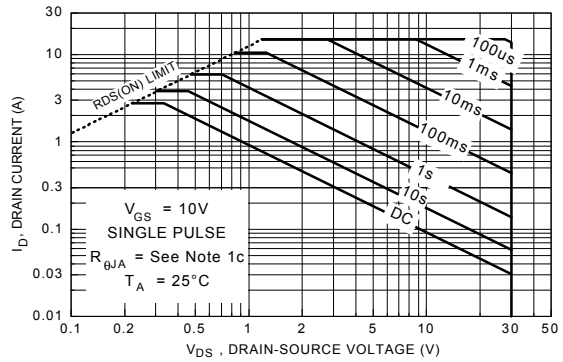

Figure 26. N-Channel Maximum Safe Operating Area.

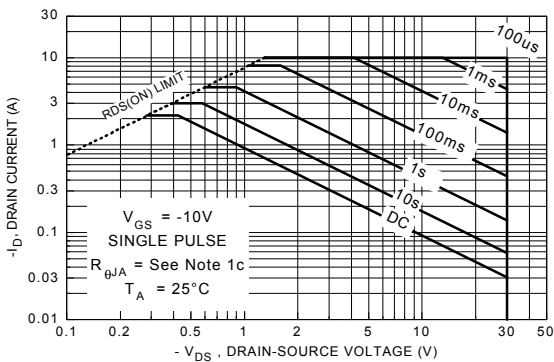

Figure 27. P-Channel Maximum Safe Operating Area.

Typical Thermal Characteristics: N & P-Channel

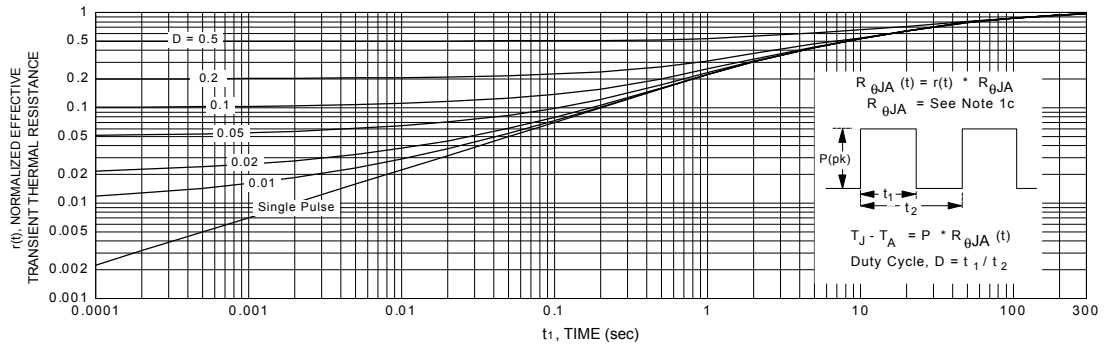

Figure 28. Transient Thermal Response Curve.

Note: Thermal characterization performed using the conditions described in note 1c. Transient thermal response will change depending on the circuit board design.

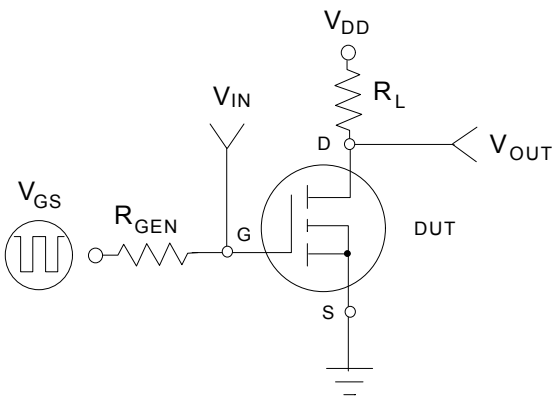

Figure 29. N or P-Channel Switching Test Circuit.

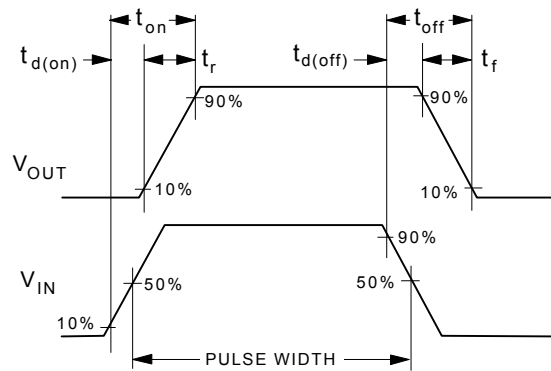

Figure 30. N or P-Channel Switching Waveforms.

TRADEMARKS

The following are registered and unregistered trademarks Fairchild Semiconductor owns or is authorized to use and is not intended to be an exhaustive list of all such trademarks.

ACEx™	HiSeC™	SuperSOT™-8
Bottomless™	ISOPLANAR™	SyncFET™
CoolFET™	MICROWIRE™	TinyLogic™
CROSSVOLT™	POP™	UHC™
E ² CMOS™	PowerTrench®	VCX™
FACT™	QFET™	
FACT Quiet Series™	QS™	
FAST®	Quiet Series™	
FASTr™	SuperSOT™-3	
GTO™	SuperSOT™-6	

DISCLAIMER

FAIRCHILD SEMICONDUCTOR RESERVES THE RIGHT TO MAKE CHANGES WITHOUT FURTHER NOTICE TO ANY PRODUCTS HEREIN TO IMPROVE RELIABILITY, FUNCTION OR DESIGN. FAIRCHILD DOES NOT ASSUME ANY LIABILITY ARISING OUT OF THE APPLICATION OR USE OF ANY PRODUCT OR CIRCUIT DESCRIBED HEREIN; NEITHER DOES IT CONVEY ANY LICENSE UNDER ITS PATENT RIGHTS, NOR THE RIGHTS OF OTHERS.

LIFE SUPPORT POLICY

FAIRCHILD'S PRODUCTS ARE NOT AUTHORIZED FOR USE AS CRITICAL COMPONENTS IN LIFE SUPPORT DEVICES OR SYSTEMS WITHOUT THE EXPRESS WRITTEN APPROVAL OF FAIRCHILD SEMICONDUCTOR CORPORATION. As used herein:

1. Life support devices or systems are devices or systems which, (a) are intended for surgical implant into the body, or (b) support or sustain life, or (c) whose failure to perform when properly used in accordance with instructions for use provided in the labeling, can be reasonably expected to result in significant injury to the user.
2. A critical component is any component of a life support device or system whose failure to perform can be reasonably expected to cause the failure of the life support device or system, or to affect its safety or effectiveness.

PRODUCT STATUS DEFINITIONS

Definition of Terms

Datasheet Identification	Product Status	Definition
Advance Information	Formative or In Design	This datasheet contains the design specifications for product development. Specifications may change in any manner without notice.
Preliminary	First Production	This datasheet contains preliminary data, and supplementary data will be published at a later date. Fairchild Semiconductor reserves the right to make changes at any time without notice in order to improve design.
No Identification Needed	Full Production	This datasheet contains final specifications. Fairchild Semiconductor reserves the right to make changes at any time without notice in order to improve design.
Obsolete	Not In Production	This datasheet contains specifications on a product that has been discontinued by Fairchild semiconductor. The datasheet is printed for reference information only.