

**QED221**

**QED222**

**QED223**

**PACKAGE DIMENSIONS**

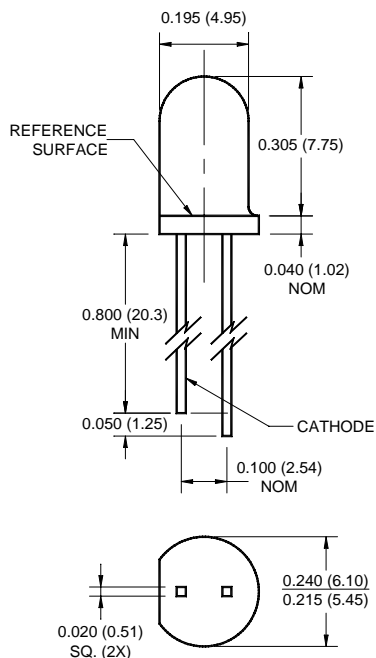

**NOTES:**

1. Dimensions for all drawings are in inches (mm).
2. Tolerance of  $\pm .010$  (.25) on all non-nominal dimensions unless otherwise specified.

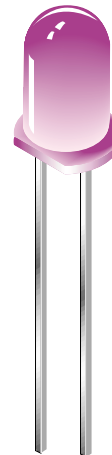

**SCHEMATIC**

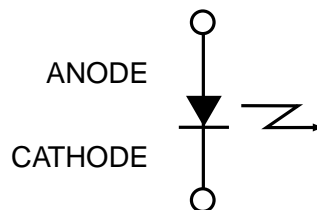

**DESCRIPTION**

The QED22X is an 880nm AlGaAs LED encapsulated in clear, purple tinted, plastic T-1 3/4 package.

**FEATURES**

- $\lambda = 880$  nm
- Chip material = AlGaAs
- Package type: T-1 3/4 (5mm lens diameter)
- Matched Photosensor: QSD122/123/124
- Medium Wide Emission Angle, 40°
- High Output Power
- Package material and color: Clear, purple tinted, plastic

**QED221**

**QED222**

**QED223**

**ABSOLUTE MAXIMUM RATINGS** ( $T_A = 25^\circ\text{C}$  unless otherwise specified)

Parameter	Symbol	Rating	Unit
Operating Temperature	$T_{OPR}$	-40 to +100	$^\circ\text{C}$
Storage Temperature	$T_{STG}$	-40 to +100	$^\circ\text{C}$
Soldering Temperature (Iron) (2,3,4)	$T_{SOL-I}$	240 for 5 sec	$^\circ\text{C}$
Soldering Temperature (Flow) (2,3)	$T_{SOL-F}$	260 for 10 sec	$^\circ\text{C}$
Continuous Forward Current	$I_F$	100	mA
Reverse Voltage	$V_R$	5	V
Power Dissipation (1)	$P_D$	200	mW
Peak Forward Current (5)	$I_{F(Peak)}$	1.5	A

**ELECTRICAL / OPTICAL CHARACTERISTICS** ( $T_A = 25^\circ\text{C}$ )

PARAMETER	TEST CONDITIONS	SYMBOL	MIN	TYP	MAX	UNITS
Peak Emission Wavelength	$I_F = 100\text{ mA}$	$\lambda_{PE}$	—	880	—	nm
Emission Angle	$I_F = 100\text{ mA}$	$\Theta$	—	$\pm 20$	—	Deg.
Forward Voltage	$I_F = 100\text{ mA}$ , $t_p = 20\text{ ms}$	$V_F$	—	—	1.7	V
Reverse Current	$V_R = 5\text{ V}$	$I_R$	—	—	10	$\mu\text{A}$
Radiant Intensity QED221	$I_F = 100\text{ mA}$ , $t_p = 20\text{ ms}$	$I_E$	10	—	20	mW/sr
Radiant Intensity QED222	$I_F = 100\text{ mA}$ , $t_p = 20\text{ ms}$	$I_E$	16	—	32	mW/sr
Radiant Intensity QED223	$I_F = 100\text{ mA}$ , $t_p = 20\text{ ms}$	$I_E$	25	—	—	mW/sr
Rise Time	$I_F = 100\text{ mA}$	$t_r$	—	800	—	ns
Fall Time		$t_f$	—	800	—	ns

1. Derate power dissipation linearly 2.67 mW/ $^\circ\text{C}$  above 25 $^\circ\text{C}$ .
2. RMA flux is recommended.
3. Methanol or isopropyl alcohols are recommended as cleaning agents.
4. Soldering iron 1/16" (1.6mm) minimum from housing.
5. Pulse conditions;  $t_p = 100\ \mu\text{s}$ ,  $T = 10\text{ ms}$ .

**QED221**

**QED222**

**QED223**

**Fig. 1 Normalized Radiant Intensity vs. Input Current**

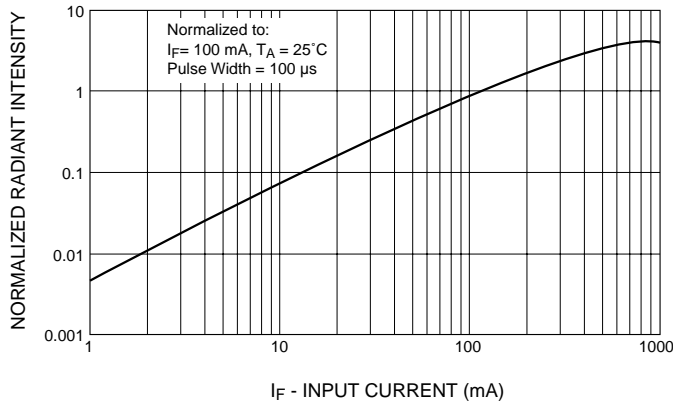

**Fig. 2 Coupling Characteristics of QED22X with QSD12X**

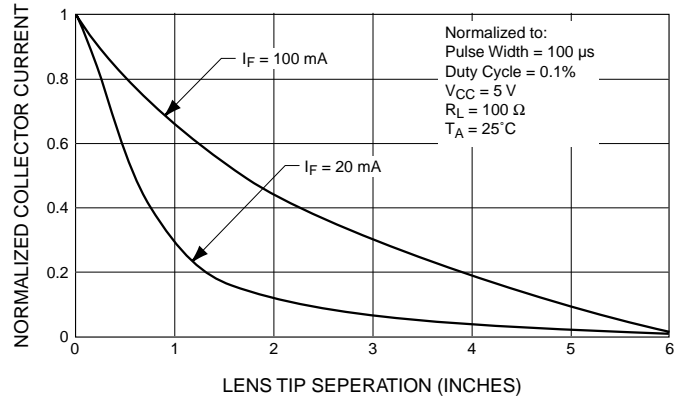

**Fig. 3 Forward Voltage vs. Temperature**

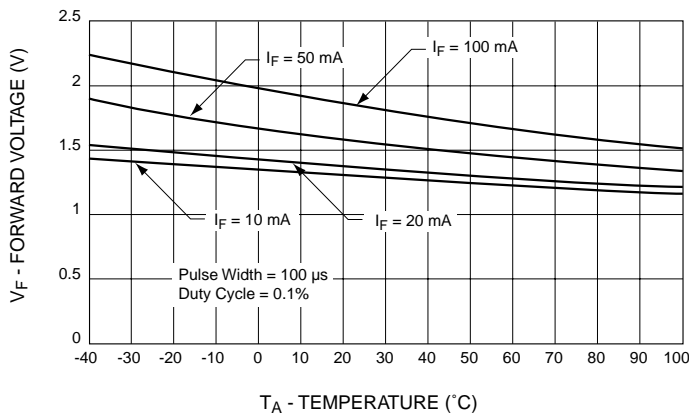

**Fig. 4 Normalized Radiant Intensity vs. Wavelength**

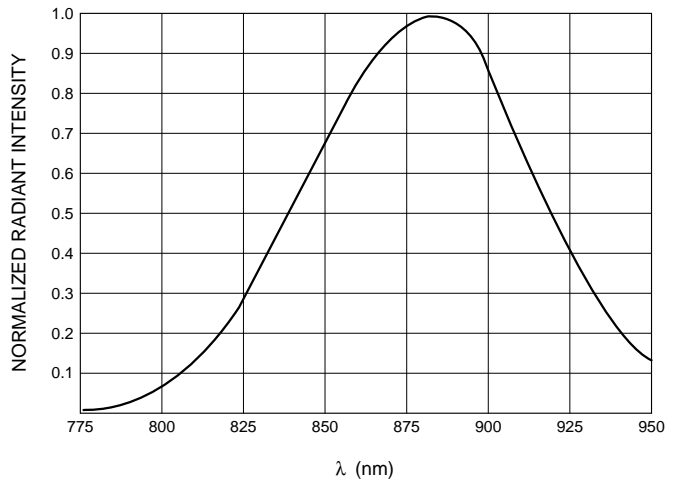

**Fig. 5 Forward Current vs. Forward Voltage**

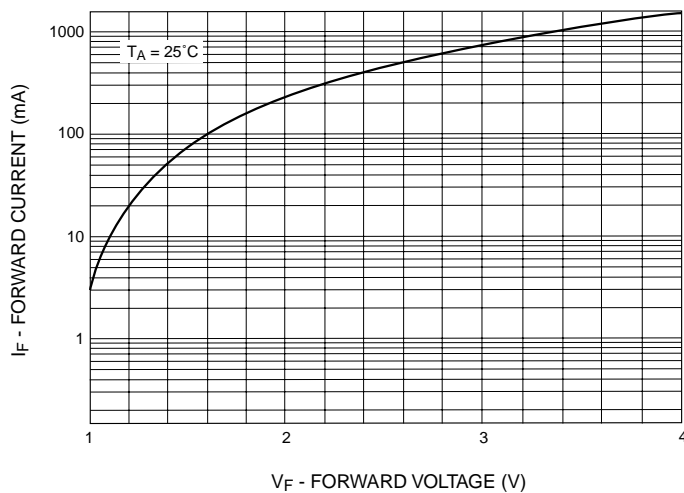

**Fig. 6 Radiation Pattern**

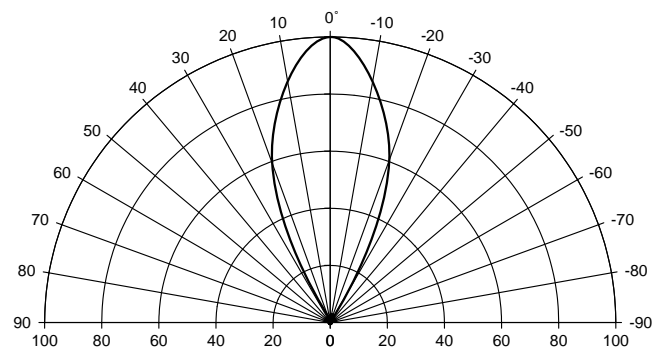

---

**QED221**

**QED222**

**QED223**

---

**DISCLAIMER**

FAIRCHILD SEMICONDUCTOR RESERVES THE RIGHT TO MAKE CHANGES WITHOUT FURTHER NOTICE TO ANY PRODUCTS HEREIN TO IMPROVE RELIABILITY, FUNCTION OR DESIGN. FAIRCHILD DOES NOT ASSUME ANY LIABILITY ARISING OUT OF THE APPLICATION OR USE OF ANY PRODUCT OR CIRCUIT DESCRIBED HEREIN; NEITHER DOES IT CONVEY ANY LICENSE UNDER ITS PATENT RIGHTS, NOR THE RIGHTS OF OTHERS.

**LIFE SUPPORT POLICY**

FAIRCHILD'S PRODUCTS ARE NOT AUTHORIZED FOR USE AS CRITICAL COMPONENTS IN LIFE SUPPORT DEVICES OR SYSTEMS WITHOUT THE EXPRESS WRITTEN APPROVAL OF THE PRESIDENT OF FAIRCHILD SEMICONDUCTOR CORPORATION. As used herein:

1. Life support devices or systems are devices or systems which, (a) are intended for surgical implant into the body, or (b) support or sustain life, and (c) whose failure to perform when properly used in accordance with instructions for use provided in labeling, can be reasonably expected to result in a significant injury of the user.
2. A critical component in any component of a life support device or system whose failure to perform can be reasonably expected to cause the failure of the life support device or system, or to affect its safety or effectiveness.