

**4A, 60V, 0.600 Ohm, Logic Level,
N-Channel Power MOSFETs**

The RFD4N06L, RFD4N06LSM are N-Channel enhancement mode silicon gate power field effect transistors specifically designed for use with logic level (5 volt) driving sources in applications such as programmable controllers, automotive switching, and solenoid drivers. This performance is accomplished through a special gate oxide design which provides full rated conduction at gate biases in the 3-5 volt range, thereby facilitating true on-off power control from logic circuit supply voltages.

Formerly developmental type TA09520.

Ordering Information

PART NUMBER	PACKAGE	BRAND
RFD4N06L	TO-251AA	RFD4N06L
RFD4N06LSM	TO-252AA	RFD4N06LSM

NOTE: When ordering, use the entire part number.

Features

- 4A, 60V
- $r_{DS(ON)} = 0.600\Omega$
- Design Optimized for 5 Volt Gate Drive
- Can be Driven Directly From Q-MOS, N-MOS, or TTL Circuits
- SOA is Power Dissipation Limited
- 175°C Rated Junction Temperature
- Logic Level Gate
- High Input Impedance
- Related Literature
 - TB334 "Guidelines for Soldering Surface Mount Components to PC Boards"

Symbol

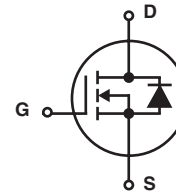

Packaging

JEDEC TO-251AA

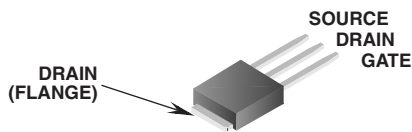

JEDEC TO-252AA

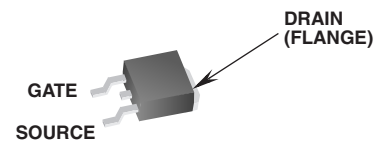

RFD4N06L, RFD4N06LSM

Absolute Maximum Ratings $T_C = 25^\circ\text{C}$, Unless Otherwise Specified

	RFD4N06L	RFD4N06LSM	UNITS
Drain to Source Breakdown Voltage (Note 1)	60	60	V
Drain to Gate Voltage (Note 1)	60	60	V
Gate to Source Voltage	± 10	± 10	V
Continuous Drain Current	4	4	A
Pulsed Drain Current (Note 3)	10	10	A
Maximum Power Dissipation	30	30	W
Derated above 25°C .	0.20	0.20	W/ $^\circ\text{C}$
Operating and Storage Temperature	-55 to 175	-55 to 175	$^\circ\text{C}$
Maximum Temperature for Soldering			
Leads at 0.063in (1.6mm) from Case for 10s.	300	300	$^\circ\text{C}$
Package Body for 10s, See Techbrief 334	260	260	$^\circ\text{C}$

CAUTION: Stresses above those listed in "Absolute Maximum Ratings" may cause permanent damage to the device. This is a stress only rating and operation of the device at these or any other conditions above those indicated in the operational sections of this specification is not implied.

NOTE:

1. $T_J = 25^\circ\text{C}$ to 150°C .

Electrical Specifications $T_C = 25^\circ\text{C}$, Unless Otherwise Specified

PARAMETER	SYMBOL	TEST CONDITIONS	MIN	TYP	MAX	UNITS
Drain to Source Breakdown Voltage	BV_{DSS}	$I_D = 1\text{mA}$, $V_{GS} = 0\text{V}$	60	-	-	V
Gate to Threshold Voltage	$V_{GS(TH)}$	$V_{GS} = V_{DS}$, $I_D = 250\mu\text{A}$	1	-	2.5	V
Zero Gate Voltage Drain Current	I_{DSS}	$T_C = 25^\circ\text{C}$, $V_{DS} = 50\text{V}$, $V_{GS} = 0\text{V}$	-	-	1	μA
		$T_C = 125^\circ\text{C}$, $V_{DS} = 50\text{V}$, $V_{GS} = 0\text{V}$	-	-	50	μA
Gate to Source Leakage Current	I_{GSS}	$V_{GS} = \pm 10\text{V}$, $V_{DS} = 0\text{V}$	-	-	± 100	nA
Drain to Source On Voltage (Note 2)	$V_{DS(ON)}$	$I_D = 1\text{A}$, $V_{GS} = 5\text{V}$	-	-	0.8	V
		$I_D = 2\text{A}$, $V_{GS} = 5\text{V}$	-	-	2.0	V
		$I_D = 4\text{A}$, $V_{GS} = 7.5\text{V}$	-	-	4.0	V
Drain to Source On Resistance (Note 2)	$r_{DS(ON)}$	$I_D = 1\text{A}$, $V_{GS} = 5\text{V}$	-	-	0.600	Ω
Forward Transconductance (Note 2)	$V_{(plateau)}$	$V_{DS} = 15\text{V}$, $I_D = 4\text{A}$	-	-	4.5	V
Turn-On Delay Time	$t_{d(ON)}$	$V_{DD} = 30\text{V}$, $I_D = 1\text{A}$, $R_{GS} = 6.25\Omega$, $V_{GS} = 5\text{V}$	-	-	20	ns
Rise Time	t_r		-	-	130	ns
Turn-Off Delay Time	$t_{d(OFF)}$		-	-	40	ns
Fall Time	t_f		-	-	160	ns
Total Gate Charge (Gate to Source + Gate to Drain)	$Q_g(TOT)$	$V_{GS} = 0-10\text{V}$	-	-	8	nC
Gate Charge at 5V	$Q_g(5)$	$V_{GS} = 0-5\text{V}$				
Threshold Gate Charge	$Q_g(TH)$	$V_{GS} = 0-1\text{V}$				
Thermal Resistance Junction to Case	$R_{\theta JC}$		-	-	5	$^\circ\text{C}/\text{W}$

Source to Drain Diode Specifications

PARAMETER	SYMBOL	TEST CONDITIONS	MIN	TYP	MAX	UNITS
Source to Drain Diode Voltage (Note 2)	V_{SD}	$I_{SD} = 1\text{A}$	-	-	1.4	V
Reverse Recovery Time	t_{rr}	$I_{SD} = 2\text{A}$, $dI_{SD}/dt = 100\text{A}/\mu\text{s}$	-	150	-	ns

NOTES:

2. Pulsed: pulse duration = $300\mu\text{s}$ max, duty cycle = 2%.
3. Repetitive rating: pulse width limited by maximum junction temperature.

Typical Performance Curves Unless Otherwise Specified

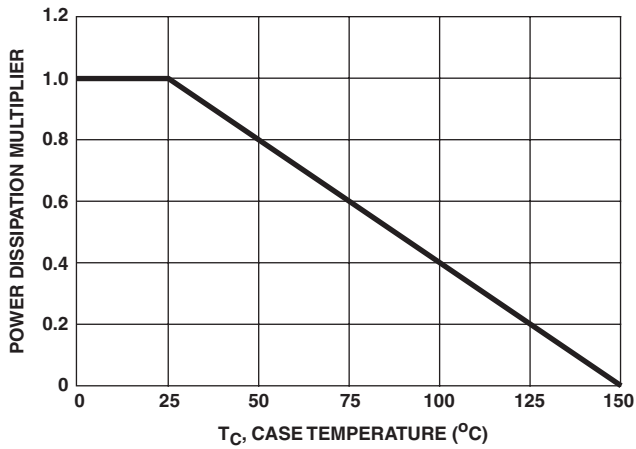

FIGURE 1. NORMALIZED POWER DISSIPATION vs CASE TEMPERATURE

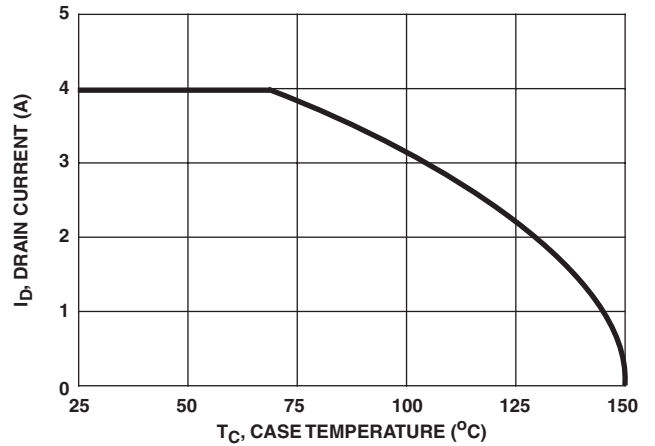

FIGURE 2. MAXIMUM CONTINUOUS DRAIN CURRENT vs CASE TEMPERATURE

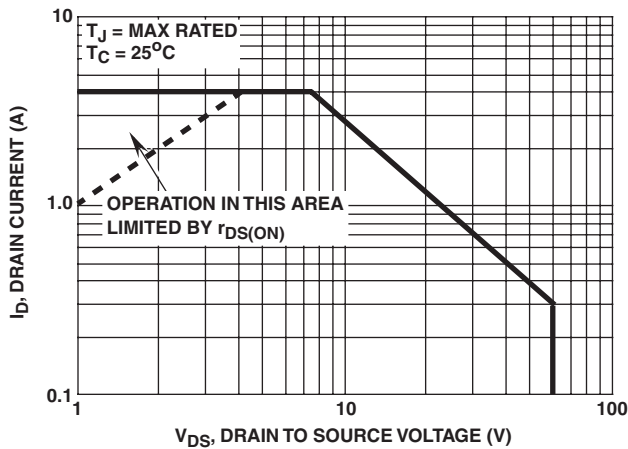

FIGURE 3. FORWARD BIAS SAFE OPERATING AREA

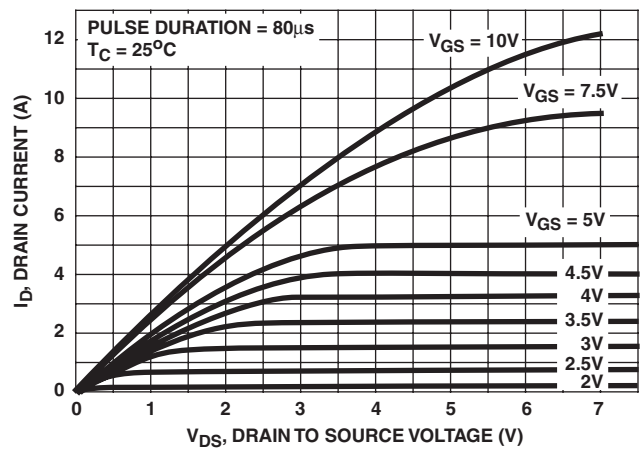

FIGURE 4. SATURATION CHARACTERISTICS

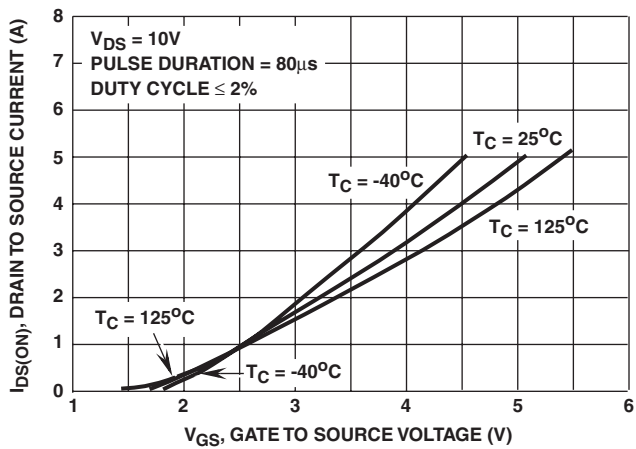

FIGURE 5. TRANSFER CHARACTERISTICS

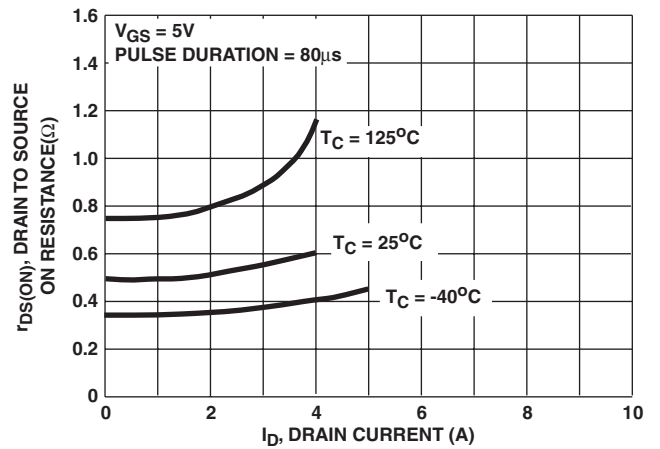

FIGURE 6. DRAIN TO SOURCE ON RESISTANCE vs DRAIN CURRENT

Typical Performance Curves Unless Otherwise Specified (Continued)

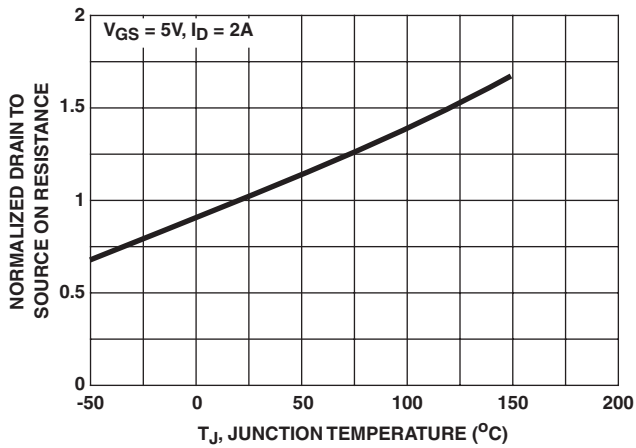

FIGURE 7. NORMALIZED DRAIN TO SOURCE ON RESISTANCE vs JUNCTION TEMPERATURE

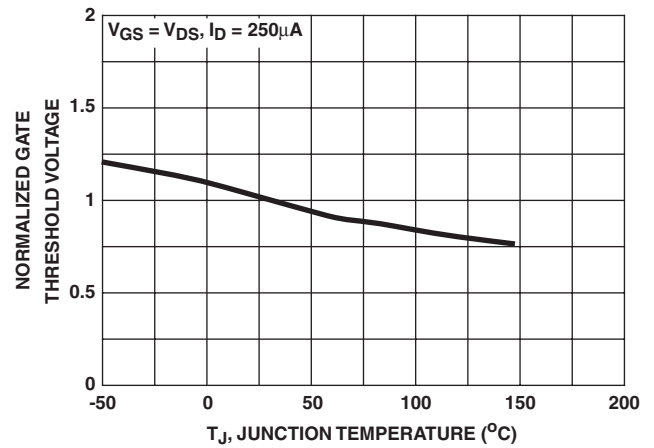

FIGURE 8. NORMALIZED GATE THRESHOLD VOLTAGE vs JUNCTION TEMPERATURE

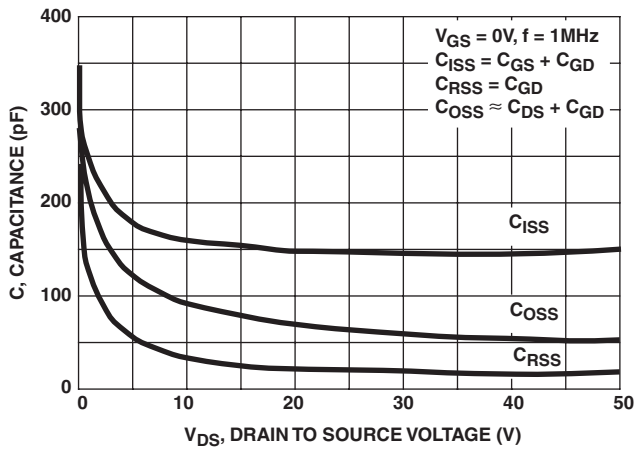
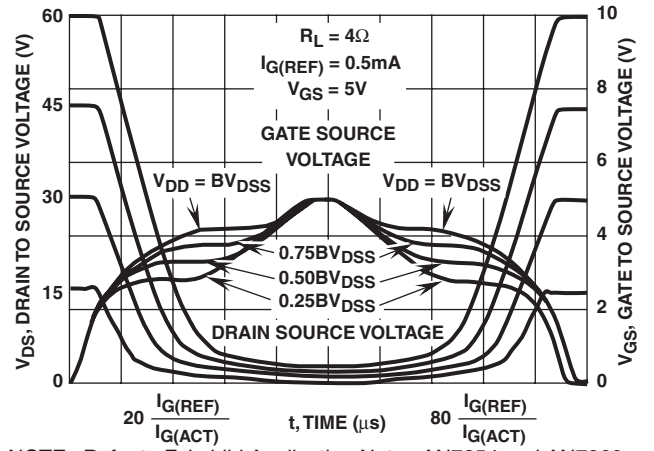

FIGURE 9. CAPACITANCE vs DRAIN TO SOURCE VOLTAGE



NOTE: Refer to Fairchild Application Notes AN7254 and AN7260.

FIGURE 10. NORMALIZED SWITCHING WAVEFORMS FOR CONSTANT GATE CURRENT

Test Circuits and Waveforms

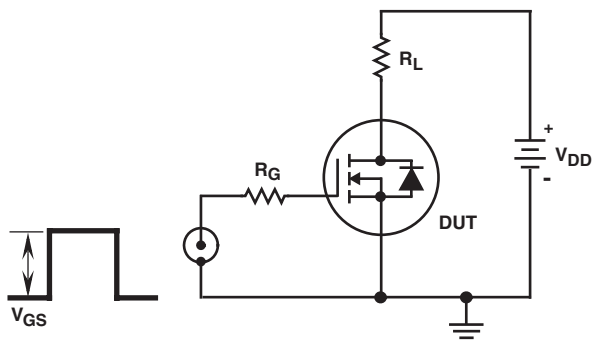

FIGURE 11. SWITCHING TIME TEST CIRCUIT

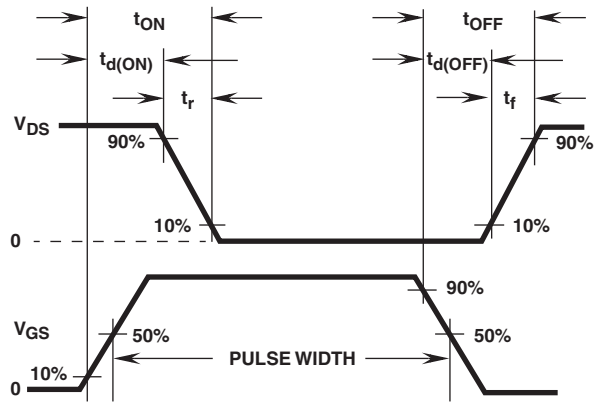

FIGURE 12. RESISTIVE SWITCHING WAVEFORMS

TRADEMARKS

The following are registered and unregistered trademarks Fairchild Semiconductor owns or is authorized to use and is not intended to be an exhaustive list of all such trademarks.

ACE _x TM	FAST [®]	OPTOLOGIC TM	SMART START TM	VCX TM
Bottomless TM	FAST _r TM	OPTOPLANAR TM	STAR*POWER TM	
CoolFET TM	FRFET TM	PACMAN TM	Stealth TM	
CROSSVOLT TM	GlobalOptoisolator TM	POP TM	SuperSOT TM -3	
DenseTrench TM	GTO TM	Power247 TM	SuperSOT TM -6	
DOMET TM	HiSeC TM	PowerTrench [®]	SuperSOT TM -8	
EcoSPARK TM	ISOPLANAR TM	QFET TM	SyncFET TM	
E ² CMOS TM	LittleFET TM	QST TM	TinyLogic TM	
EnSigna TM	MicroFET TM	QT Optoelectronics TM	TruTranslation TM	
FACT TM	MicroPak TM	Quiet Series TM	UHC TM	
FACT Quiet Series TM	MICROWIRE TM	SILENT SWITCHER [®]	UltraFET [®]	

STAR*POWER is used under license

DISCLAIMER

FAIRCHILD SEMICONDUCTOR RESERVES THE RIGHT TO MAKE CHANGES WITHOUT FURTHER NOTICE TO ANY PRODUCTS HEREIN TO IMPROVE RELIABILITY, FUNCTION OR DESIGN. FAIRCHILD DOES NOT ASSUME ANY LIABILITY ARISING OUT OF THE APPLICATION OR USE OF ANY PRODUCT OR CIRCUIT DESCRIBED HEREIN; NEITHER DOES IT CONVEY ANY LICENSE UNDER ITS PATENT RIGHTS, NOR THE RIGHTS OF OTHERS.

LIFE SUPPORT POLICY

FAIRCHILD'S PRODUCTS ARE NOT AUTHORIZED FOR USE AS CRITICAL COMPONENTS IN LIFE SUPPORT DEVICES OR SYSTEMS WITHOUT THE EXPRESS WRITTEN APPROVAL OF FAIRCHILD SEMICONDUCTOR CORPORATION.

As used herein:

1. Life support devices or systems are devices or systems which, (a) are intended for surgical implant into the body, or (b) support or sustain life, or (c) whose failure to perform when properly used in accordance with instructions for use provided in the labeling, can be reasonably expected to result in significant injury to the user.
2. A critical component is any component of a life support device or system whose failure to perform can be reasonably expected to cause the failure of the life support device or system, or to affect its safety or effectiveness.

PRODUCT STATUS DEFINITIONS

Definition of Terms

Datasheet Identification	Product Status	Definition
Advance Information	Formative or In Design	This datasheet contains the design specifications for product development. Specifications may change in any manner without notice.
Preliminary	First Production	This datasheet contains preliminary data, and supplementary data will be published at a later date. Fairchild Semiconductor reserves the right to make changes at any time without notice in order to improve design.
No Identification Needed	Full Production	This datasheet contains final specifications. Fairchild Semiconductor reserves the right to make changes at any time without notice in order to improve design.
Obsolete	Not In Production	This datasheet contains specifications on a product that has been discontinued by Fairchild semiconductor. The datasheet is printed for reference information only.