

1.5A SmartOR™ Dual Regulator with V_{AUX} Drive

Features

- Selects from 3 input voltages and provides 3.3V output
- Automatic selection of V_{CC} , V_{SBY} or V_{AUX}
- Drive control signal for external V_{AUX} switch
- Glitch-free 3.3V output during supply transitions
- Built-in hysteresis for supply selection
- V_{CC} regulates up to 1.5A output current
- V_{SBY} regulates up to 375mA output current
- Foldback current limiting
- Thermal shutdown with hysteresis
- TO-263 standard and thin-body packages
- Lead-free versions available

Applications

- Peripheral Component Interface (PCI) Adapter Cards
- Network Interface Cards (NICs)
- Multiple Powered Systems
- Systems with Standby Capabilities

Product Description

The California Micro Devices' SmartOR™ CMPWR280 is a fully protected Dual-Input low-dropout CMOS regulator that also provides the necessary control signal for driving an external auxiliary P-channel MOSFET switch. The SmartOR™ device automatically selects one of three possible inputs on a priority basis: V_{CC} (1.5A), V_{SBY} (375mA) or V_{AUX} via the drive signal used to control an external switch.

V_{CC} is given first priority. In the event of the V_{CC} supply being powered down, the device will automatically deselect the V_{CC} prior to regulator dropout and immediately select V_{SBY} (second priority) as its power source.

If neither V_{CC} nor V_{SBY} are present the drive control output will turn-on an external P-channel MOSFET switch from an auxiliary 3.3V supply V_{AUX} to V_{OUT} .

All the necessary control circuitry needed to provide a smooth and automatic transition between all three supplies has been incorporated. This allows V_{CC} to be dynamically switched without loss of output voltage.

The CMPWR280 is internally protected against output short-circuits, current overload and thermal overload.

The CMPWR280 is housed in both a standard, 5-lead TO-263 package or a thin-body, 5-lead TO-263 package and is available with optional lead-free finishing.

Typical Application Circuit

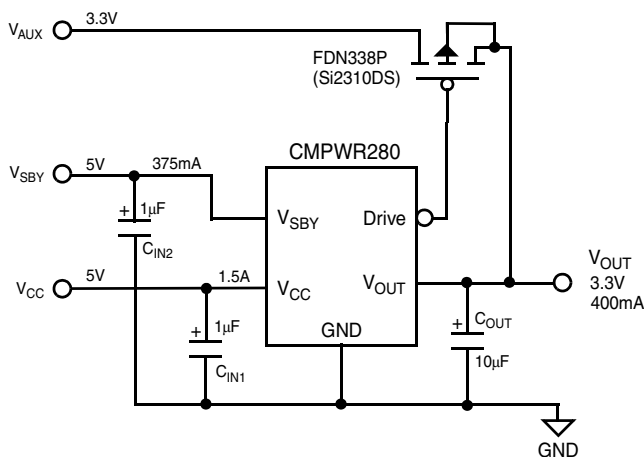

Simplified Electrical Schematic

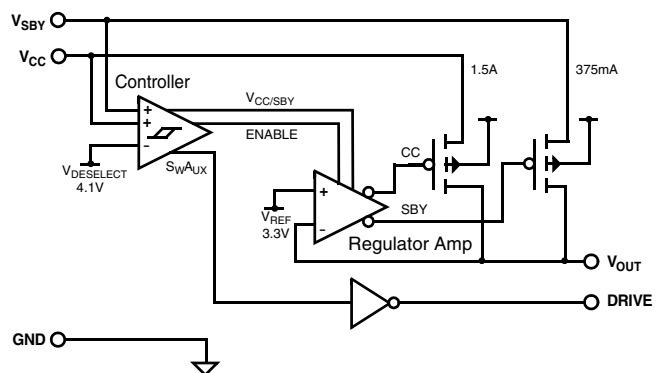

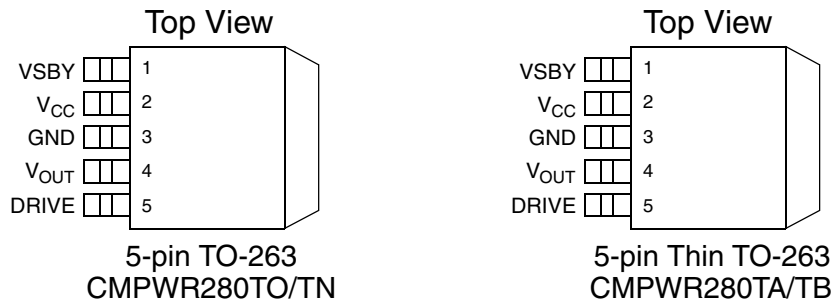
PACKAGE / PINOUT DIAGRAM

Note: These drawings are not to scale.

PIN DESCRIPTIONS

PIN(S)	NAME	DESCRIPTION
1	V_{SBY}	V_{SBY} is the standby 5V supply power source, which is only selected on when $V_{CC} < V_{CCDES}$. If V_{SBY} is selected, the regulator can deliver a maximum of 375mA load current. Whenever V_{SBY} exceeds both V_{CC} and V_{OUT} , it will be used to provide all the internal bias currents and any necessary regulator current.
2	V_{CC}	<p>V_{CC} is the primary 5V power supply for the internal regulator. Whenever V_{CC} exceeds V_{CCSEL} (4.5V), the internal regulator (up to 1500mA) will be enabled and deliver a fixed 3.3V at V_{OUT}. When V_{CC} falls below V_{CCDES} (4.1V typically) the regulator will be disabled.</p> <p>Internal loading on this pin is typically 1.5mA when the regulator is enabled, which reduces to 0.2mA whenever the regulator is disabled. If V_{CC} falls below either the V_{SBY} or V_{OUT} voltage, the loading on V_{CC} will reduce to only a few microamperes.</p> <p>During a V_{CC} power up sequence, there will be an effective step increase in V_{CC} line current when the regulator is enabled. The amplitude of this step increase will depend on the dc load current and any current required for charging/discharging the load capacitance. This line current transient will cause a voltage disturbance at the V_{CC} pin proportional to the effective power supply source impedance being delivered to the V_{CC} input.</p> <p>To prevent chatter during Select and Deselect transitions, a built-in hysteresis voltage of 400mV has been incorporated. It is recommended that the power supply connected to the V_{CC} input should have a source impedance of less than 0.15Ω to minimize the chatter during the enabling/disabling of the regulator.</p>
3	GND	GND is the negative reference for all voltages. The current that flows in the ground connection is very low (typically 2.0mA) and has minimal variation over all load conditions.
4	V_{OUT}	<p>V_{OUT} is the regulator output voltage connection used to power the load. An output capacitor of ten microfarads is used to provide the necessary phase compensation, thereby preventing oscillation. The capacitor also helps to minimize the peak output disturbance during power supply changeover.</p> <p>When both V_{CC} and V_{SBY} falls below V_{OUT}, then V_{OUT} will be used to provide the necessary quiescent current for the internal reference circuits. This ensures excellent start-up characteristics for the regulator.</p>
5	DRIVE	<p>Drive is an active LOW logic output intended to be used as the control signal for driving an external P-channel MOSFET switch whenever the regulator is disabled. This will allow the voltage at V_{OUT} to be powered from an auxiliary supply voltage (3.3V).</p> <p>The Drive pin is pulled HIGH to V_{CC} whenever the regulator is enabled, thus ensuring that the auxiliary supply remains isolated during normal regulator operation.</p>

Ordering Information

PART NUMBERING INFORMATION						
Regulator	Pins	Package	Standard Finish		Lead-free Finish	
			Ordering Part Number ¹	Part Marking	Ordering Part Number ¹	Part Marking
CMPWR280	5	TO-263	CMPWR280TO	CMPWR280TO	CMPWR280TN	CMPWR280TN
CMPWR280	5	Thin TO-263	CMPWR280TA	CMPWR280TA	CMPWR280TB	CMPWR280TB

Note 1: Parts are shipped in Tape & Reel form unless otherwise specified.

Specifications

ABSOLUTE MAXIMUM RATINGS		
PARAMETER	RATING	UNITS
ESD Protection (HBM)	±2000	V
Pin Voltages V _{CC} , V _{SBY} , V _{OUT} , DRIVE	[GND - 0.5] to [+6.0] [GND - 0.5] to [V _{CC} (V _{SBY})+ 0.5]	V V
Storage Temperature Range	-40 to +150	°C
Operating Temperature Range Ambient Junction	0 to +70 0 to +150	°C °C
Power Dissipation (See Note 1) TO-263 Thin TO-263	Internally Limited Internally Limited	W W

Note 1: The maximum power dissipation of this device is internally limited by thermal shutdown circuitry. To achieve a power dissipation of 3.0 watts, a case-to-ambient thermal resistance of 25°C/W must be provided. This will typically require dedicated heatsinking ability of the printed circuit board. For more details, please see the Typical Thermal Characteristics section.

STANDARD OPERATING CONDITIONS		
PARAMETER	RATING	UNITS
V _{CC} , V _{SBY} Input Voltage	4.75 to 5.25	V
Ambient Operating Temperature Range	0 to +70	°C
C _{EXT}	10 ±10%	µF

Specifications (cont'd)

ELECTRICAL OPERATING CHARACTERISTICS (NOTE 1)						
SYMBOL	PARAMETER	CONDITIONS	MIN	TYP	MAX	UNITS
V_{OUT}	Regulator Output Voltage	$0mA < I_{LOAD} < 1500mA (V_{CC})$ $0mA < I_{LOAD} < 375mA (V_{SBY})$	3.135	3.300	3.465	V
V_{CCSEL}	Select Voltage	V_{CC} Regulator Enabled		4.50	4.70	V
V_{CCDES}	V_{CC} Deselect Voltage	V_{CC} Regulator Disabled	3.90	4.10		V
V_{CCHYST}	Hysteresis Voltage	V_{CC} Hysteresis, See Note 2		0.40		V
I_{OUT}	Regulator Output Current	V_{CC} Selected V_{SBY} Selected	1500 375	2500 750		mA mA
I_{SC}	Short-circuit Output Current	V_{CC} Selected V_{SBY} Selected		800 200		mA mA
I_{RCC}	V_{CC} Pin Reverse Leakage	$V_{SBY}=5.0V; V_{CC} = 0V$		10	100	μA
I_{RSBY}	V_{SBY} Pin Reverse Leakage	$V_{SBY}=0V; V_{CC} = 5.0V$		10	100	μA
$V_{R\ LOAD}$	V_{CC} Load Regulation	V_{CC} selected, $I_{LOAD}=15mA$ to $1500mA$		30		mV
	V_{SBY} Load Regulation	V_{SBY} selected, $I_{LOAD}=5mA$ to $375mA$		30		mV
$V_{R\ LINE}$	Line Regulation	$V_{CC}=4.5$ to $5.5V, I_{LOAD}=5mA$		5		mV
I_{CC}	V_{CC} Supply Current	V_{CC} selected, $I_{OUT}=0mA$ $V_{CCDES} > V_{CC} > V_{AUX}$ or V_{OUT}		1.5	3.0	mA
				0.1	0.2	mA
I_{SBY}	V_{SBY} Supply Current	V_{SBY} selected, $I_{OUT}=0mA$		1.5	3.0	mA
I_{GND}	Ground Pin Current (Note 3)	Regulator disabled (only V_{OUT} present)		0.2	0.3	mA
		Regulator selected, $I_{LOAD}=5mA$		1.5	3.0	mA
		Regulator selected = $5V, I_{LOAD}=500mA$		1.8	3.5	mA
R_{OH} R_{OL}	Drive R_{DS} High	R_{DS} to $V_{CC}, V_{CC} > V_{CCSEL}$		5	10	$k\Omega$
	Drive R_{DS} Low	R_{DS} to $GND, V_{CCDES} > V_{CC}$		0.5	1	$k\Omega$
t_{DH} t_{DL}	Drive High Delay	$C_{DRIVE}=1nF, V_{CC} t_{RISE} < 100ns$		5.0		μs
	Drive Low Delay	$C_{DRIVE}=1nF, V_{CC} t_{FALL} < 100ns$		0.5		μs
$T_{DISABLE}$	Shutdown Temperature			165		$^{\circ}C$
T_{HYST}	Thermal Hysteresis			30		$^{\circ}C$

Note 1: Operating Characteristics are over Standard Operating Conditions unless otherwise specified.

Note 2: The hysteresis defines the maximum level of acceptable disturbance on V_{CC} during switching. It is recommended that the V_{CC} source impedance be kept below 0.15Ω to ensure the switching disturbance remains below the hysteresis during select/deselect transitions.

Note 3: Ground pin current consists of controller current ($0.2mA$) and regulator current when selected.

Typical DC Characteristics

Unless stated otherwise, all DC characteristics were measured at room temperature with a nominal V_{CC} supply voltage of 5.0 volts and an output capacitance of 10 μ F.

V_{CC} Line Regulation, as shown in Figure 1, is measured while forcing the deselect threshold to an artificial low level for loads of 100mA, 500mA and 1.5A. At the maximum rated load of 1.5A, a drop in line regulation occurs when the V_{CC} supply voltage drops below 3.8V. For light load conditions (100mA), regulation is maintained as low as 3.2V.

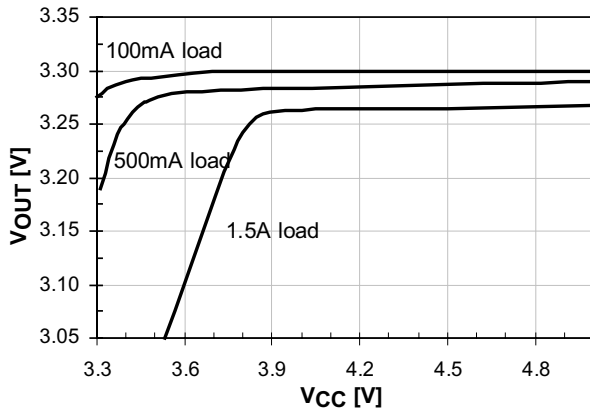

Figure 1. V_{CC} Line Regulation

V_{CC} Load Regulation (pulse condition) performance is shown up to and beyond the rated load. A change in load from 10% to 100% of rated current (150mA to 1500mA) results in an output voltage change of about 20mV. This translates into an effective output impedance of less than 15M Ω .

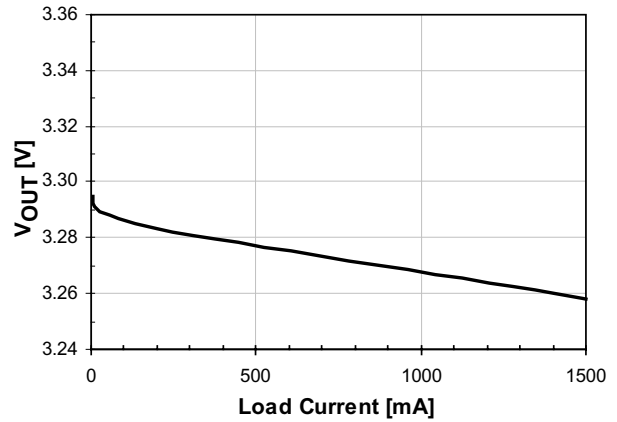

Figure 2. V_{CC} Load Regulation

V_{SBY} Load Regulation (pulse condition) performance is shown up to and beyond the rated load. A change in load from 10% to 100% of rated (50mA to 500mA) results in an output voltage change of about 20mV. This translates into an effective output impedance of less than 50M Ω .

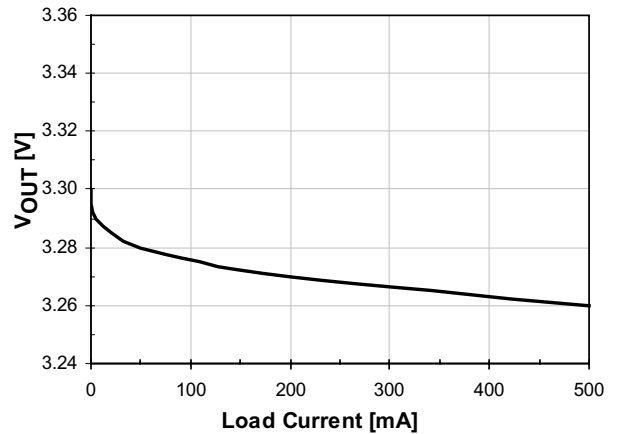

Figure 3. V_{SBY} Load Regulation

Typical DC Characteristics (cont'd)

Ground Current is shown across the entire range of load conditions in [Figure 4](#). The ground current of 2mA has minimal variation across the range of load conditions and shows only a slight increase at maximum load. This slight increase at rated load is due to the current limit protection circuitry becoming active.

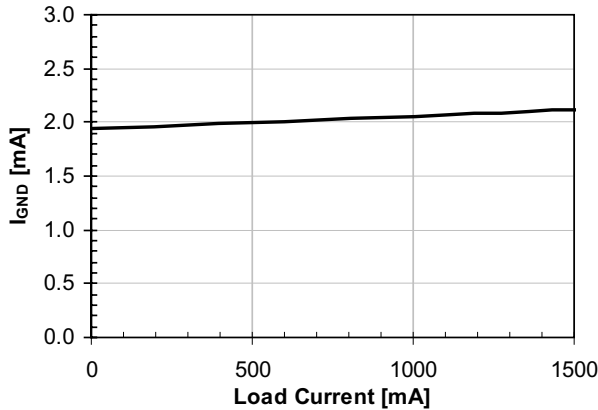

Figure 4. Ground Current

V_{CC} Supply Current of the device is shown across the entire V_{CC} range in [Figure 5](#).

In the absence of V_{AUX}, the supply current remains fixed at approximately 0.15mA until V_{CC} reaches the Select voltage threshold of 4.35V. At this point the regulator is enabled and a supply current of 1.0mA is conducted.

When V_{AUX} is present, the V_{CC} supply current is less than 10µA until V_{CC} exceeds V_{AUX}, at which point V_{CC} then powers the controller (0.15mA). When V_{CC} reaches V_{SELECT}, the regulator is enabled.

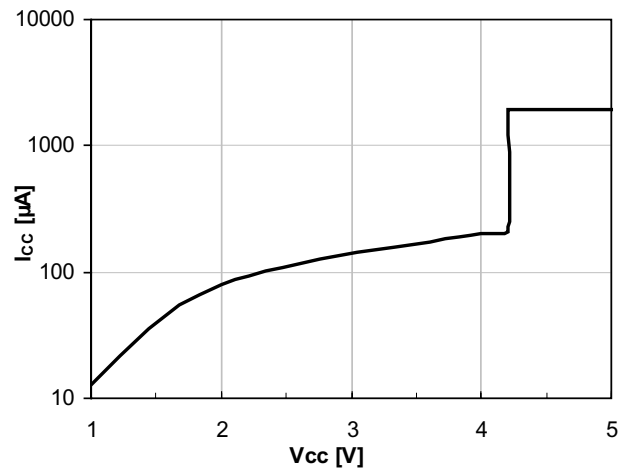

Figure 5. V_{CC} Supply Current (no load)

Typical Transient Characteristics

The transient characterization test set-up shown in Figure 6 includes the effective source impedance of the V_{CC} supply (R_S). This was measured to be approximately 0.1Ω . It is recommended that this effective source impedance be no greater than 0.15Ω to ensure precise switching is maintained during V_{CC} selection and deselection.

Both the rise and fall times during V_{CC} power-up/down sequencing were controlled at a 10 millisecond duration. This is considered to represent worst case conditions for most application circuits.

During a selection or deselection transition, the DC load current is switching from V_{AUX} to V_{CC} and vice versa. In addition to the normal load current, there may also be an in-rush current for charging/discharging the load capacitor.

The total current pulse being applied to either V_{AUX} or V_{CC} is equal to the sum of the DC load and the corresponding in-rush current. Transient currents in excess of 1.0 amps can readily occur for brief intervals when either supply commences to power the load.

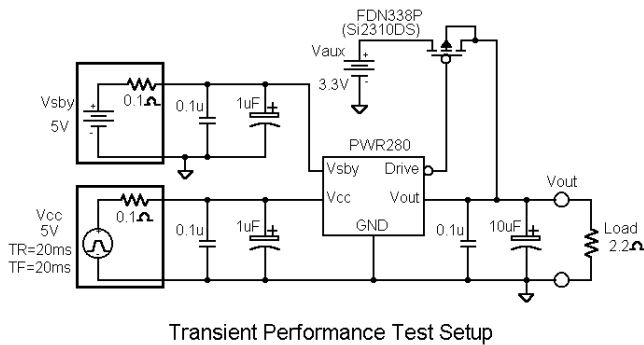

Figure 6. Transient Performance Test Set-up

V_{CC} Load Transient Response is shown in Figure 7 for a step load from 15mA to 1500mA. An overshoot of approximately 300mV is observed, before settling within $3\mu s$.

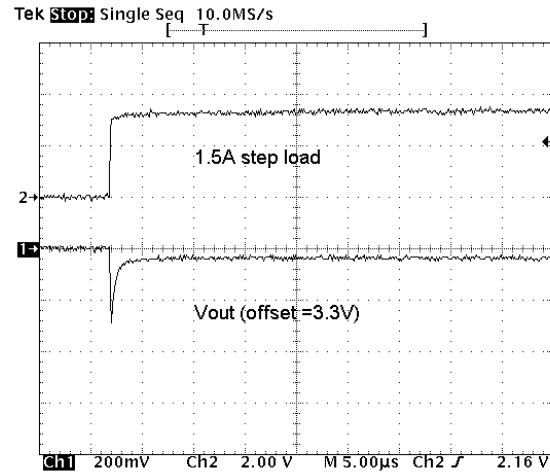

Figure 7. V_{CC} Load Transient Response

V_{SBY} Load Transient Response is shown in Figure 8 is shown for a step load from 5mA to 375mA. An overshoot of approximately 100mV is observed, before settling within $1\mu s$.

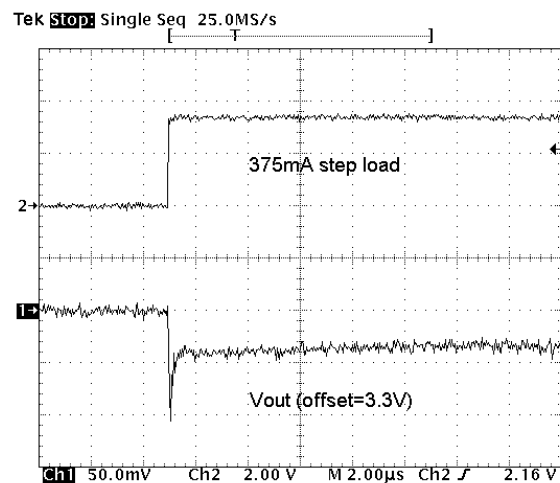

Figure 8. V_{SBY} Load Transient Response

Typical Transient Characteristics (cont'd)

Cold Start and Full Power Down Modes

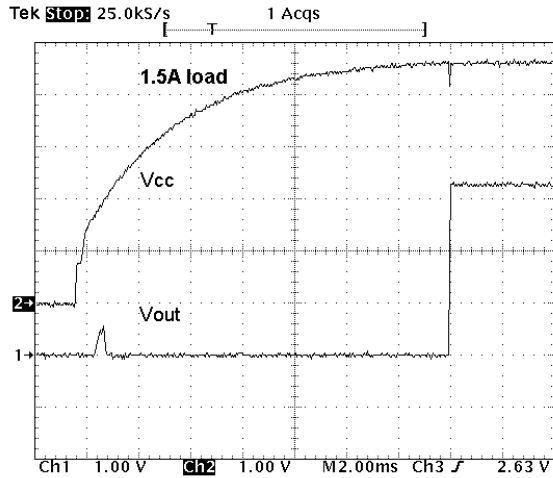

Figure 9. V_{CC} Cold Start

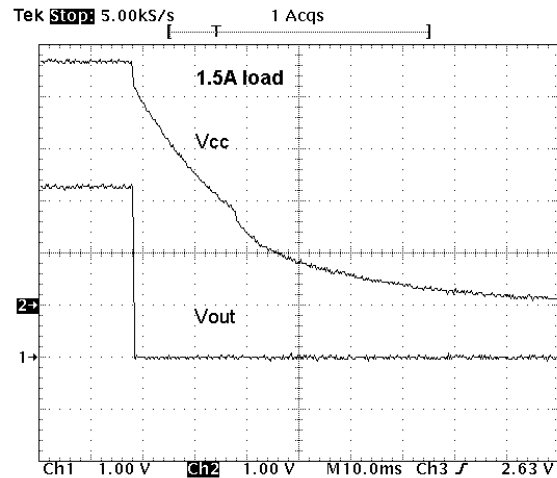

Figure 11. V_{SBY} Cold Start

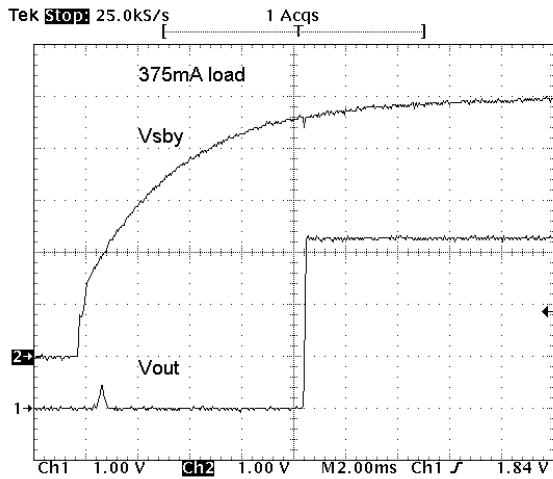

Figure 10. V_{CC} Full Power-down

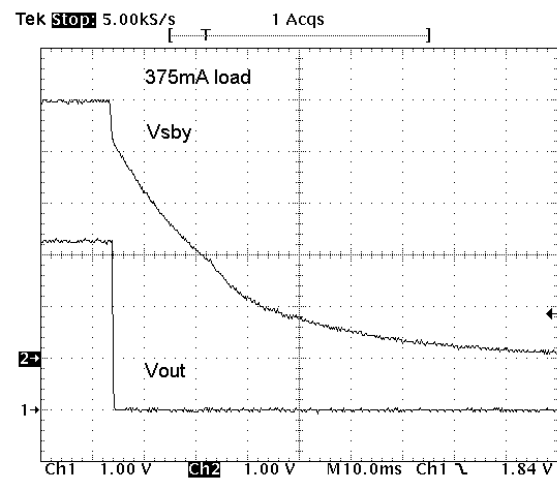

Figure 12. V_{SBY} Full Power Down

Typical Transient Characteristics (cont'd)

VCC Power Changeover Modes

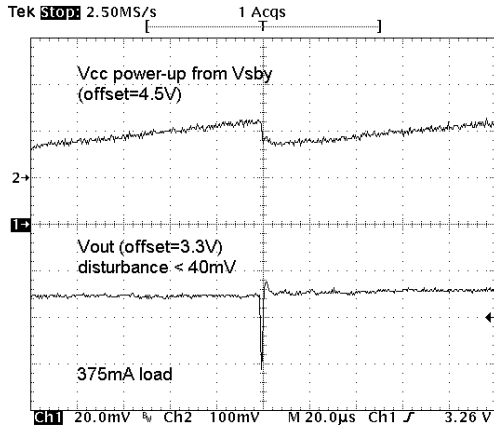

Figure 13. V_{CC} Power Up (V_{SBY} = 5V)

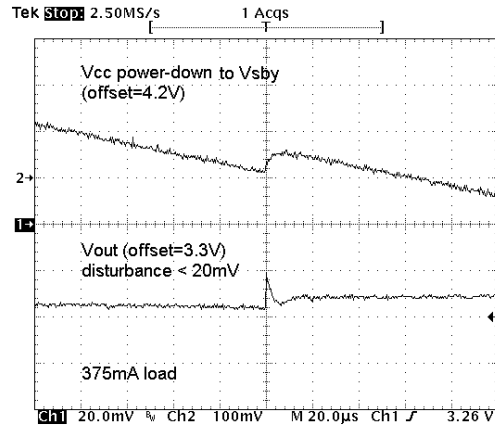

Figure 16. V_{CC} Power Down (V_{SBY} = 5V)

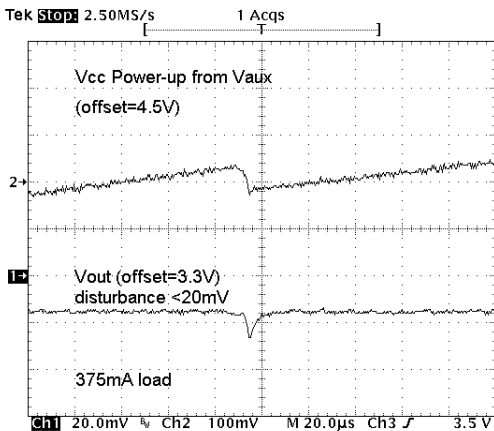

Figure 14. V_{CC} Power Up (V_{AUX} = 3.3V)

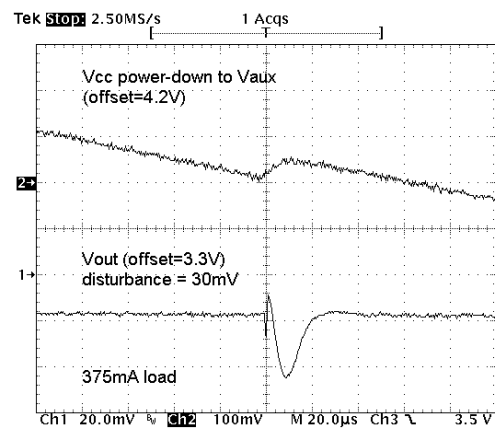

Figure 17. V_{CC} Power Down (V_{AUX} = 3.3V)

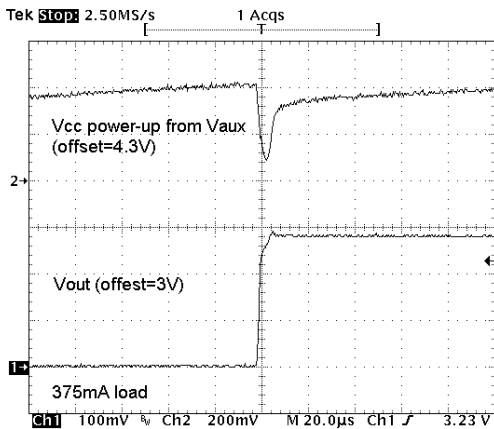

Figure 15. V_{CC} Power Up (V_{AUX} = 3.0V)

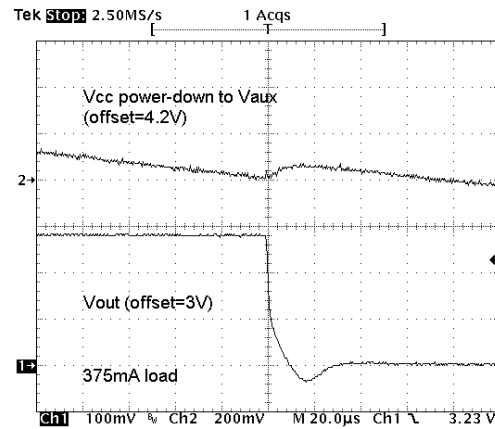

Figure 18. V_{CC} Power Down (V_{AUX} = 3.0V)

Typical Thermal Characteristics

Thermal dissipation of junction heat consists primarily of two paths in series. The first path is the junction to the case (θ_{JC}) thermal resistance which is defined by the package style, and the second path is the case to ambient (θ_{CA}) thermal resistance, which is dependent on board layout.

The overall junction to ambient (θ_{JA}) thermal resistance is equal to:

$$\theta_{JA} = \theta_{JC} + \theta_{CA}$$

For a given package style and board layout, the operating junction temperature is a function of junction power dissipation P_{JUNC} , and the ambient temperature, resulting in the following thermal equation:

$$\begin{aligned} T_{JUNC} &= T_{AMB} + P_{JUNC} (\theta_{JC}) + P_{JUNC} (\theta_{CA}) \\ &= T_{AMB} + P_{JUNC} (\theta_{JA}) \end{aligned}$$

The CMPWR280TO is housed in a TO-263 5-lead package, which provides a θ_{JC} of 3°C/W. The ground tab is soldered down to the PCB. When the device is mounted on a double-sided printed circuit board with two square inches of copper allocated for “heat spreading”, the resulting θ_{JA} is 25°C/W.

Based on a maximum power dissipation of 2.85W (1.9Vx1.5A) with an ambient of 70°C the resulting junction temperature will be:

$$\begin{aligned} T_{JUNC} &= T_{AMB} + P_{JUNC} (\theta_{JA}) \\ &= 70^{\circ}\text{C} + 2.85\text{W} (25^{\circ}\text{C/W}) \\ &= 70^{\circ}\text{C} + 71^{\circ}\text{C} = 141^{\circ}\text{C} \end{aligned}$$

All thermal characteristics of the CMPWR280TO were measured using a double-sided board with two square inches of copper area connected to the GND pins for “heat spreading”.

Measurements showing performance up to junction temperature of 125°C were performed under light load conditions (5mA). This allows the ambient temperature to be representative of the internal junction temperature.

Note: The use of multi-layer board construction with power planes will further enhance the thermal performance of the package. In the event of no copper area being dedicated for heat spreading, a multi-layer board construction will typically provide the CMPWR280TO with an overall θ_{JA} of 25°C/W which allows up to 2.5W to be safely dissipated.

Output Voltage vs. Temperature. Figure 19 shows the regulator V_{OUT} performance up to the maximum rated junction temperature. The overall 125°C variation in junction temperature causes an output voltage change of about 25mV.

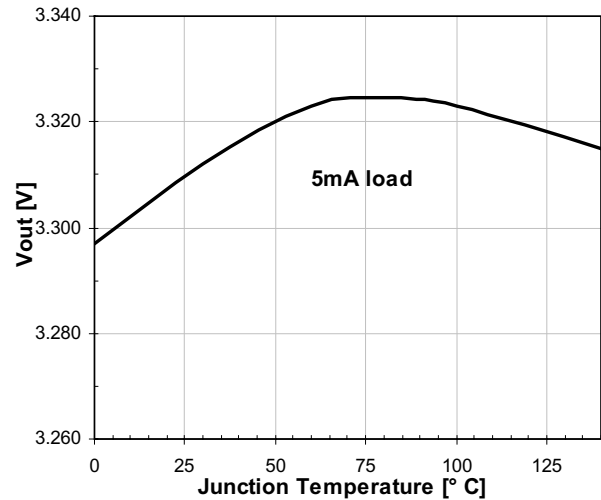

Figure 19. Output Voltage vs. Temperature

Output Voltage (Rated) vs. Temperature. Figure 20 shows the regulator steady state performance when fully loaded (1.5A) in an ambient temperature up to the rated maximum of 70°C. The output variation at maximum load is approximately 13mV across the normal temperature range.

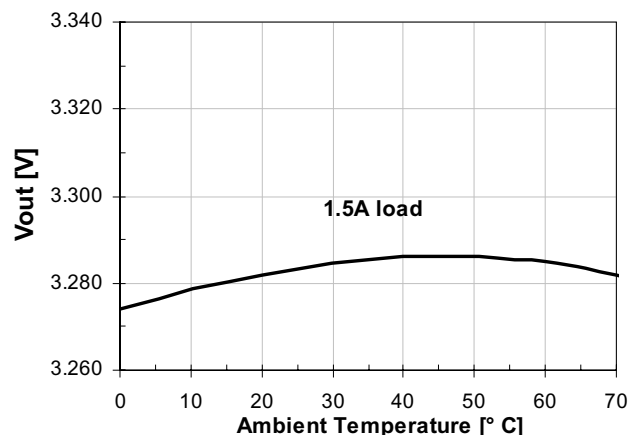

Figure 20. Output Voltage (Rated) vs. Temperature

Typical Thermal Characteristics (cont'd)

Thresholds vs. Temperature. Figure 21 shows the regulator select/deselect threshold variation up to the maximum rated junction temperature. The overall 125°C change in junction temperature causes a 30mV variation in the select threshold voltage (regulator enable). The deselect threshold level varies about 30mV over the 125°C change in junction temperature. This results in the built-in hysteresis having minimal variation over the entire operating junction temperature range.

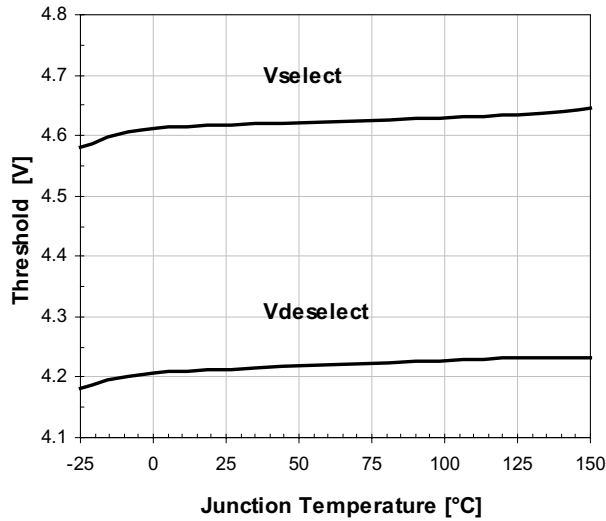

Figure 21. Threshold vs. Temperature

Mechanical Details

The CMPWR280 is available in either a standard 5-lead TO-263 package or a thin-body, 5-lead TO-263 package. The mechanical specifications for each of these packages are presented below.

Standard TO-263-5 Mechanical Specifications

Dimensions for CMPWR280TO devices packaged in 5-lead, standard TO-263 packages are presented below.

PACKAGE DIMENSIONS				
Package	TO-263			
Pins	5			
Dimensions	Millimeters		Inches	
	Min	Max	Min	Max
A	4.34	4.60	0.171	0.181
b	0.74	0.89	0.029	0.035
c	0.33	0.43	0.013	0.017
D	8.92	9.17	0.351	0.361
E	10.16	10.67	0.400	0.420
e	1.70 REF		0.067 REF	
L	14.61	15.88	0.575	0.625
L1	2.29	2.79	0.090	0.110
L2	1.14	1.40	0.045	0.055
M	0.23	0.30	0.009	0.012
P	1.14	1.40	0.045	0.055
S	1.40	1.91	0.055	0.075
# per tube	50 pieces*			
# per tape and reel	750 pieces			
Controlling dimension: inches				

* This is an approximate amount which may vary.

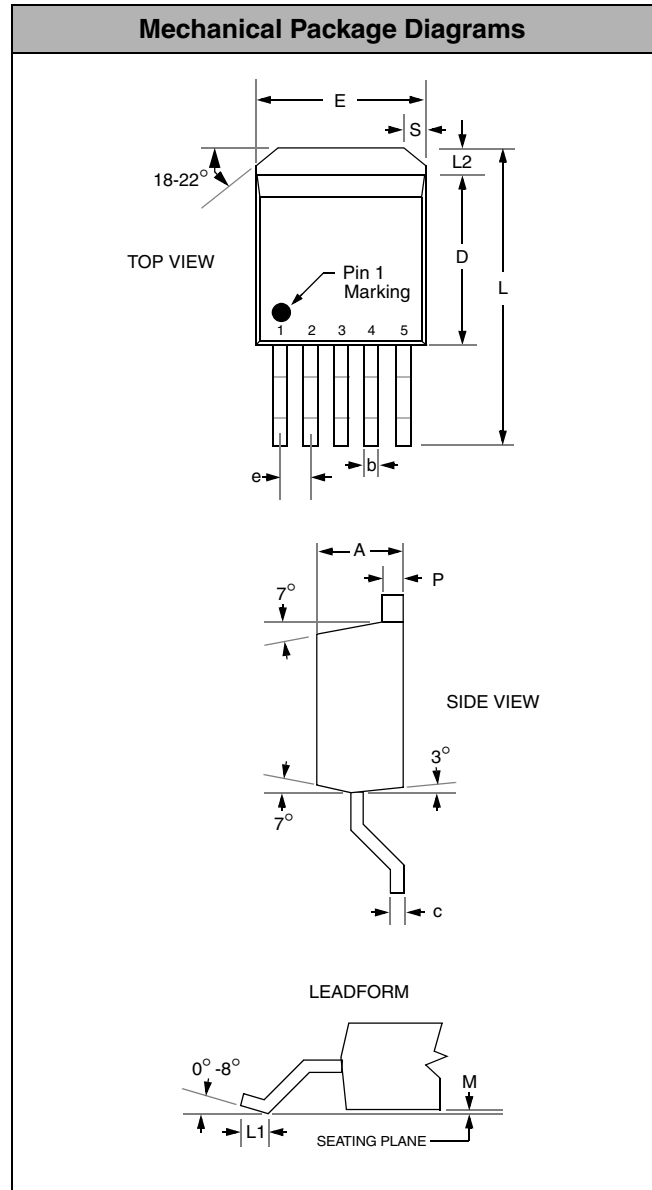

Package Dimensions for Standard TO-263-5.

Mechanical Details (cont'd)

Thin TO-263-5 Mechanical Specifications

Dimensions for CMPWR280TA devices packaged in 5-lead, thin-body TO-263 packages are presented below.

PACKAGE DIMENSIONS				
Package	Thin-body TO-263			
Pins	5			
Dimensions	Millimeters		Inches	
	Min	Max	Min	Max
A	1.270	1.524	0.050	0.060
b	0.635	0.889	0.025	0.035
c	0.228	0.330	0.009	0.013
D	8.890	9.400	0.350	0.370
E	9.779	10.29	0.385	0.405
e	1.709 REF		0.067 REF	
L	14.732	15.75	0.580	0.620
L1	2.286	2.794	0.090	0.110
L2	1.143	1.400	0.045	0.055
M	.000	0.101	.000	.004
P	0.228	0.330	0.009	0.013
S	-	-	-	-
T	5.210	5.460	0.205	0.215
U	7.370	7.620	0.290	0.300
# per tube	50 pieces*			
# per tape and reel	750 pieces			
Controlling dimension: inches				

* This is an approximate amount which may vary.

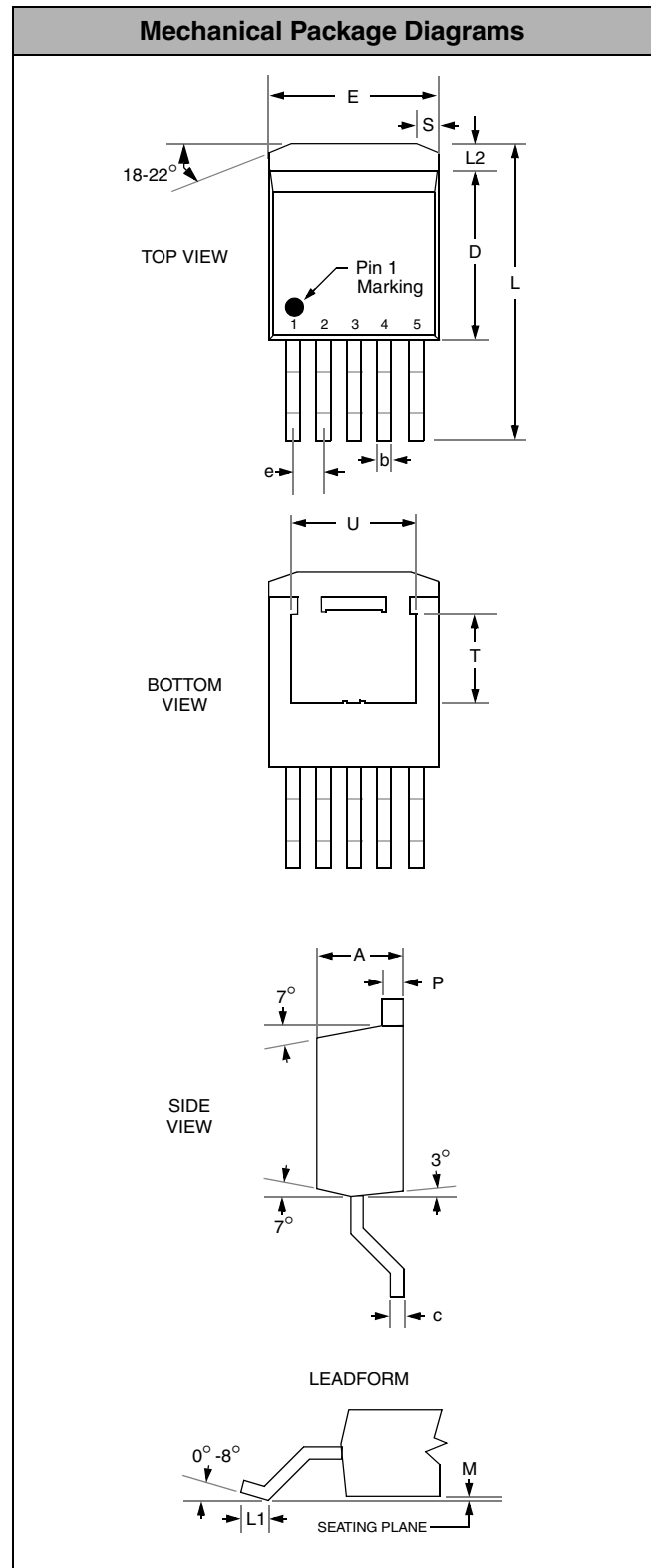

Package Dimensions for Thin TO-263-5.