



2SA1106

PNP PLANAR SILICON TRANSISTOR

**AUDIO POWER AMPLIFIER
DC TO DC CONVERTER**

- High Current Capability
- High Power Dissipation
- Complementary to 2SC2581

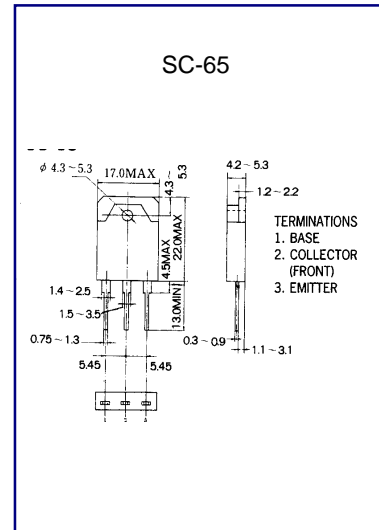

ABSOLUTE MAXIMUM RATING ($T_a=25^\circ\text{C}$)

Characteristic	Symbol	Rating	Unit
Collector-Base Voltage	VCBO	-200	V
Collector-Emitter Voltage	VCEO	-140	V
Emitter-Base voltage	VEBO	-6	V
Collector Current (DC)	IC	-10	A
Collector Dissipation	PC	100	W
Junction Temperature	Tj	150	$^\circ\text{C}$
Storage Temperature	Tstg	-55~150	$^\circ\text{C}$

ELECTRICAL CHARACTERISTICS ($T_a=25^\circ\text{C}$)

Characteristic	Symbol	Test Condition	Min	Typ	Max	Unit
Collector Base Breakdown Voltage	BVCBO	IC=-5 mA IE=0	-200			V
Collector Emitter Breakdown Voltage	BVCEO	IC=-10 mA	-140			V
Emitter Base Breakdown Voltage	BVEBO	RBE= ∞	-6			V
Collector Cutoff Current	ICBO	IE=-5mA IC=0			-0.1	mA
Emitter Cutoff Current	IEBO	VCB=-100V IE=0			-0.1	mA
*DC Current Gain	hFE1	VEB=-4V IC=0	55		160	
DC Current Gain	hFE2	VCE=-5V IC=-1A	50			
Collector- Emitter Saturation Voltage	VCE(sat)	VCE=-5V IC=-5A IC=-5A IB=-0.5A			-2.0	V